



Chipsmall Limited consists of a professional team with an average of over 10 year of expertise in the distribution of electronic components. Based in Hongkong, we have already established firm and mutual-benefit business relationships with customers from,Europe,America and south Asia,supplying obsolete and hard-to-find components to meet their specific needs.

With the principle of “Quality Parts,Customers Priority,Honest Operation,and Considerate Service”,our business mainly focus on the distribution of electronic components. Line cards we deal with include Microchip,ALPS,ROHM,Xilinx,Pulse,ON,Everlight and Freescale. Main products comprise IC,Modules,Potentiometer,IC Socket,Relay,Connector.Our parts cover such applications as commercial,industrial, and automotives areas.

We are looking forward to setting up business relationship with you and hope to provide you with the best service and solution. Let us make a better world for our industry!



Contact us

Tel: +86-755-8981 8866 Fax: +86-755-8427 6832

Email & Skype: info@chipsmall.com Web: www.chipsmall.com

Address: A1208, Overseas Decoration Building, #122 Zhenhua RD., Futian, Shenzhen, China



74HC4051; 74HCT4051

8-channel analog multiplexer/demultiplexer

Rev. 8 — 5 February 2016

Product data sheet

1. General description

The 74HC4051; 74HCT4051 is a single-pole octal-throw analog switch (SP8T) suitable for use in analog or digital 8:1 multiplexer/demultiplexer applications. The switch features three digital select inputs (S0, S1 and S2), eight independent inputs/outputs (Yn), a common input/output (Z) and a digital enable input (\bar{E}). When \bar{E} is HIGH, the switches are turned off. Inputs include clamp diodes. This enables the use of current limiting resistors to interface inputs to voltages in excess of V_{CC} .

2. Features and benefits

- Wide analog input voltage range from -5 V to $+5\text{ V}$
- Complies with JEDEC standard no. 7A
- Low ON resistance:
 - ◆ $80\ \Omega$ (typical) at $V_{CC} - V_{EE} = 4.5\text{ V}$
 - ◆ $70\ \Omega$ (typical) at $V_{CC} - V_{EE} = 6.0\text{ V}$
 - ◆ $60\ \Omega$ (typical) at $V_{CC} - V_{EE} = 9.0\text{ V}$
- Logic level translation: to enable 5 V logic to communicate with $\pm 5\text{ V}$ analog signals
- Typical 'break before make' built-in
- ESD protection:
 - ◆ HBM JESD22-A114F exceeds 2000 V
 - ◆ MM JESD22-A115-A exceeds 200 V
 - ◆ CDM JESD22-C101E exceeds 1000 V
- Multiple package options
- Specified from $-40\text{ }^\circ\text{C}$ to $+85\text{ }^\circ\text{C}$ and $-40\text{ }^\circ\text{C}$ to $+125\text{ }^\circ\text{C}$

3. Applications

- Analog multiplexing and demultiplexing
- Digital multiplexing and demultiplexing
- Signal gating

4. Ordering information

Table 1. Ordering information

Type number	Package			Version
	Temperature range	Name	Description	
74HC4051D	-40 °C to +125 °C	SO16	plastic small outline package; 16 leads; body width 3.9 mm	SOT109-1
74HCT4051D				
74HC4051DB	-40 °C to +125 °C	SSOP16	plastic shrink small outline package; 16 leads; body width 5.3 mm	SOT338-1
74HCT4051DB				
74HC4051PW	-40 °C to +125 °C	TSSOP16	plastic thin shrink small outline package; 16 leads; body width 4.4 mm	SOT403-1
74HCT4051PW				
74HC4051BQ	-40 °C to +125 °C	DHVQFN16	plastic dual in-line compatible thermal enhanced very thin quad flat package; no leads; 16 terminals; body 2.5 × 3.5 × 0.85 mm	SOT763-1
74HCT4051BQ				

5. Functional diagram

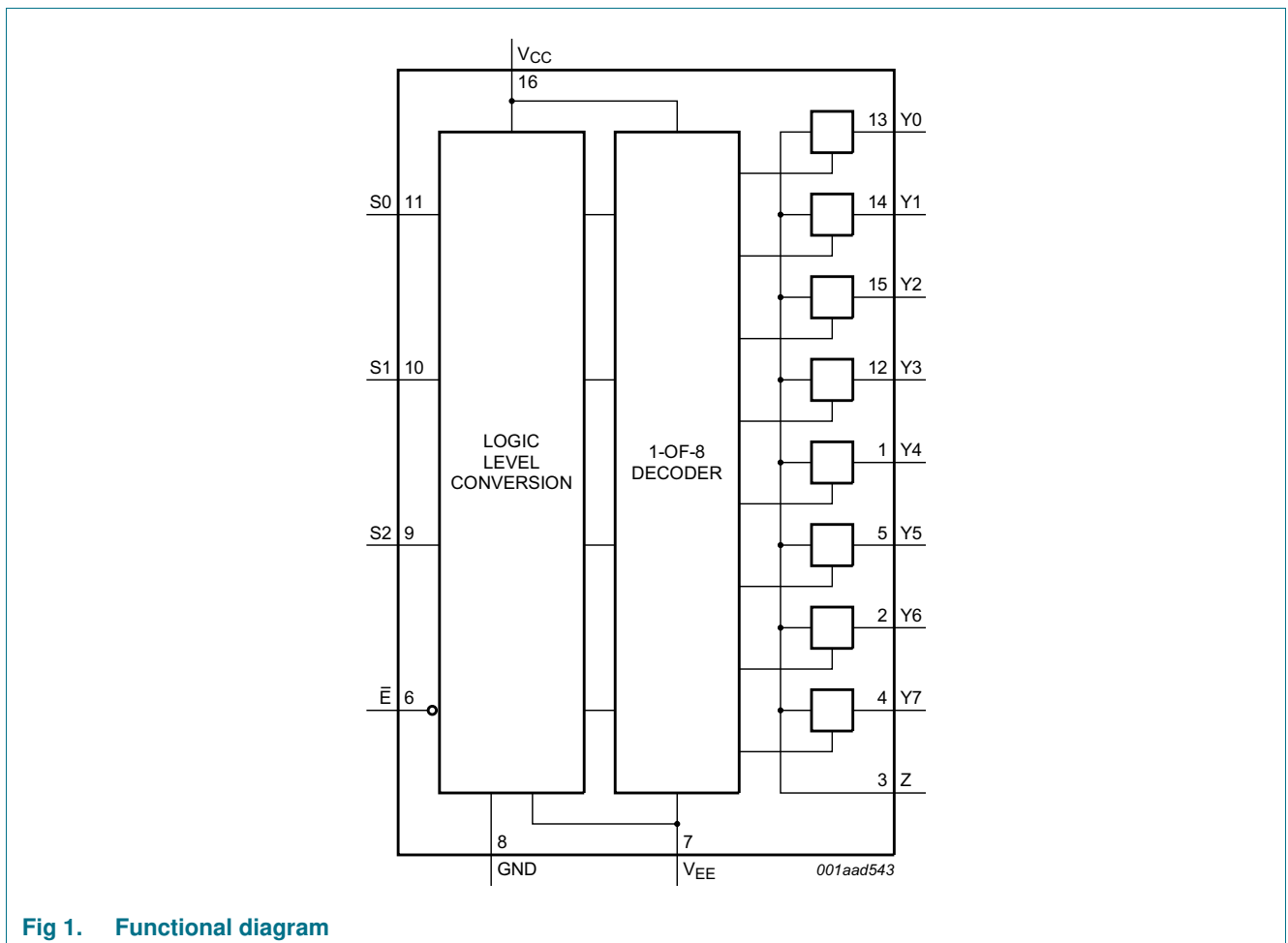

Fig 1. Functional diagram

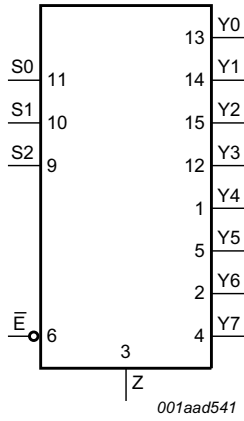

Fig 2. Logic symbol

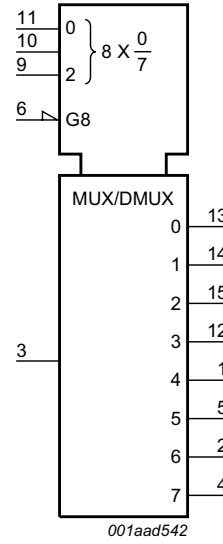

Fig 3. IEC logic symbol

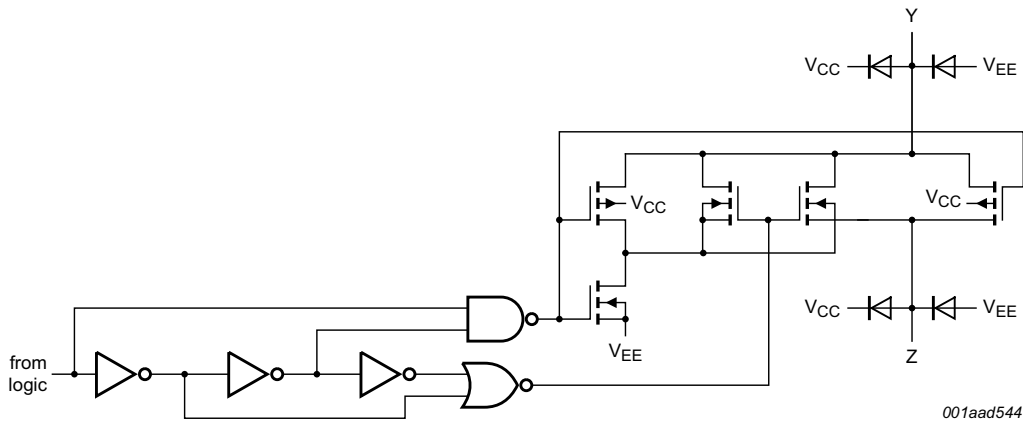
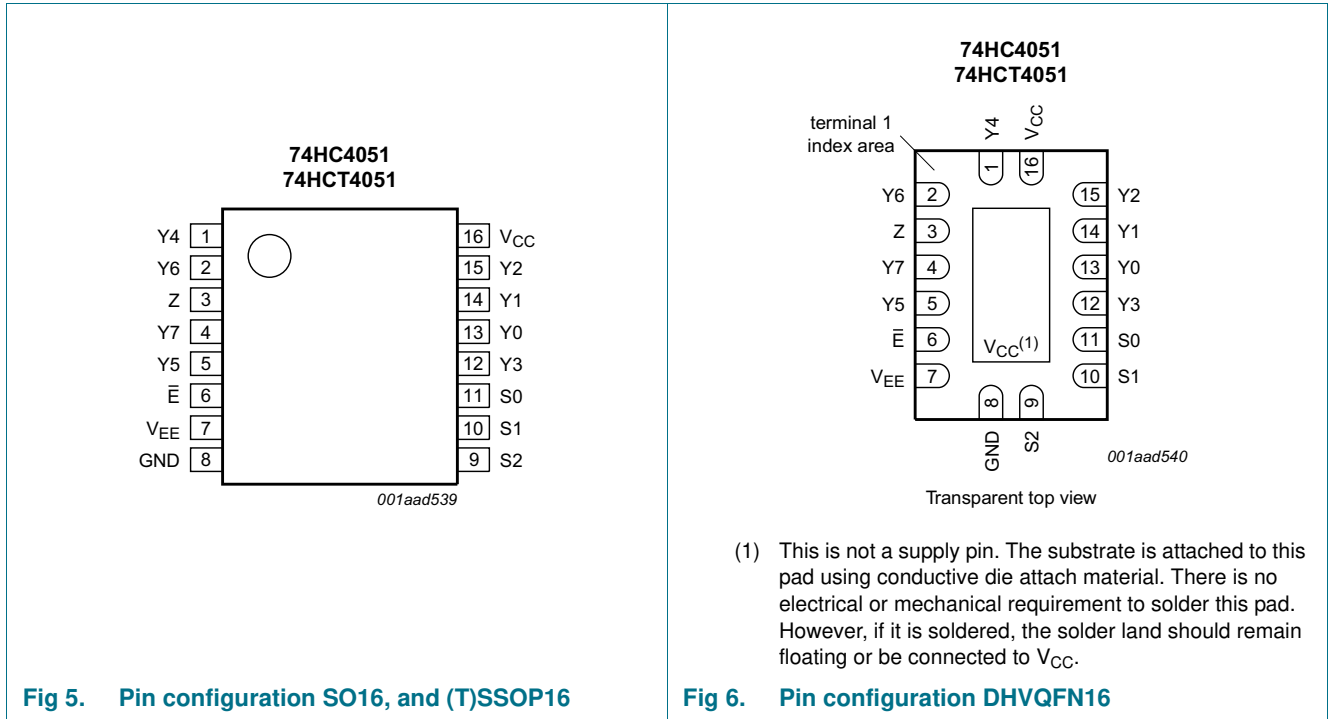

Fig 4. Schematic diagram (one switch)

6. Pinning information

6.1 Pinning



6.2 Pin description

Table 2. Pin description

Symbol	Pin	Description
\bar{E}	6	enable input (active LOW)
V _{EE}	7	supply voltage
GND	8	ground supply voltage
S0, S1, S2	11, 10, 9	select input
Y0, Y1, Y2, Y3, Y4, Y5, Y6, Y7	13, 14, 15, 12, 1, 5, 2, 4	independent input or output
Z	3	common output or input
V _{CC}	16	supply voltage

7. Functional description

7.1 Function table

Table 3. Function table^[1]

Input				Channel ON
E	S2	S1	S0	
L	L	L	L	Y0 to Z
L	L	L	H	Y1 to Z
L	L	H	L	Y2 to Z
L	L	H	H	Y3 to Z
L	H	L	L	Y4 to Z
L	H	L	H	Y5 to Z
L	H	H	L	Y6 to Z
L	H	H	H	Y7 to Z
H	X	X	X	switches off

- [1] H = HIGH voltage level;
L = LOW voltage level;
X = don't care.

8. Limiting values

Table 4. Limiting values

In accordance with the Absolute Maximum Rating System (IEC 60134). Voltages are referenced to $V_{SS} = 0$ V (ground).

Symbol	Parameter	Conditions	Min	Max	Unit
V_{CC}	supply voltage		-0.5	+11.0	V
I_{IK}	input clamping current	$V_I < -0.5$ V or $V_I > V_{CC} + 0.5$ V	-	± 20	mA
I_{SK}	switch clamping current	$V_{SW} < -0.5$ V or $V_{SW} > V_{CC} + 0.5$ V	-	± 20	mA
I_{SW}	switch current	-0.5 V $< V_{SW} < V_{CC} + 0.5$ V	-	± 25	mA
I_{EE}	supply current		-	± 20	mA
I_{CC}	supply current		-	50	mA
I_{GND}	ground current		-	-50	mA
T_{stg}	storage temperature		-65	+150	°C
P_{tot}	total power dissipation	SO16, (T)SSOP16, and DHVQFN16 package	-	500	mW
P	power dissipation	per switch	-	100	mW

- [1] To avoid drawing V_{CC} current out of terminal Z, when switch current flows into terminals Y_n , the voltage drop across the bidirectional switch must not exceed 0.4 V. If the switch current flows into terminal Z, no V_{CC} current will flow out of terminals Y_n , and in this case there is no limit for the voltage drop across the switch, but the voltages at Y_n and Z may not exceed V_{CC} or V_{EE} .
- [2] For SO16 packages: above 70 °C the value of P_{tot} derates linearly with 8 mW/K.
For SSOP16 and TSSOP16 packages: above 60 °C the value of P_{tot} derates linearly with 5.5 mW/K.
For DHVQFN16 packages: above 60 °C the value of P_{tot} derates linearly with 4.5 mW/K.

9. Recommended operating conditions

Table 5. Recommended operating conditions

Symbol	Parameter	Conditions	74HC4051			74HCT4051			Unit
			Min	Typ	Max	Min	Typ	Max	
V _{CC}	supply voltage	see Figure 7 and Figure 8							
		V _{CC} – GND	2.0	5.0	10.0	4.5	5.0	5.5	V
		V _{CC} – V _{EE}	2.0	5.0	10.0	2.0	5.0	10.0	V
V _I	input voltage		GND	-	V _{CC}	GND	-	V _{CC}	V
V _{SW}	switch voltage		V _{EE}	-	V _{CC}	V _{EE}	-	V _{CC}	V
T _{amb}	ambient temperature		-40	+25	+125	-40	+25	+125	°C
Δt/ΔV	input transition rise and fall rate	V _{CC} = 2.0 V	-	-	625	-	-	-	ns/V
		V _{CC} = 4.5 V	-	1.67	139	-	1.67	139	ns/V
		V _{CC} = 6.0 V	-	-	83	-	-	-	ns/V
		V _{CC} = 10.0 V	-	-	31	-	-	-	ns/V

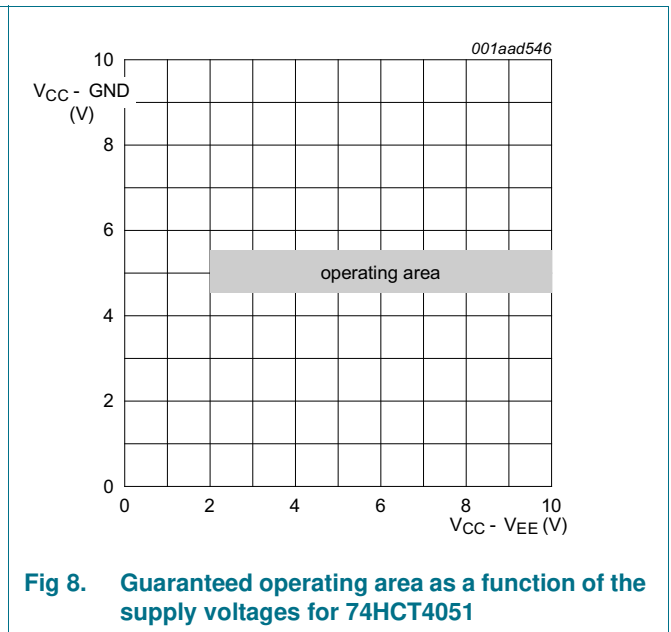
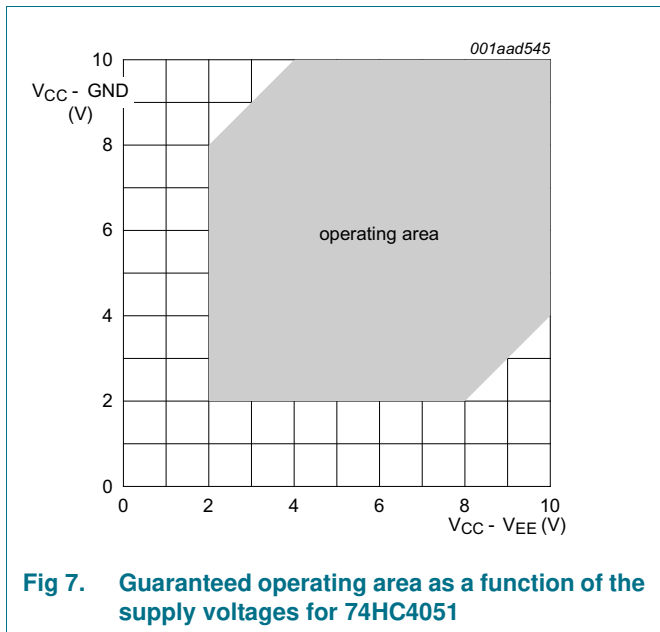

10. Static characteristics

Table 6. R_{ON} resistance per switch for 74HC4051 and 74HCT4051

$V_I = V_{IH}$ or V_{IL} ; for test circuit see [Figure 9](#).

V_{is} is the input voltage at a Yn or Z terminal, whichever is assigned as an input.

V_{os} is the output voltage at a Yn or Z terminal, whichever is assigned as an output.

For 74HC4051: $V_{CC} - GND$ or $V_{CC} - V_{EE} = 2.0\text{ V}$, 4.5 V , 6.0 V and 9.0 V .

For 74HCT4051: $V_{CC} - GND = 4.5\text{ V}$ and 5.5 V , $V_{CC} - V_{EE} = 2.0\text{ V}$, 4.5 V , 6.0 V and 9.0 V .

Symbol	Parameter	Conditions	Min	Typ	Max	Unit	
$T_{amb} = 25\text{ °C}$							
$R_{ON(peak)}$	ON resistance (peak)	$V_{is} = V_{CC}$ to V_{EE}					
		$V_{CC} = 2.0\text{ V}$; $V_{EE} = 0\text{ V}$; $I_{SW} = 100\text{ }\mu\text{A}$	[1]	-	-	-	Ω
		$V_{CC} = 4.5\text{ V}$; $V_{EE} = 0\text{ V}$; $I_{SW} = 1000\text{ }\mu\text{A}$		-	100	180	Ω
		$V_{CC} = 6.0\text{ V}$; $V_{EE} = 0\text{ V}$; $I_{SW} = 1000\text{ }\mu\text{A}$		-	90	160	Ω
		$V_{CC} = 4.5\text{ V}$; $V_{EE} = -4.5\text{ V}$; $I_{SW} = 1000\text{ }\mu\text{A}$		-	70	130	Ω
$R_{ON(rail)}$	ON resistance (rail)	$V_{is} = V_{EE}$					
		$V_{CC} = 2.0\text{ V}$; $V_{EE} = 0\text{ V}$; $I_{SW} = 100\text{ }\mu\text{A}$	[1]	-	150	-	Ω
		$V_{CC} = 4.5\text{ V}$; $V_{EE} = 0\text{ V}$; $I_{SW} = 1000\text{ }\mu\text{A}$		-	80	140	Ω
		$V_{CC} = 6.0\text{ V}$; $V_{EE} = 0\text{ V}$; $I_{SW} = 1000\text{ }\mu\text{A}$		-	70	120	Ω
		$V_{CC} = 4.5\text{ V}$; $V_{EE} = -4.5\text{ V}$; $I_{SW} = 1000\text{ }\mu\text{A}$		-	60	105	Ω
		$V_{is} = V_{CC}$					
		$V_{CC} = 2.0\text{ V}$; $V_{EE} = 0\text{ V}$; $I_{SW} = 100\text{ }\mu\text{A}$	[1]	-	150	-	Ω
		$V_{CC} = 4.5\text{ V}$; $V_{EE} = 0\text{ V}$; $I_{SW} = 1000\text{ }\mu\text{A}$		-	90	160	Ω
		$V_{CC} = 6.0\text{ V}$; $V_{EE} = 0\text{ V}$; $I_{SW} = 1000\text{ }\mu\text{A}$		-	80	140	Ω
		$V_{CC} = 4.5\text{ V}$; $V_{EE} = -4.5\text{ V}$; $I_{SW} = 1000\text{ }\mu\text{A}$		-	65	120	Ω
ΔR_{ON}	ON resistance mismatch between channels	$V_{is} = V_{CC}$ to V_{EE}					
		$V_{CC} = 2.0\text{ V}$; $V_{EE} = 0\text{ V}$	[1]	-	-	-	Ω
		$V_{CC} = 4.5\text{ V}$; $V_{EE} = 0\text{ V}$		-	9	-	Ω
		$V_{CC} = 6.0\text{ V}$; $V_{EE} = 0\text{ V}$		-	8	-	Ω
		$V_{CC} = 4.5\text{ V}$; $V_{EE} = -4.5\text{ V}$		-	6	-	Ω
$T_{amb} = -40\text{ °C}$ to $+85\text{ °C}$							
$R_{ON(peak)}$	ON resistance (peak)	$V_{is} = V_{CC}$ to V_{EE}					
		$V_{CC} = 2.0\text{ V}$; $V_{EE} = 0\text{ V}$; $I_{SW} = 100\text{ }\mu\text{A}$	[1]	-	-	-	Ω
		$V_{CC} = 4.5\text{ V}$; $V_{EE} = 0\text{ V}$; $I_{SW} = 1000\text{ }\mu\text{A}$		-	-	225	Ω
		$V_{CC} = 6.0\text{ V}$; $V_{EE} = 0\text{ V}$; $I_{SW} = 1000\text{ }\mu\text{A}$		-	-	200	Ω
		$V_{CC} = 4.5\text{ V}$; $V_{EE} = -4.5\text{ V}$; $I_{SW} = 1000\text{ }\mu\text{A}$		-	-	165	Ω

Table 6. R_{ON} resistance per switch for 74HC4051 and 74HCT4051 ...continued

$V_I = V_{IH}$ or V_{IL} ; for test circuit see [Figure 9](#).

V_{is} is the input voltage at a Yn or Z terminal, whichever is assigned as an input.

V_{os} is the output voltage at a Yn or Z terminal, whichever is assigned as an output.

For 74HC4051: $V_{CC} - GND$ or $V_{CC} - V_{EE} = 2.0\text{ V}$, 4.5 V , 6.0 V and 9.0 V .

For 74HCT4051: $V_{CC} - GND = 4.5\text{ V}$ and 5.5 V , $V_{CC} - V_{EE} = 2.0\text{ V}$, 4.5 V , 6.0 V and 9.0 V .

Symbol	Parameter	Conditions	Min	Typ	Max	Unit	
$R_{ON(rail)}$	ON resistance (rail)	$V_{is} = V_{EE}$					
		$V_{CC} = 2.0\text{ V}$; $V_{EE} = 0\text{ V}$; $I_{SW} = 100\text{ }\mu\text{A}$	[1]	-	-	-	Ω
		$V_{CC} = 4.5\text{ V}$; $V_{EE} = 0\text{ V}$; $I_{SW} = 1000\text{ }\mu\text{A}$		-	-	175	Ω
		$V_{CC} = 6.0\text{ V}$; $V_{EE} = 0\text{ V}$; $I_{SW} = 1000\text{ }\mu\text{A}$		-	-	150	Ω
		$V_{CC} = 4.5\text{ V}$; $V_{EE} = -4.5\text{ V}$; $I_{SW} = 1000\text{ }\mu\text{A}$		-	-	130	Ω
		$V_{is} = V_{CC}$					
		$V_{CC} = 2.0\text{ V}$; $V_{EE} = 0\text{ V}$; $I_{SW} = 100\text{ }\mu\text{A}$	[1]	-	-	-	Ω
		$V_{CC} = 4.5\text{ V}$; $V_{EE} = 0\text{ V}$; $I_{SW} = 1000\text{ }\mu\text{A}$		-	-	200	Ω
		$V_{CC} = 6.0\text{ V}$; $V_{EE} = 0\text{ V}$; $I_{SW} = 1000\text{ }\mu\text{A}$		-	-	175	Ω
		$V_{CC} = 4.5\text{ V}$; $V_{EE} = -4.5\text{ V}$; $I_{SW} = 1000\text{ }\mu\text{A}$		-	-	150	Ω
$T_{amb} = -40\text{ }^\circ\text{C}$ to $+125\text{ }^\circ\text{C}$							
$R_{ON(peak)}$	ON resistance (peak)	$V_{is} = V_{CC}$ to V_{EE}					
		$V_{CC} = 2.0\text{ V}$; $V_{EE} = 0\text{ V}$; $I_{SW} = 100\text{ }\mu\text{A}$	[1]	-	-	-	Ω
		$V_{CC} = 4.5\text{ V}$; $V_{EE} = 0\text{ V}$; $I_{SW} = 1000\text{ }\mu\text{A}$		-	-	270	Ω
		$V_{CC} = 6.0\text{ V}$; $V_{EE} = 0\text{ V}$; $I_{SW} = 1000\text{ }\mu\text{A}$		-	-	240	Ω
		$V_{CC} = 4.5\text{ V}$; $V_{EE} = -4.5\text{ V}$; $I_{SW} = 1000\text{ }\mu\text{A}$		-	-	195	Ω
$R_{ON(rail)}$	ON resistance (rail)	$V_{is} = V_{EE}$					
		$V_{CC} = 2.0\text{ V}$; $V_{EE} = 0\text{ V}$; $I_{SW} = 100\text{ }\mu\text{A}$	[1]	-	-	-	Ω
		$V_{CC} = 4.5\text{ V}$; $V_{EE} = 0\text{ V}$; $I_{SW} = 1000\text{ }\mu\text{A}$		-	-	210	Ω
		$V_{CC} = 6.0\text{ V}$; $V_{EE} = 0\text{ V}$; $I_{SW} = 1000\text{ }\mu\text{A}$		-	-	180	Ω
		$V_{CC} = 4.5\text{ V}$; $V_{EE} = -4.5\text{ V}$; $I_{SW} = 1000\text{ }\mu\text{A}$		-	-	160	Ω
		$V_{is} = V_{CC}$					
		$V_{CC} = 2.0\text{ V}$; $V_{EE} = 0\text{ V}$; $I_{SW} = 100\text{ }\mu\text{A}$	[1]	-	-	-	Ω
		$V_{CC} = 4.5\text{ V}$; $V_{EE} = 0\text{ V}$; $I_{SW} = 1000\text{ }\mu\text{A}$		-	-	240	Ω
		$V_{CC} = 6.0\text{ V}$; $V_{EE} = 0\text{ V}$; $I_{SW} = 1000\text{ }\mu\text{A}$		-	-	210	Ω
		$V_{CC} = 4.5\text{ V}$; $V_{EE} = -4.5\text{ V}$; $I_{SW} = 1000\text{ }\mu\text{A}$		-	-	180	Ω

[1] When supply voltages ($V_{CC} - V_{EE}$) near 2.0 V the analog switch ON resistance becomes extremely non-linear. When using a supply of 2 V , it is recommended to use these devices only for transmitting digital signals.

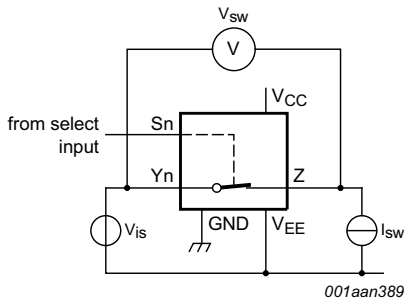

$V_{is} = 0 \text{ V to } (V_{CC} - V_{EE}).$

$$R_{ON} = \frac{V_{sw}}{I_{sw}}$$

Fig 9. Test circuit for measuring R_{ON}

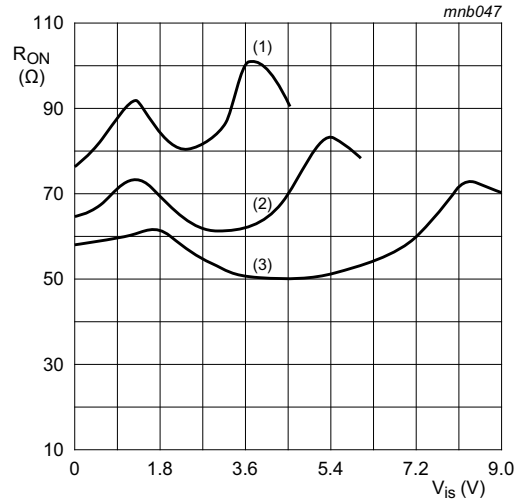

$V_{is} = 0 \text{ V to } (V_{CC} - V_{EE}).$

- (1) $V_{CC} = 4.5 \text{ V}$
- (2) $V_{CC} = 6 \text{ V}$
- (3) $V_{CC} = 9 \text{ V}$

Fig 10. Typical R_{ON} as a function of input voltage V_{is}

Table 7. Static characteristics for 74HC4051

Voltages are referenced to GND (ground = 0 V).

V_{is} is the input voltage at pins Y_n or Z , whichever is assigned as an input.

V_{os} is the output voltage at pins Z or Y_n , whichever is assigned as an output.

Symbol	Parameter	Conditions	Min	Typ	Max	Unit
$T_{amb} = 25 \text{ }^\circ\text{C}$						
V_{IH}	HIGH-level input voltage	$V_{CC} = 2.0 \text{ V}$	1.5	1.2	-	V
		$V_{CC} = 4.5 \text{ V}$	3.15	2.4	-	V
		$V_{CC} = 6.0 \text{ V}$	4.2	3.2	-	V
		$V_{CC} = 9.0 \text{ V}$	6.3	4.7	-	V
V_{IL}	LOW-level input voltage	$V_{CC} = 2.0 \text{ V}$	-	0.8	0.5	V
		$V_{CC} = 4.5 \text{ V}$	-	2.1	1.35	V
		$V_{CC} = 6.0 \text{ V}$	-	2.8	1.8	V
		$V_{CC} = 9.0 \text{ V}$	-	4.3	2.7	V
I_I	input leakage current	$V_{EE} = 0 \text{ V}; V_I = V_{CC} \text{ or GND}$				
		$V_{CC} = 6.0 \text{ V}$	-	-	± 0.1	μA
		$V_{CC} = 10.0 \text{ V}$	-	-	± 0.2	μA
$I_{S(OFF)}$	OFF-state leakage current	$V_{CC} = 10.0 \text{ V}; V_{EE} = 0 \text{ V}; V_I = V_{IH} \text{ or } V_{IL}; V_{SW} = V_{CC} - V_{EE};$ see Figure 11				
		per channel	-	-	± 0.1	μA
		all channels	-	-	± 0.4	μA
$I_{S(ON)}$	ON-state leakage current	$V_I = V_{IH} \text{ or } V_{IL}; V_{SW} = V_{CC} - V_{EE}; V_{CC} = 10.0 \text{ V}; V_{EE} = 0 \text{ V};$ see Figure 12	-	-	± 0.4	μA

Table 7. Static characteristics for 74HC4051 ...continued

Voltages are referenced to GND (ground = 0 V).

V_{is} is the input voltage at pins Y_n or Z , whichever is assigned as an input.

V_{os} is the output voltage at pins Z or Y_n , whichever is assigned as an output.

Symbol	Parameter	Conditions	Min	Typ	Max	Unit
I_{CC}	supply current	$V_{EE} = 0\text{ V}$; $V_I = V_{CC}$ or GND; $V_{is} = V_{EE}$ or V_{CC} ; $V_{os} = V_{CC}$ or V_{EE}				
		$V_{CC} = 6.0\text{ V}$	-	-	8.0	μA
		$V_{CC} = 10.0\text{ V}$	-	-	16.0	μA
C_I	input capacitance		-	3.5	-	pF
C_{sw}	switch capacitance	independent pins Y_n	-	5	-	pF
		common pins Z	-	25	-	pF
$T_{amb} = -40\text{ }^\circ\text{C}$ to $+85\text{ }^\circ\text{C}$						
V_{IH}	HIGH-level input voltage	$V_{CC} = 2.0\text{ V}$	1.5	-	-	V
		$V_{CC} = 4.5\text{ V}$	3.15	-	-	V
		$V_{CC} = 6.0\text{ V}$	4.2	-	-	V
		$V_{CC} = 9.0\text{ V}$	6.3	-	-	V
V_{IL}	LOW-level input voltage	$V_{CC} = 2.0\text{ V}$	-	-	0.5	V
		$V_{CC} = 4.5\text{ V}$	-	-	1.35	V
		$V_{CC} = 6.0\text{ V}$	-	-	1.8	V
		$V_{CC} = 9.0\text{ V}$	-	-	2.7	V
I_I	input leakage current	$V_{EE} = 0\text{ V}$; $V_I = V_{CC}$ or GND				
		$V_{CC} = 6.0\text{ V}$	-	-	± 1.0	μA
		$V_{CC} = 10.0\text{ V}$	-	-	± 2.0	μA
$I_{S(OFF)}$	OFF-state leakage current	$V_{CC} = 10.0\text{ V}$; $V_{EE} = 0\text{ V}$; $V_I = V_{IH}$ or V_{IL} ; $ V_{SW} = V_{CC} - V_{EE}$; see Figure 11				
		per channel	-	-	± 1.0	μA
		all channels	-	-	± 4.0	μA
$I_{S(ON)}$	ON-state leakage current	$V_I = V_{IH}$ or V_{IL} ; $ V_{SW} = V_{CC} - V_{EE}$; $V_{CC} = 10.0\text{ V}$; $V_{EE} = 0\text{ V}$; see Figure 12	-	-	± 4.0	μA
I_{CC}	supply current	$V_{EE} = 0\text{ V}$; $V_I = V_{CC}$ or GND; $V_{is} = V_{EE}$ or V_{CC} ; $V_{os} = V_{CC}$ or V_{EE}				
		$V_{CC} = 6.0\text{ V}$	-	-	80.0	μA
		$V_{CC} = 10.0\text{ V}$	-	-	160.0	μA
$T_{amb} = -40\text{ }^\circ\text{C}$ to $+125\text{ }^\circ\text{C}$						
V_{IH}	HIGH-level input voltage	$V_{CC} = 2.0\text{ V}$	1.5	-	-	V
		$V_{CC} = 4.5\text{ V}$	3.15	-	-	V
		$V_{CC} = 6.0\text{ V}$	4.2	-	-	V
		$V_{CC} = 9.0\text{ V}$	6.3	-	-	V
V_{IL}	LOW-level input voltage	$V_{CC} = 2.0\text{ V}$	-	-	0.5	V
		$V_{CC} = 4.5\text{ V}$	-	-	1.35	V
		$V_{CC} = 6.0\text{ V}$	-	-	1.8	V
		$V_{CC} = 9.0\text{ V}$	-	-	2.7	V

Table 7. Static characteristics for 74HC4051 ...continued

Voltages are referenced to GND (ground = 0 V).

V_{is} is the input voltage at pins Y_n or Z , whichever is assigned as an input.

V_{os} is the output voltage at pins Z or Y_n , whichever is assigned as an output.

Symbol	Parameter	Conditions	Min	Typ	Max	Unit
I_I	input leakage current	$V_{EE} = 0\text{ V}$; $V_I = V_{CC}$ or GND				
		$V_{CC} = 6.0\text{ V}$	-	-	± 1.0	μA
		$V_{CC} = 10.0\text{ V}$	-	-	± 2.0	μA
$I_{S(OFF)}$	OFF-state leakage current	$V_{CC} = 10.0\text{ V}$; $V_{EE} = 0\text{ V}$; $V_I = V_{IH}$ or V_{IL} ; $ V_{SW} = V_{CC} - V_{EE}$; see Figure 11				
		per channel	-	-	± 1.0	μA
		all channels	-	-	± 4.0	μA
$I_{S(ON)}$	ON-state leakage current	$V_I = V_{IH}$ or V_{IL} ; $ V_{SW} = V_{CC} - V_{EE}$; $V_{CC} = 10.0\text{ V}$; $V_{EE} = 0\text{ V}$; see Figure 12	-	-	± 4.0	μA
I_{CC}	supply current	$V_{EE} = 0\text{ V}$; $V_I = V_{CC}$ or GND; $V_{is} = V_{EE}$ or V_{CC} ; $V_{os} = V_{CC}$ or V_{EE}				
		$V_{CC} = 6.0\text{ V}$	-	-	160.0	μA
		$V_{CC} = 10.0\text{ V}$	-	-	320.0	μA

Table 8. Static characteristics for 74HCT4051

Voltages are referenced to GND (ground = 0 V).

V_{is} is the input voltage at pins Y_n or Z , whichever is assigned as an input.

V_{os} is the output voltage at pins Z or Y_n , whichever is assigned as an output.

Symbol	Parameter	Conditions	Min	Typ	Max	Unit
$T_{amb} = 25\text{ }^\circ\text{C}$						
V_{IH}	HIGH-level input voltage	$V_{CC} = 4.5\text{ V}$ to 5.5 V	2.0	1.6	-	V
V_{IL}	LOW-level input voltage	$V_{CC} = 4.5\text{ V}$ to 5.5 V	-	1.2	0.8	V
I_I	input leakage current	$V_I = V_{CC}$ or GND; $V_{CC} = 5.5\text{ V}$; $V_{EE} = 0\text{ V}$	-	-	± 0.1	μA
$I_{S(OFF)}$	OFF-state leakage current	$V_{CC} = 10.0\text{ V}$; $V_{EE} = 0\text{ V}$; $V_I = V_{IH}$ or V_{IL} ; $ V_{SW} = V_{CC} - V_{EE}$; see Figure 11				
		per channel	-	-	± 0.1	μA
		all channels	-	-	± 0.4	μA
$I_{S(ON)}$	ON-state leakage current	$V_{CC} = 10.0\text{ V}$; $V_{EE} = 0\text{ V}$; $V_I = V_{IH}$ or V_{IL} ; $ V_{SW} = V_{CC} - V_{EE}$; see Figure 12	-	-	± 0.4	μA
I_{CC}	supply current	$V_I = V_{CC}$ or GND; $V_{is} = V_{EE}$ or V_{CC} ; $V_{os} = V_{CC}$ or V_{EE}				
		$V_{CC} = 5.5\text{ V}$; $V_{EE} = 0\text{ V}$	-	-	8.0	μA
		$V_{CC} = 5.0\text{ V}$; $V_{EE} = -5.0\text{ V}$	-	-	16.0	μA
ΔI_{CC}	additional supply current	per input; $V_I = V_{CC} - 2.1\text{ V}$; other inputs at V_{CC} or GND; $V_{CC} = 4.5\text{ V}$ to 5.5 V ; $V_{EE} = 0\text{ V}$	-	50	180	μA
C_I	input capacitance		-	3.5	-	pF
C_{SW}	switch capacitance	independent pins Y_n	-	5	-	pF
		common pins Z	-	25	-	pF

Table 8. Static characteristics for 74HCT4051 ...continued

Voltages are referenced to GND (ground = 0 V).

V_{is} is the input voltage at pins Y_n or Z , whichever is assigned as an input.

V_{os} is the output voltage at pins Z or Y_n , whichever is assigned as an output.

Symbol	Parameter	Conditions	Min	Typ	Max	Unit
$T_{amb} = -40\text{ °C to }+85\text{ °C}$						
V_{IH}	HIGH-level input voltage	$V_{CC} = 4.5\text{ V to }5.5\text{ V}$	2.0	-	-	V
V_{IL}	LOW-level input voltage	$V_{CC} = 4.5\text{ V to }5.5\text{ V}$	-	-	0.8	V
I_I	input leakage current	$V_I = V_{CC}$ or GND; $V_{CC} = 5.5\text{ V}$; $V_{EE} = 0\text{ V}$	-	-	± 1.0	μA
$I_{S(OFF)}$	OFF-state leakage current	$V_{CC} = 10.0\text{ V}$; $V_{EE} = 0\text{ V}$; $V_I = V_{IH}$ or V_{IL} ; $ V_{SW} = V_{CC} - V_{EE}$; see Figure 11				
		per channel	-	-	± 1.0	μA
		all channels	-	-	± 4.0	μA
$I_{S(ON)}$	ON-state leakage current	$V_{CC} = 10.0\text{ V}$; $V_{EE} = 0\text{ V}$; $V_I = V_{IH}$ or V_{IL} ; $ V_{SW} = V_{CC} - V_{EE}$; see Figure 12	-	-	± 4.0	μA
I_{CC}	supply current	$V_I = V_{CC}$ or GND; $V_{is} = V_{EE}$ or V_{CC} ; $V_{os} = V_{CC}$ or V_{EE}				
		$V_{CC} = 5.5\text{ V}$; $V_{EE} = 0\text{ V}$	-	-	80.0	μA
		$V_{CC} = 5.0\text{ V}$; $V_{EE} = -5.0\text{ V}$	-	-	160.0	μA
ΔI_{CC}	additional supply current	per input; $V_I = V_{CC} - 2.1\text{ V}$; other inputs at V_{CC} or GND; $V_{CC} = 4.5\text{ V to }5.5\text{ V}$; $V_{EE} = 0\text{ V}$	-	-	225	μA
$T_{amb} = -40\text{ °C to }+125\text{ °C}$						
V_{IH}	HIGH-level input voltage	$V_{CC} = 4.5\text{ V to }5.5\text{ V}$	2.0	-	-	V
V_{IL}	LOW-level input voltage	$V_{CC} = 4.5\text{ V to }5.5\text{ V}$	-	-	0.8	V
I_I	input leakage current	$V_I = V_{CC}$ or GND; $V_{CC} = 5.5\text{ V}$; $V_{EE} = 0\text{ V}$	-	-	± 1.0	μA
$I_{S(OFF)}$	OFF-state leakage current	$V_{CC} = 10.0\text{ V}$; $V_{EE} = 0\text{ V}$; $V_I = V_{IH}$ or V_{IL} ; $ V_{SW} = V_{CC} - V_{EE}$; see Figure 11				
		per channel	-	-	± 1.0	μA
		all channels	-	-	± 4.0	μA
$I_{S(ON)}$	ON-state leakage current	$V_{CC} = 10.0\text{ V}$; $V_{EE} = 0\text{ V}$; $V_I = V_{IH}$ or V_{IL} ; $ V_{SW} = V_{CC} - V_{EE}$; see Figure 12	-	-	± 4.0	μA
I_{CC}	supply current	$V_I = V_{CC}$ or GND; $V_{is} = V_{EE}$ or V_{CC} ; $V_{os} = V_{CC}$ or V_{EE}				
		$V_{CC} = 5.5\text{ V}$; $V_{EE} = 0\text{ V}$	-	-	160.0	μA
		$V_{CC} = 5.0\text{ V}$; $V_{EE} = -5.0\text{ V}$	-	-	320.0	μA
ΔI_{CC}	additional supply current	per input; $V_I = V_{CC} - 2.1\text{ V}$; other inputs at V_{CC} or GND; $V_{CC} = 4.5\text{ V to }5.5\text{ V}$; $V_{EE} = 0\text{ V}$	-	-	245	μA

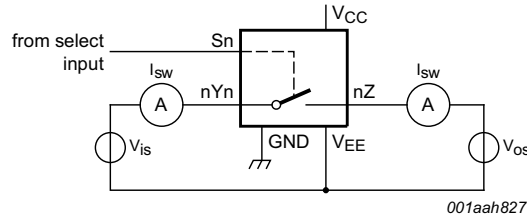

$V_{is} = V_{CC}$ and $V_{os} = V_{EE}$.
 $V_{is} = V_{EE}$ and $V_{os} = V_{CC}$.

Fig 11. Test circuit for measuring OFF-state current

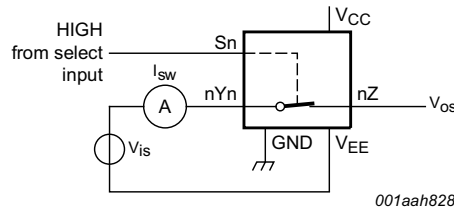

$V_{is} = V_{CC}$ and $V_{os} = \text{open-circuit}$.
 $V_{is} = V_{EE}$ and $V_{os} = \text{open-circuit}$.

Fig 12. Test circuit for measuring ON-state current

11. Dynamic characteristics

Table 9. Dynamic characteristics for 74HC4051

$GND = 0\text{ V}$; $t_r = t_f = 6\text{ ns}$; $C_L = 50\text{ pF}$; for test circuit see [Figure 15](#).

V_{is} is the input voltage at a Yn or Z terminal, whichever is assigned as an input.

V_{os} is the output voltage at a Yn or Z terminal, whichever is assigned as an output.

Symbol	Parameter	Conditions	Min	Typ	Max	Unit
$T_{amb} = 25\text{ °C}$						
t_{pd}	propagation delay	V_{is} to V_{os} ; $R_L = \infty\ \Omega$; see Figure 13	[1]			
		$V_{CC} = 2.0\text{ V}$; $V_{EE} = 0\text{ V}$	-	14	60	ns
		$V_{CC} = 4.5\text{ V}$; $V_{EE} = 0\text{ V}$	-	5	12	ns
		$V_{CC} = 6.0\text{ V}$; $V_{EE} = 0\text{ V}$	-	4	10	ns
		$V_{CC} = 4.5\text{ V}$; $V_{EE} = -4.5\text{ V}$	-	4	8	ns

Table 9. Dynamic characteristics for 74HC4051 ...continued

$GND = 0\text{ V}$; $t_r = t_f = 6\text{ ns}$; $C_L = 50\text{ pF}$; for test circuit see [Figure 15](#).

V_{is} is the input voltage at a Yn or Z terminal, whichever is assigned as an input.

V_{os} is the output voltage at a Yn or Z terminal, whichever is assigned as an output.

Symbol	Parameter	Conditions	Min	Typ	Max	Unit	
t_{on}	turn-on time	\bar{E} to V_{os} ; $R_L = \infty\ \Omega$; see Figure 14 [2]					
		$V_{CC} = 2.0\text{ V}$; $V_{EE} = 0\text{ V}$	-	72	345	ns	
		$V_{CC} = 4.5\text{ V}$; $V_{EE} = 0\text{ V}$	-	29	69	ns	
		$V_{CC} = 5.0\text{ V}$; $V_{EE} = 0\text{ V}$; $C_L = 15\text{ pF}$	-	22	-	ns	
		$V_{CC} = 6.0\text{ V}$; $V_{EE} = 0\text{ V}$	-	21	59	ns	
		$V_{CC} = 4.5\text{ V}$; $V_{EE} = -4.5\text{ V}$	-	18	51	ns	
		Sn to V_{os} ; $R_L = \infty\ \Omega$; see Figure 14 [2]					
		$V_{CC} = 2.0\text{ V}$; $V_{EE} = 0\text{ V}$	-	66	345	ns	
		$V_{CC} = 4.5\text{ V}$; $V_{EE} = 0\text{ V}$	-	28	69	ns	
		$V_{CC} = 5.0\text{ V}$; $V_{EE} = 0\text{ V}$; $C_L = 15\text{ pF}$	-	20	-	ns	
		$V_{CC} = 6.0\text{ V}$; $V_{EE} = 0\text{ V}$	-	19	59	ns	
		$V_{CC} = 4.5\text{ V}$; $V_{EE} = -4.5\text{ V}$	-	16	51	ns	
t_{off}	turn-off time	\bar{E} to V_{os} ; $R_L = 1\text{ k}\Omega$; see Figure 14 [3]					
		$V_{CC} = 2.0\text{ V}$; $V_{EE} = 0\text{ V}$	-	58	290	ns	
		$V_{CC} = 4.5\text{ V}$; $V_{EE} = 0\text{ V}$	-	31	58	ns	
		$V_{CC} = 5.0\text{ V}$; $V_{EE} = 0\text{ V}$; $C_L = 15\text{ pF}$	-	18	-	ns	
		$V_{CC} = 6.0\text{ V}$; $V_{EE} = 0\text{ V}$	-	17	49	ns	
		$V_{CC} = 4.5\text{ V}$; $V_{EE} = -4.5\text{ V}$	-	18	42	ns	
		Sn to V_{os} ; $R_L = 1\text{ k}\Omega$; see Figure 14 [3]					
		$V_{CC} = 2.0\text{ V}$; $V_{EE} = 0\text{ V}$	-	61	290	ns	
		$V_{CC} = 4.5\text{ V}$; $V_{EE} = 0\text{ V}$	-	25	58	ns	
		$V_{CC} = 5.0\text{ V}$; $V_{EE} = 0\text{ V}$; $C_L = 15\text{ pF}$	-	19	-	ns	
		$V_{CC} = 6.0\text{ V}$; $V_{EE} = 0\text{ V}$	-	18	49	ns	
		$V_{CC} = 4.5\text{ V}$; $V_{EE} = -4.5\text{ V}$	-	18	42	ns	
C_{PD}	power dissipation capacitance	per switch; $V_I = GND$ to V_{CC} [4]	-	25	-	pF	
$T_{amb} = -40\text{ }^\circ\text{C to }+85\text{ }^\circ\text{C}$							
t_{pd}	propagation delay	V_{is} to V_{os} ; $R_L = \infty\ \Omega$; see Figure 13 [1]					
		$V_{CC} = 2.0\text{ V}$; $V_{EE} = 0\text{ V}$	-	-	75	ns	
		$V_{CC} = 4.5\text{ V}$; $V_{EE} = 0\text{ V}$	-	-	15	ns	
		$V_{CC} = 6.0\text{ V}$; $V_{EE} = 0\text{ V}$	-	-	13	ns	
		$V_{CC} = 4.5\text{ V}$; $V_{EE} = -4.5\text{ V}$	-	-	10	ns	

Table 9. Dynamic characteristics for 74HC4051 ...continued

$GND = 0\text{ V}$; $t_r = t_f = 6\text{ ns}$; $C_L = 50\text{ pF}$; for test circuit see [Figure 15](#).

V_{is} is the input voltage at a Yn or Z terminal, whichever is assigned as an input.

V_{os} is the output voltage at a Yn or Z terminal, whichever is assigned as an output.

Symbol	Parameter	Conditions	Min	Typ	Max	Unit
t_{on}	turn-on time	\bar{E} to V_{os} ; $R_L = \infty\ \Omega$; see Figure 14 ^[2]				
		$V_{CC} = 2.0\text{ V}$; $V_{EE} = 0\text{ V}$	-	-	430	ns
		$V_{CC} = 4.5\text{ V}$; $V_{EE} = 0\text{ V}$	-	-	86	ns
		$V_{CC} = 6.0\text{ V}$; $V_{EE} = 0\text{ V}$	-	-	73	ns
		$V_{CC} = 4.5\text{ V}$; $V_{EE} = -4.5\text{ V}$	-	-	64	ns
		Sn to V_{os} ; $R_L = \infty\ \Omega$; see Figure 14 ^[2]				
		$V_{CC} = 2.0\text{ V}$; $V_{EE} = 0\text{ V}$	-	-	430	ns
		$V_{CC} = 4.5\text{ V}$; $V_{EE} = 0\text{ V}$	-	-	86	ns
		$V_{CC} = 6.0\text{ V}$; $V_{EE} = 0\text{ V}$	-	-	73	ns
		$V_{CC} = 4.5\text{ V}$; $V_{EE} = -4.5\text{ V}$	-	-	64	ns
t_{off}	turn-off time	\bar{E} to V_{os} ; $R_L = 1\text{ k}\Omega$; see Figure 14 ^[3]				
		$V_{CC} = 2.0\text{ V}$; $V_{EE} = 0\text{ V}$	-	-	365	ns
		$V_{CC} = 4.5\text{ V}$; $V_{EE} = 0\text{ V}$	-	-	73	ns
		$V_{CC} = 6.0\text{ V}$; $V_{EE} = 0\text{ V}$	-	-	62	ns
		$V_{CC} = 4.5\text{ V}$; $V_{EE} = -4.5\text{ V}$	-	-	53	ns
		Sn to V_{os} ; $R_L = 1\text{ k}\Omega$; see Figure 14 ^[3]				
		$V_{CC} = 2.0\text{ V}$; $V_{EE} = 0\text{ V}$	-	-	365	ns
		$V_{CC} = 4.5\text{ V}$; $V_{EE} = 0\text{ V}$	-	-	73	ns
		$V_{CC} = 6.0\text{ V}$; $V_{EE} = 0\text{ V}$	-	-	62	ns
		$V_{CC} = 4.5\text{ V}$; $V_{EE} = -4.5\text{ V}$	-	-	53	ns
$T_{amb} = -40\text{ }^\circ\text{C to }+125\text{ }^\circ\text{C}$						
t_{pd}	propagation delay	V_{is} to V_{os} ; $R_L = \infty\ \Omega$; see Figure 13 ^[1]				
		$V_{CC} = 2.0\text{ V}$; $V_{EE} = 0\text{ V}$	-	-	90	ns
		$V_{CC} = 4.5\text{ V}$; $V_{EE} = 0\text{ V}$	-	-	18	ns
		$V_{CC} = 6.0\text{ V}$; $V_{EE} = 0\text{ V}$	-	-	15	ns
		$V_{CC} = 4.5\text{ V}$; $V_{EE} = -4.5\text{ V}$	-	-	12	ns
t_{on}	turn-on time	\bar{E} to V_{os} ; $R_L = \infty\ \Omega$; see Figure 14 ^[2]				
		$V_{CC} = 2.0\text{ V}$; $V_{EE} = 0\text{ V}$	-	-	520	ns
		$V_{CC} = 4.5\text{ V}$; $V_{EE} = 0\text{ V}$	-	-	104	ns
		$V_{CC} = 6.0\text{ V}$; $V_{EE} = 0\text{ V}$	-	-	88	ns
		$V_{CC} = 4.5\text{ V}$; $V_{EE} = -4.5\text{ V}$	-	-	77	ns
		Sn to V_{os} ; $R_L = \infty\ \Omega$; see Figure 14 ^[2]				
		$V_{CC} = 2.0\text{ V}$; $V_{EE} = 0\text{ V}$	-	-	520	ns
		$V_{CC} = 4.5\text{ V}$; $V_{EE} = 0\text{ V}$	-	-	104	ns
		$V_{CC} = 6.0\text{ V}$; $V_{EE} = 0\text{ V}$	-	-	88	ns
$V_{CC} = 4.5\text{ V}$; $V_{EE} = -4.5\text{ V}$	-	-	77	ns		

Table 9. Dynamic characteristics for 74HC4051 ...continued

$GND = 0\text{ V}$; $t_r = t_f = 6\text{ ns}$; $C_L = 50\text{ pF}$; for test circuit see [Figure 15](#).

V_{is} is the input voltage at a Yn or Z terminal, whichever is assigned as an input.

V_{os} is the output voltage at a Yn or Z terminal, whichever is assigned as an output.

Symbol	Parameter	Conditions	Min	Typ	Max	Unit
t_{off}	turn-off time	\bar{E} to V_{os} ; $R_L = 1\text{ k}\Omega$; see Figure 14 ^[3]				
		$V_{CC} = 2.0\text{ V}$; $V_{EE} = 0\text{ V}$	-	-	435	ns
		$V_{CC} = 4.5\text{ V}$; $V_{EE} = 0\text{ V}$	-	-	87	ns
		$V_{CC} = 6.0\text{ V}$; $V_{EE} = 0\text{ V}$	-	-	74	ns
		$V_{CC} = 4.5\text{ V}$; $V_{EE} = -4.5\text{ V}$	-	-	72	ns
		Sn to V_{os} ; $R_L = 1\text{ k}\Omega$; see Figure 14 ^[3]				
		$V_{CC} = 2.0\text{ V}$; $V_{EE} = 0\text{ V}$	-	-	435	ns
		$V_{CC} = 4.5\text{ V}$; $V_{EE} = 0\text{ V}$	-	-	87	ns
$V_{CC} = 6.0\text{ V}$; $V_{EE} = 0\text{ V}$	-	-	74	ns		
$V_{CC} = 4.5\text{ V}$; $V_{EE} = -4.5\text{ V}$	-	-	72	ns		

[1] t_{pd} is the same as t_{PHL} and t_{PLH} .

[2] t_{on} is the same as t_{PZH} and t_{PZL} .

[3] t_{off} is the same as t_{PHZ} and t_{PLZ} .

[4] C_{PD} is used to determine the dynamic power dissipation (P_D in μW).

$P_D = C_{PD} \times V_{CC}^2 \times f_i \times N + \Sigma\{(C_L + C_{sw}) \times V_{CC}^2 \times f_o\}$ where:

f_i = input frequency in MHz;

f_o = output frequency in MHz;

N = number of inputs switching;

$\Sigma\{(C_L + C_{sw}) \times V_{CC}^2 \times f_o\}$ = sum of outputs;

C_L = output load capacitance in pF;

C_{sw} = switch capacitance in pF;

V_{CC} = supply voltage in V.

Table 10. Dynamic characteristics for 74HCT4051

$GND = 0\text{ V}$; $t_r = t_f = 6\text{ ns}$; $C_L = 50\text{ pF}$; for test circuit see [Figure 15](#).

V_{is} is the input voltage at a Yn or Z terminal, whichever is assigned as an input.

V_{os} is the output voltage at a Yn or Z terminal, whichever is assigned as an output.

Symbol	Parameter	Conditions	Min	Typ	Max	Unit
$T_{amb} = 25\text{ }^\circ\text{C}$						
t_{pd}	propagation delay	V_{is} to V_{os} ; $R_L = \infty\ \Omega$; see Figure 13 ^[1]				
		$V_{CC} = 4.5\text{ V}$; $V_{EE} = 0\text{ V}$	-	5	12	ns
		$V_{CC} = 4.5\text{ V}$; $V_{EE} = -4.5\text{ V}$	-	4	8	ns
t_{on}	turn-on time	\bar{E} to V_{os} ; $R_L = 1\text{ k}\Omega$; see Figure 14 ^[2]				
		$V_{CC} = 4.5\text{ V}$; $V_{EE} = 0\text{ V}$	-	26	55	ns
		$V_{CC} = 5.0\text{ V}$; $V_{EE} = 0\text{ V}$; $C_L = 15\text{ pF}$	-	22	-	ns
		$V_{CC} = 4.5\text{ V}$; $V_{EE} = -4.5\text{ V}$	-	16	39	ns
		Sn to V_{os} ; $R_L = 1\text{ k}\Omega$; see Figure 14 ^[2]				
		$V_{CC} = 4.5\text{ V}$; $V_{EE} = 0\text{ V}$	-	28	55	ns
		$V_{CC} = 5.0\text{ V}$; $V_{EE} = 0\text{ V}$; $C_L = 15\text{ pF}$	-	24	-	ns
$V_{CC} = 4.5\text{ V}$; $V_{EE} = -4.5\text{ V}$	-	16	39	ns		

Table 10. Dynamic characteristics for 74HCT4051 ...continued

$GND = 0\text{ V}$; $t_r = t_f = 6\text{ ns}$; $C_L = 50\text{ pF}$; for test circuit see [Figure 15](#).

V_{is} is the input voltage at a Yn or Z terminal, whichever is assigned as an input.

V_{os} is the output voltage at a Yn or Z terminal, whichever is assigned as an output.

Symbol	Parameter	Conditions	Min	Typ	Max	Unit	
t_{off}	turn-off time	\bar{E} to V_{os} ; $R_L = 1\text{ k}\Omega$; see Figure 14 [3]					
		$V_{CC} = 4.5\text{ V}$; $V_{EE} = 0\text{ V}$	-	19	45	ns	
		$V_{CC} = 5.0\text{ V}$; $V_{EE} = 0\text{ V}$; $C_L = 15\text{ pF}$	-	16	-	ns	
		$V_{CC} = 4.5\text{ V}$; $V_{EE} = -4.5\text{ V}$	-	16	32	ns	
		Sn to V_{os} ; $R_L = 1\text{ k}\Omega$; see Figure 14 [3]					
		$V_{CC} = 4.5\text{ V}$; $V_{EE} = 0\text{ V}$	-	23	45	ns	
		$V_{CC} = 5.0\text{ V}$; $V_{EE} = 0\text{ V}$; $C_L = 15\text{ pF}$	-	20	-	ns	
C_{PD}	power dissipation capacitance	per switch; $V_I = GND$ to $V_{CC} - 1.5\text{ V}$ [4]	-	25	-	pF	
		$T_{amb} = -40\text{ }^\circ\text{C to }+85\text{ }^\circ\text{C}$					
		t_{pd}	propagation delay	V_{is} to V_{os} ; $R_L = \infty\ \Omega$; see Figure 13 [1]			
$V_{CC} = 4.5\text{ V}$; $V_{EE} = 0\text{ V}$	-			-	15	ns	
$V_{CC} = 4.5\text{ V}$; $V_{EE} = -4.5\text{ V}$	-			-	10	ns	
t_{on}	turn-on time	\bar{E} to V_{os} ; $R_L = 1\text{ k}\Omega$; see Figure 14 [2]					
		$V_{CC} = 4.5\text{ V}$; $V_{EE} = 0\text{ V}$	-	-	69	ns	
		$V_{CC} = 4.5\text{ V}$; $V_{EE} = -4.5\text{ V}$	-	-	49	ns	
		Sn to V_{os} ; $R_L = 1\text{ k}\Omega$; see Figure 14 [2]					
		$V_{CC} = 4.5\text{ V}$; $V_{EE} = 0\text{ V}$	-	-	69	ns	
		$V_{CC} = 4.5\text{ V}$; $V_{EE} = -4.5\text{ V}$	-	-	49	ns	
t_{off}	turn-off time	\bar{E} to V_{os} ; $R_L = 1\text{ k}\Omega$; see Figure 14 [3]					
		$V_{CC} = 4.5\text{ V}$; $V_{EE} = 0\text{ V}$	-	-	56	ns	
		$V_{CC} = 4.5\text{ V}$; $V_{EE} = -4.5\text{ V}$	-	-	40	ns	
		Sn to V_{os} ; $R_L = 1\text{ k}\Omega$; see Figure 14 [3]					
		$V_{CC} = 4.5\text{ V}$; $V_{EE} = 0\text{ V}$	-	-	56	ns	
		$V_{CC} = 4.5\text{ V}$; $V_{EE} = -4.5\text{ V}$	-	-	40	ns	
$T_{amb} = -40\text{ }^\circ\text{C to }+125\text{ }^\circ\text{C}$							
t_{pd}	propagation delay	V_{is} to V_{os} ; $R_L = \infty\ \Omega$; see Figure 13 [1]					
		$V_{CC} = 4.5\text{ V}$; $V_{EE} = 0\text{ V}$	-	-	18	ns	
		$V_{CC} = 4.5\text{ V}$; $V_{EE} = -4.5\text{ V}$	-	-	12	ns	
t_{on}	turn-on time	\bar{E} to V_{os} ; $R_L = 1\text{ k}\Omega$; see Figure 14 [2]					
		$V_{CC} = 4.5\text{ V}$; $V_{EE} = 0\text{ V}$	-	-	83	ns	
		$V_{CC} = 4.5\text{ V}$; $V_{EE} = -4.5\text{ V}$	-	-	59	ns	
		Sn to V_{os} ; $R_L = 1\text{ k}\Omega$; see Figure 14 [2]					
		$V_{CC} = 4.5\text{ V}$; $V_{EE} = 0\text{ V}$	-	-	83	ns	
		$V_{CC} = 4.5\text{ V}$; $V_{EE} = -4.5\text{ V}$	-	-	59	ns	

Table 10. Dynamic characteristics for 74HCT4051 ...continued

$GND = 0\text{ V}$; $t_r = t_f = 6\text{ ns}$; $C_L = 50\text{ pF}$; for test circuit see [Figure 15](#).

V_{is} is the input voltage at a Y_n or Z terminal, whichever is assigned as an input.

V_{os} is the output voltage at a Y_n or Z terminal, whichever is assigned as an output.

Symbol	Parameter	Conditions	Min	Typ	Max	Unit
t_{off}	turn-off time	\bar{E} to V_{os} ; $R_L = 1\text{ k}\Omega$; see Figure 14 [3]				
		$V_{CC} = 4.5\text{ V}$; $V_{EE} = 0\text{ V}$	-	-	68	ns
		$V_{CC} = 4.5\text{ V}$; $V_{EE} = -4.5\text{ V}$	-	-	48	ns
		S_n to V_{os} ; $R_L = 1\text{ k}\Omega$; see Figure 14 [3]				
		$V_{CC} = 4.5\text{ V}$; $V_{EE} = 0\text{ V}$	-	-	68	ns
		$V_{CC} = 4.5\text{ V}$; $V_{EE} = -4.5\text{ V}$	-	-	48	ns

[1] t_{pd} is the same as t_{PHL} and t_{PLH} .

[2] t_{on} is the same as t_{PZH} and t_{PZL} .

[3] t_{off} is the same as t_{PHZ} and t_{PLZ} .

[4] C_{PD} is used to determine the dynamic power dissipation (P_D in μW).

$$P_D = C_{PD} \times V_{CC}^2 \times f_i \times N + \Sigma\{(C_L + C_{sw}) \times V_{CC}^2 \times f_o\}$$
 where:

f_i = input frequency in MHz;

f_o = output frequency in MHz;

N = number of inputs switching;

$\Sigma\{(C_L + C_{sw}) \times V_{CC}^2 \times f_o\}$ = sum of outputs;

C_L = output load capacitance in pF;

C_{sw} = switch capacitance in pF;

V_{CC} = supply voltage in V.

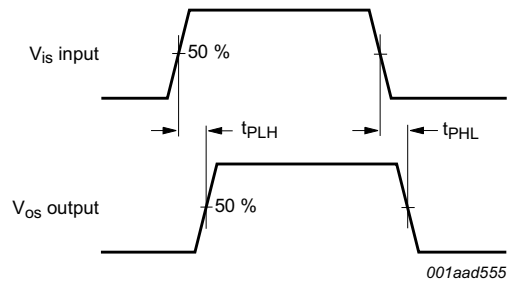
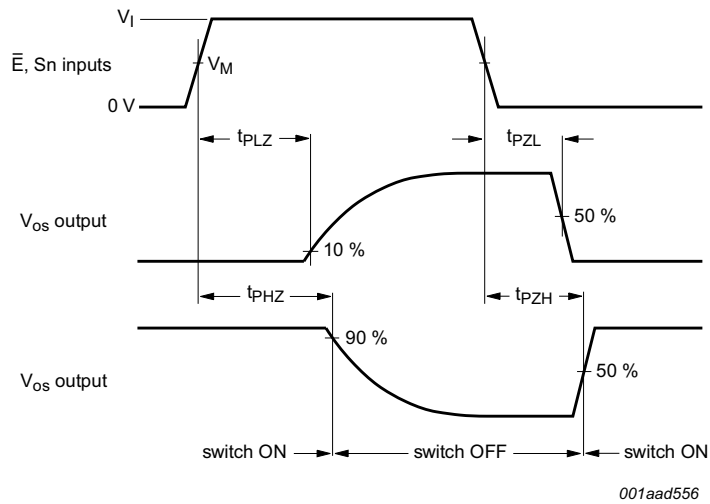
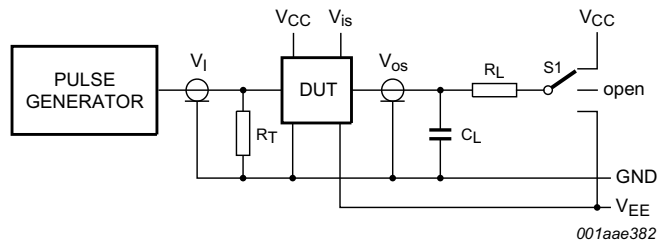
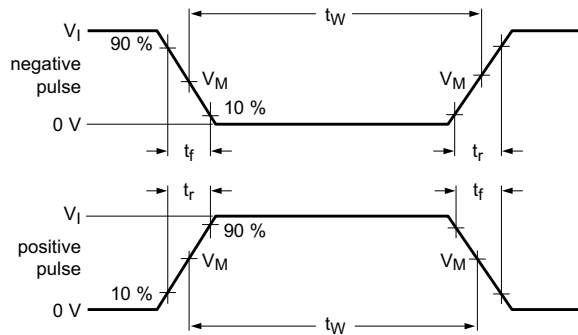

Fig 13. Input (V_{is}) to output (V_{os}) propagation delays



For 74HC4051: $V_M = 0.5 \times V_{CC}$.
 For 74HCT4051: $V_M = 1.3 \text{ V}$.

Fig 14. Turn-on and turn-off times



Definitions for test circuit; see [Table 11](#):

R_T = termination resistance should be equal to the output impedance Z_o of the pulse generator.

C_L = load capacitance including jig and probe capacitance.

R_L = load resistance.

S1 = Test selection switch.

Fig 15. Test circuit for measuring AC performance

Table 11. Test data

Test	Input				Load		S1 position
	V_I	V_{is}	t_r, t_f		C_L	R_L	
			at f_{max}	other ^[1]			
t_{PHL}, t_{PLH}	[2]	pulse	< 2 ns	6 ns	50 pF	1 k Ω	open
t_{PZH}, t_{PHZ}	[2]	V_{CC}	< 2 ns	6 ns	50 pF	1 k Ω	V_{EE}
t_{PZL}, t_{PLZ}	[2]	V_{EE}	< 2 ns	6 ns	50 pF	1 k Ω	V_{CC}

[1] $t_r = t_f = 6$ ns; when measuring f_{max} , there is no constraint to t_r and t_f with 50 % duty factor.

[2] V_I values:

- a) For 74HC4051: $V_I = V_{CC}$
- b) For 74HCT4051: $V_I = 3$ V

11.1 Additional dynamic characteristics

Table 12. Additional dynamic characteristics

Recommended conditions and typical values; GND = 0 V; T_{amb} = 25 °C; C_L = 50 pF.

V_{is} is the input voltage at pins nYn or nZ, whichever is assigned as an input.

V_{os} is the output voltage at pins nYn or nZ, whichever is assigned as an output.

Symbol	Parameter	Conditions	Min	Typ	Max	Unit	
d _{sin}	sine-wave distortion	f _i = 1 kHz; R _L = 10 kΩ; see Figure 16					
		V _{is} = 4.0 V (p-p); V _{CC} = 2.25 V; V _{EE} = -2.25 V	-	0.04	-	%	
		V _{is} = 8.0 V (p-p); V _{CC} = 4.5 V; V _{EE} = -4.5 V	-	0.02	-	%	
		f _i = 10 kHz; R _L = 10 kΩ; see Figure 16					
		V _{is} = 4.0 V (p-p); V _{CC} = 2.25 V; V _{EE} = -2.25 V	-	0.12	-	%	
		V _{is} = 8.0 V (p-p); V _{CC} = 4.5 V; V _{EE} = -4.5 V	-	0.06	-	%	
α _{iso}	isolation (OFF-state)	R _L = 600 Ω; f _i = 1 MHz; see Figure 17					
		V _{CC} = 2.25 V; V _{EE} = -2.25 V	[1]	-50	-	dB	
		V _{CC} = 4.5 V; V _{EE} = -4.5 V	[1]	-50	-	dB	
V _{ct}	crosstalk voltage	peak-to-peak value; between control and any switch; R _L = 600 Ω; f _i = 1 MHz; \bar{E} or Sn square wave between V _{CC} and GND; t _r = t _f = 6 ns; see Figure 18					
		V _{CC} = 4.5 V; V _{EE} = 0 V	-	110	-	mV	
		V _{CC} = 4.5 V; V _{EE} = -4.5 V	-	220	-	mV	
f _(-3dB)	-3 dB frequency response	R _L = 50 Ω; see Figure 19					
		V _{CC} = 2.25 V; V _{EE} = -2.25 V	[2]	-	170	-	MHz
		V _{CC} = 4.5 V; V _{EE} = -4.5 V	[2]	-	180	-	MHz

[1] Adjust input voltage V_{is} to 0 dBm level (0 dBm = 1 mW into 600 Ω).

[2] Adjust input voltage V_{is} to 0 dBm level at V_{os} for 1 MHz (0 dBm = 1 mW into 50 Ω).

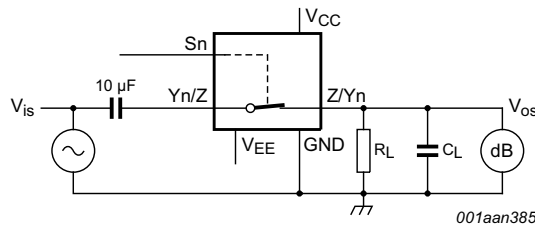
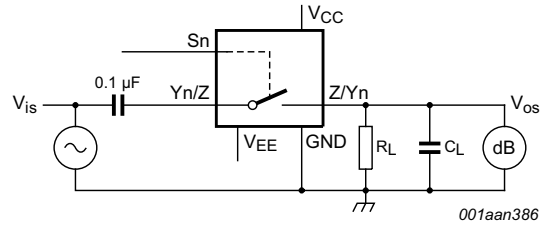
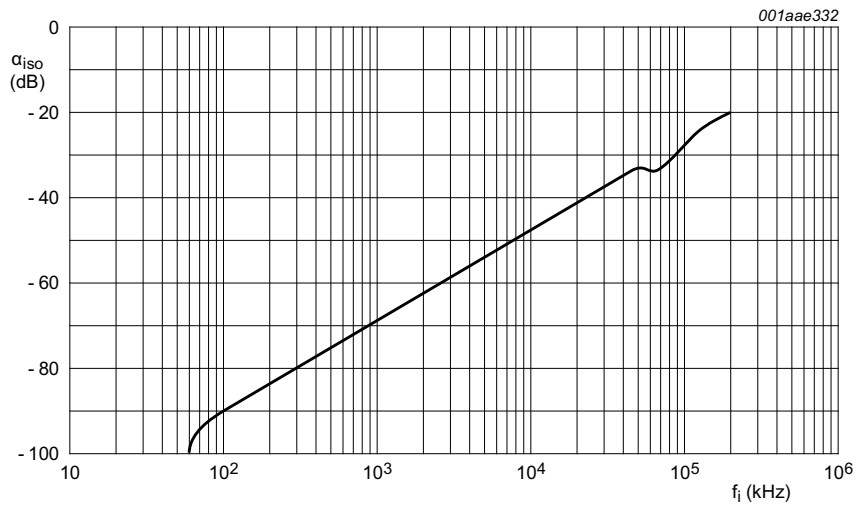

Fig 16. Test circuit for measuring sine-wave distortion



$V_{CC} = 4.5\text{ V}$; $GND = 0\text{ V}$; $V_{EE} = -4.5\text{ V}$; $R_L = 600\ \Omega$; $R_S = 1\text{ k}\Omega$.

a. Test circuit



b. Isolation (OFF-state) as a function of frequency

Fig 17. Test circuit for measuring isolation (OFF-state)

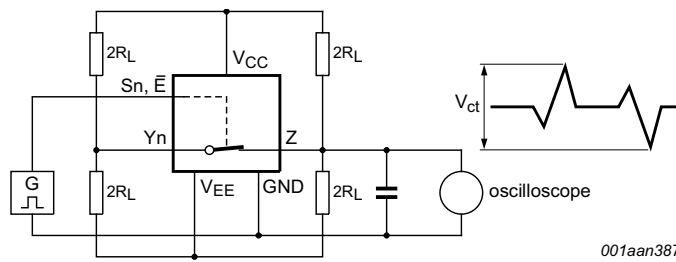
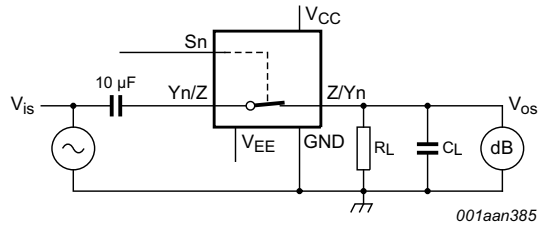
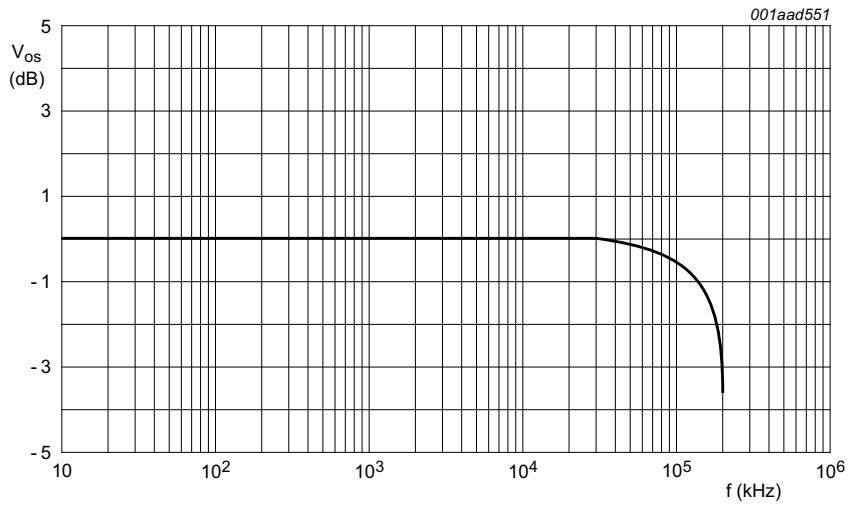

Fig 18. Test circuit for measuring crosstalk between control input and any switch



$V_{CC} = 4.5 \text{ V}$; $GND = 0 \text{ V}$; $V_{EE} = -4.5 \text{ V}$; $R_L = 50 \text{ } \Omega$; $R_S = 1 \text{ k}\Omega$.

a. Test circuit



b. Typical frequency response

Fig 19. Test circuit for frequency response

12. Package outline

SO16: plastic small outline package; 16 leads; body width 3.9 mm

SOT109-1

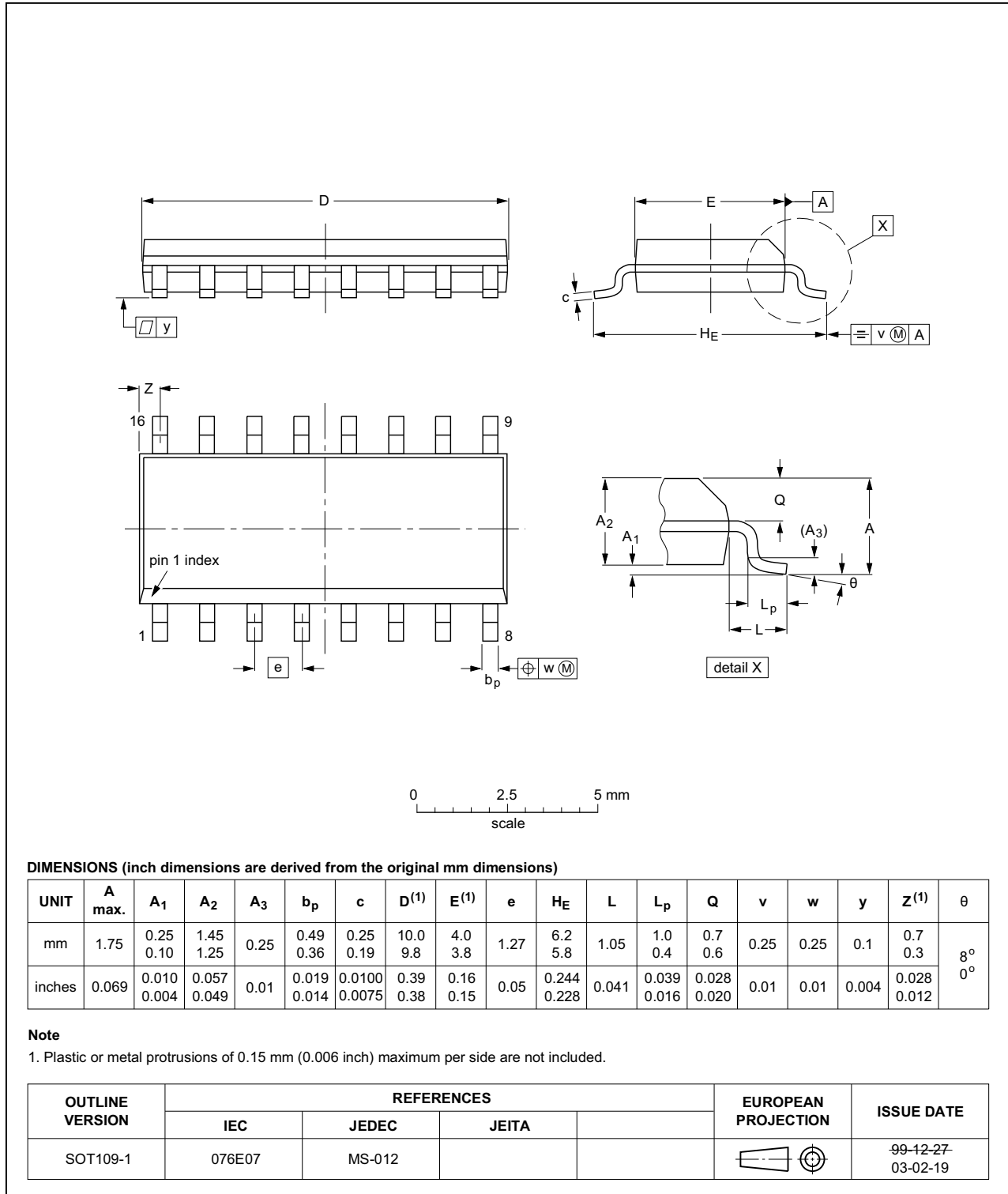

Fig 20. Package outline SOT109-1 (SO16)

SSOP16: plastic shrink small outline package; 16 leads; body width 5.3 mm

SOT338-1

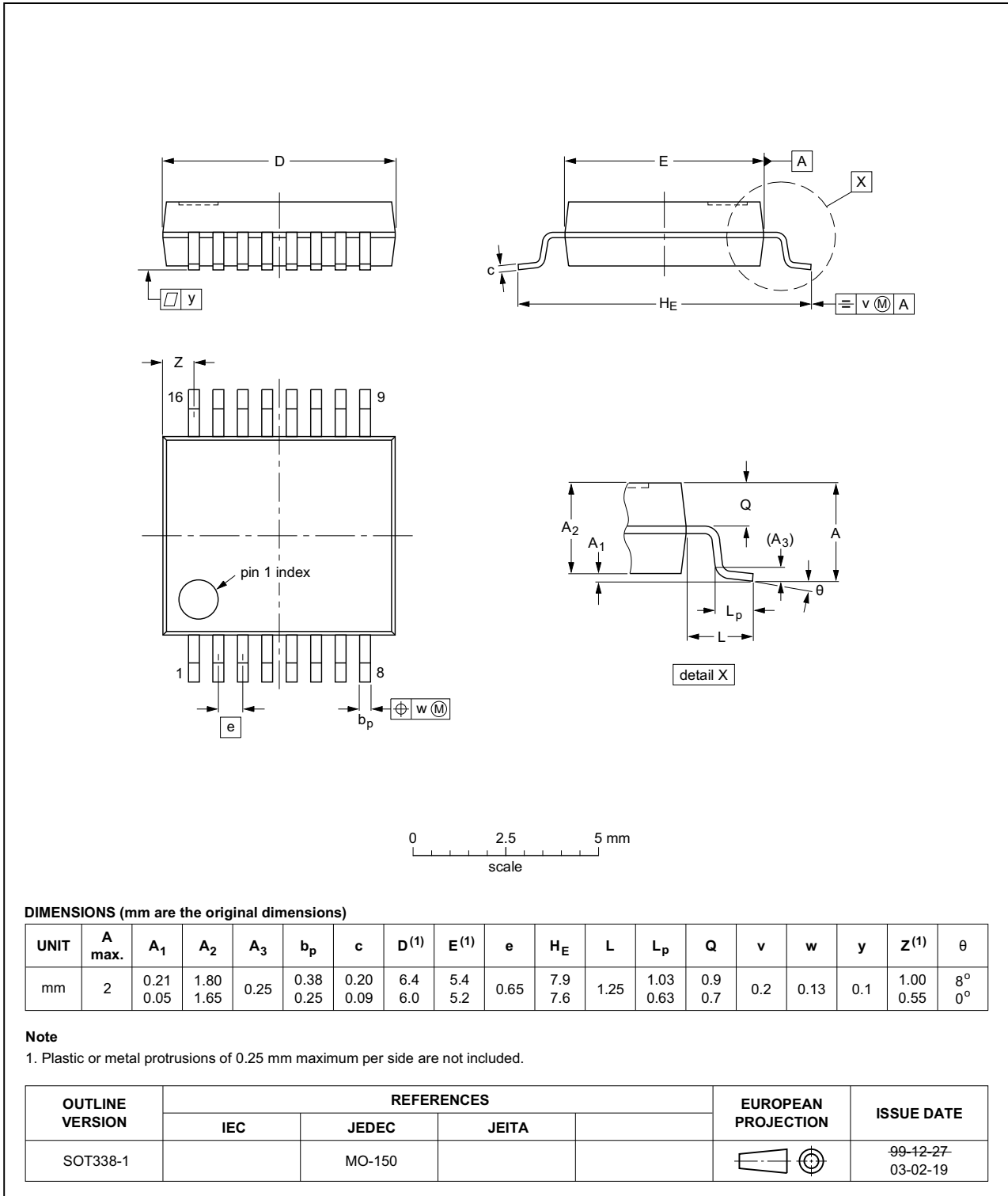

Fig 21. Package outline SOT338-1 (SSOP16)