



Chipsmall Limited consists of a professional team with an average of over 10 year of expertise in the distribution of electronic components. Based in Hongkong, we have already established firm and mutual-benefit business relationships with customers from,Europe,America and south Asia,supplying obsolete and hard-to-find components to meet their specific needs.

With the principle of "Quality Parts,Customers Priority,Honest Operation,and Considerate Service",our business mainly focus on the distribution of electronic components. Line cards we deal with include Microchip,ALPS,ROHM,Xilinx,Pulse,ON,Everlight and Freescale. Main products comprise IC,Modules,Potentiometer,IC Socket,Relay,Connector.Our parts cover such applications as commercial,industrial, and automotives areas.

We are looking forward to setting up business relationship with you and hope to provide you with the best service and solution. Let us make a better world for our industry!



Contact us

Tel: +86-755-8981 8866 Fax: +86-755-8427 6832

Email & Skype: info@chipsmall.com Web: www.chipsmall.com

Address: A1208, Overseas Decoration Building, #122 Zhenhua RD., Futian, Shenzhen, China



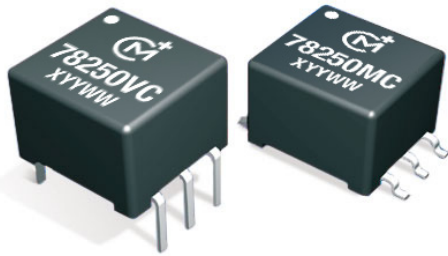

FEATURES

- RoHS compliant
- Maxim MAX250/MAX251 compatible
- Isolation to 4kVrms
- Industry-standard pinout
- Surface mount option
- UL 94 V-0 package materials
- Low profile
- Toroidal construction
- Fully encapsulated
- Industrial temperature range

DESCRIPTION

The 78250 series of converter transformers are specifically designed for use with Maxim chipsets to provide isolated RS232 interfaces. Carefully controlled turns ratios ensure consistent performance whilst a toroidal construction minimises EMI.

Surface-mount parts

The surface-mount (M suffix) products are not recommended for new designs. For existing designs, however, Murata Power Solutions will continue to manufacture and fully support these parts.

For recommended alternatives please refer to the 78250J Series datasheet.



CHARACTERISTICS 78250C/78250MC

Parameter	Conditions	Min.	Typ.	Max.	Units
Primary Inductance, L_p	10kHz, 100mV	1.0	2.0	2.5	mH
Leakage Inductance, L_L	100kHz, 100mV		2.0	3.0	μ H
Interwinding Capacitance, C_{ww}	100kHz, 100mV		69	90	pF
Primary D.C. Resistance, R_{dc}	<0.1VDC		1.0	2.0	Ω
Volt-time Product, Et	Pins1/2 or 2/3	50			V μ s

CHARACTERISTICS 78250VC/78250MVC

Parameter	Conditions	Min.	Typ.	Max.	Units
Primary Inductance, L_p	10kHz, 100mV	1.0	2.0	2.5	mH
Leakage Inductance, L_L	100kHz, 100mV		35	40	μ H
Interwinding Capacitance, C_{ww}	100kHz, 100mV		9	12	pF
Primary D.C. Resistance, R_{dc}	<0.1VDC		1.4	1.8	Ω
Volt-time Product, Et	Pins1/2 or 2/3	50			V μ s

ORDER CODE DETAILS

Order Code	Package Type	Packaging Type	Quantity
78250C / 78250VC	6 Pin DIL	Tube	50
78250MC / 78250MVC	6 Pin SM	Tube	50
78250MC-R / 78250MVC-R	6 Pin SM	Tape & Reel	500

ABSOLUTE MAXIMUM RATINGS

Operating free air temperature range	-40°C to 85°C
Storage temperature range	-50°C to 125°C
Lead temperature 1.5mm from case for 10 seconds	300°C
Peak current, I_{pk}	300mA
Isolation voltage 78250(M)C (flash tested for 1 second)	1.5kVrms
Isolation voltage 78250(M)VC (flash tested for 1 second)	4.0kVrms

All specifications typical at $T_A = 25^\circ\text{C}$

TECHNICAL NOTES

ISOLATION VOLTAGE

'Hi Pot Test', 'Flash Tested', 'Withstand Voltage', 'Proof Voltage', 'Dielectric Withstand Voltage' & 'Isolation Test Voltage' are all terms that relate to the same thing, a test voltage, applied for a specified time, across a component designed to provide electrical isolation, to verify the integrity of that isolation.

All products in this series are 100% production tested at their stated isolation voltage.

A question commonly asked is, "What is the continuous voltage that can be applied across the part in normal operation?"

For a part holding no specific agency approvals both input and output should normally be maintained within SELV limits i.e. less than 42.4V peak, or 60VDC. The isolation test voltage represents a measure of immunity to transient voltages and the part should never be used as an element of a safety isolation system. The part could be expected to function correctly with several hundred volts offset applied continuously across the isolation barrier; but then the circuitry on both sides of the barrier must be regarded as operating at an unsafe voltage and further isolation/insulation systems must form a barrier between these circuits and any user-accessible circuitry according to safety standard requirements.

REPEATED HIGH-VOLTAGE ISOLATION TESTING

It is well known that repeated high-voltage isolation testing of a barrier component can actually degrade isolation capability, to a lesser or greater degree depending on materials, construction and environment. This series has toroidal isolation transformers, with no additional insulation between primary and secondary windings of enameled wire. While parts can be expected to withstand several times the stated test voltage, the isolation capability does depend on the wire insulation. Any material, including this enamel (typically polyurethane) is susceptible to eventual chemical degradation when subject to very high applied voltages thus implying that the number of tests should be strictly limited. We therefore strongly advise against repeated high voltage isolation testing, but if it is absolutely required, that the voltage be reduced by 20% from specified test voltage.

This consideration equally applies to agency recognized parts rated for better than functional isolation where the wire enamel insulation is always supplemented by a further insulation system of physical spacing or barriers.

PACKAGE SPECIFICATIONS

MECHANICAL DIMENSIONS

6 Pin DIL

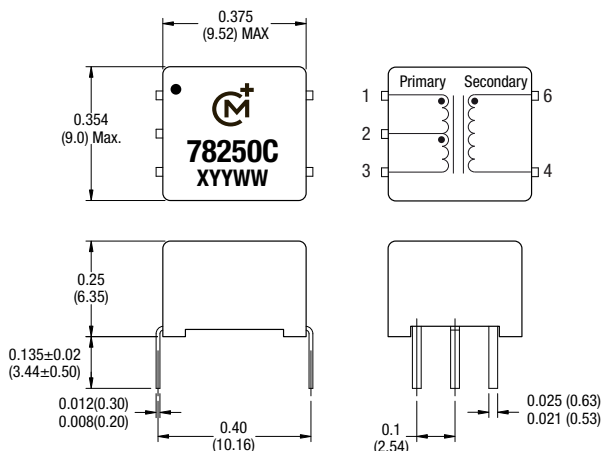

6 Pin SM

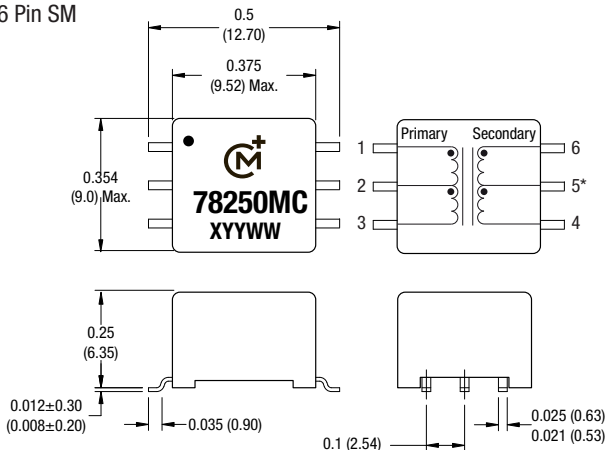

Unless otherwise stated all dimensions in inches (mm) ± 0.01 (0.25).
All pins on a 0.1 (2.54) pitch and within ± 0.01 (0.25) of true position.
* Pin 5 is connected to secondary center tap. Package Weight 1.0g TYP.

RECOMMENDED FOOTPRINT DETAILS

6 Pin DIL

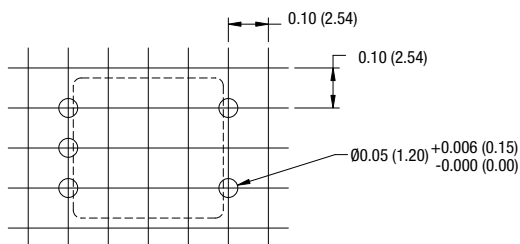

6 Pin SM

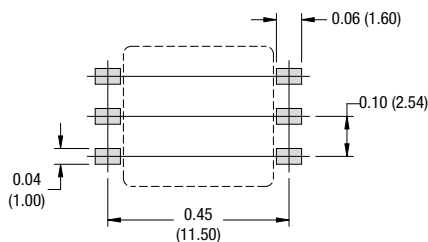

Unless otherwise stated all dimensions in inches (mm) ± 0.01 (0.25). All pins on a 0.1 (2.54) pitch and within ± 0.01 (0.25) of true position.

TUBE OUTLINE DIMENSIONS

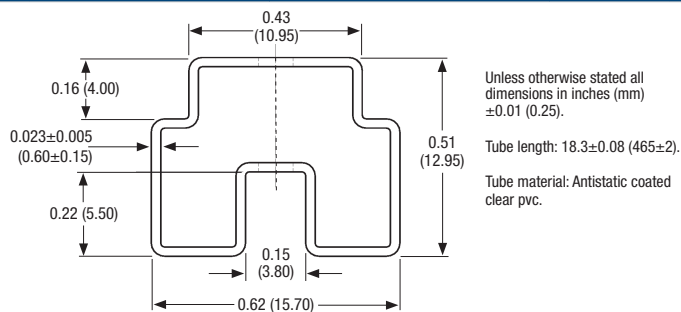

SOLDERING INFORMATION¹

Pin finish	Matte tin
Peak wave solder temperature	300°C for 10 seconds
Peak reflow temperature	220°C ²

- For further information, please visit www.murata-ps.com/rohs
- For high temperature reflow parts see 78250J Series.

TAPE & REEL SPECIFICATIONS

REEL OUTLINE DIMENSIONS

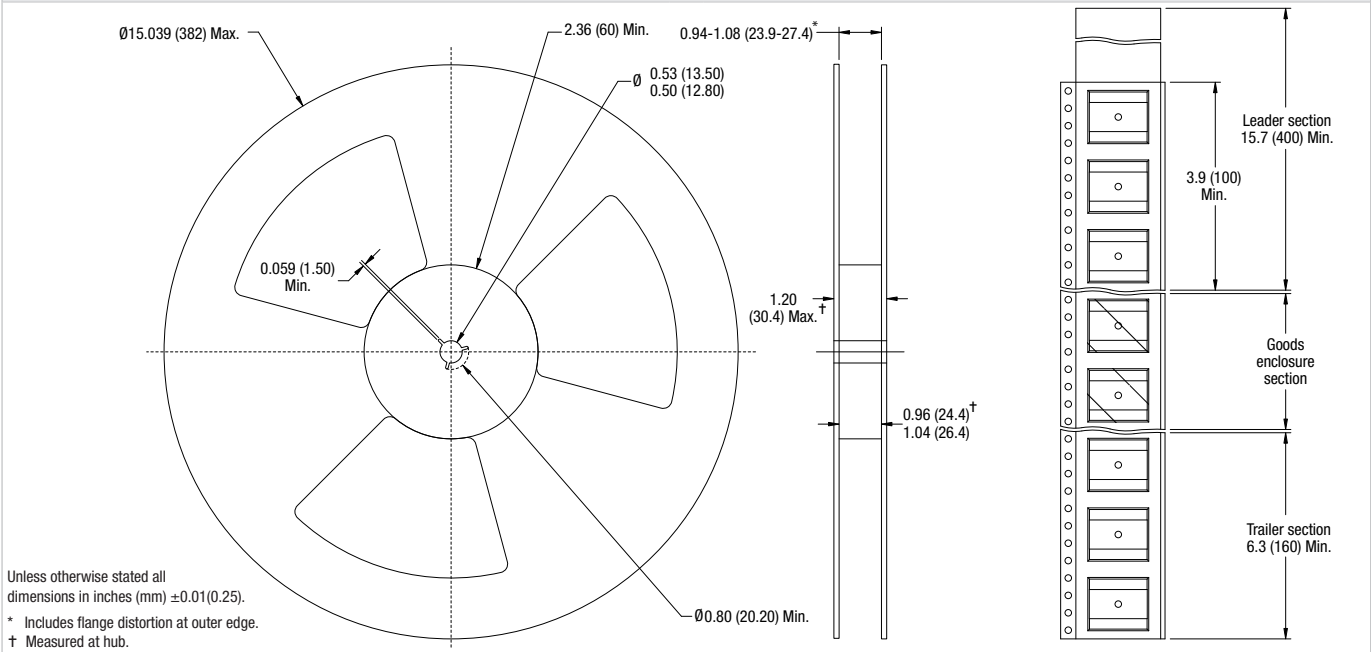

TAPE OUTLINE DIMENSIONS

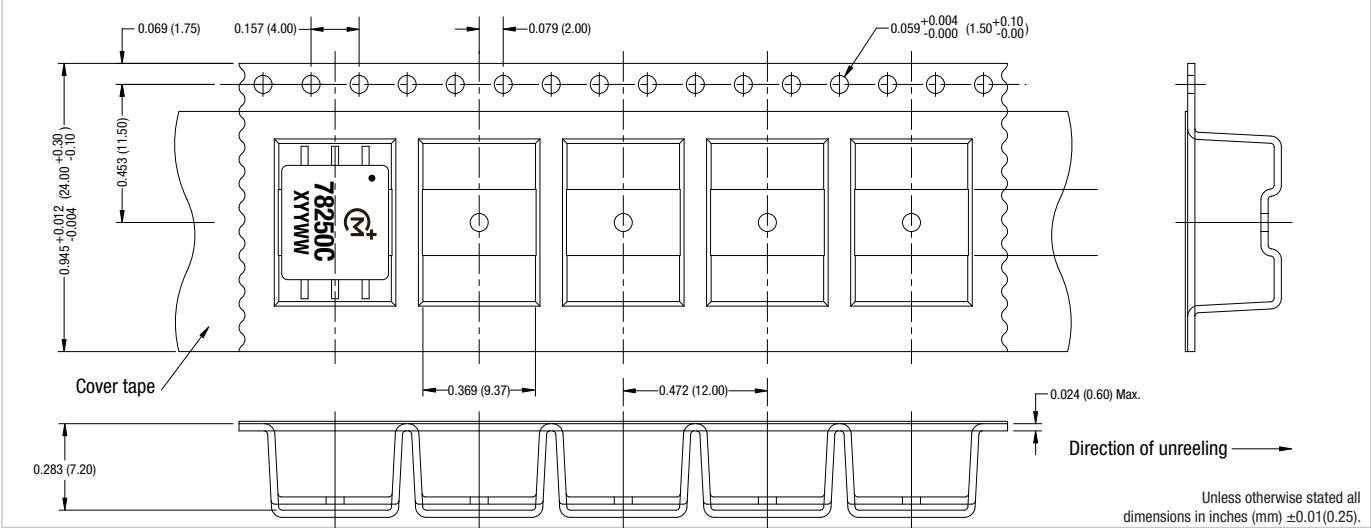

Murata Power Solutions, Inc.
 11 Cabot Boulevard, Mansfield, MA 02048-1151 U.S.A.
 ISO 9001 and 14001 REGISTERED

Murata Power Solutions, Inc. makes no representation that the use of its products in the circuits described herein, or the use of other technical information contained herein, will not infringe upon existing or future patent rights. The descriptions contained herein do not imply the granting of licenses to make, use, or sell equipment constructed in accordance therewith. Specifications are subject to change without notice.
 © 2011 Murata Power Solutions, Inc.