



Chipsmall Limited consists of a professional team with an average of over 10 year of expertise in the distribution of electronic components. Based in Hongkong, we have already established firm and mutual-benefit business relationships with customers from,Europe,America and south Asia,supplying obsolete and hard-to-find components to meet their specific needs.

With the principle of “Quality Parts,Customers Priority,Honest Operation,and Considerate Service”,our business mainly focus on the distribution of electronic components. Line cards we deal with include Microchip,ALPS,ROHM,Xilinx,Pulse,ON,Everlight and Freescale. Main products comprise IC,Modules,Potentiometer,IC Socket,Relay,Connector.Our parts cover such applications as commercial,industrial, and automotives areas.

We are looking forward to setting up business relationship with you and hope to provide you with the best service and solution. Let us make a better world for our industry!



Contact us

Tel: +86-755-8981 8866 Fax: +86-755-8427 6832

Email & Skype: info@chipsmall.com Web: www.chipsmall.com

Address: A1208, Overseas Decoration Building, #122 Zhenhua RD., Futian, Shenzhen, China



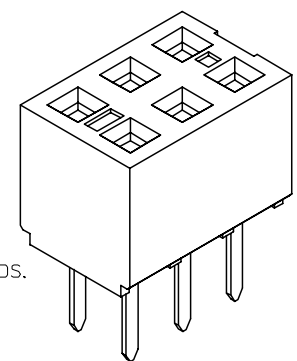
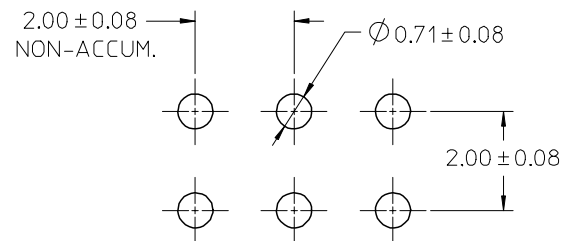
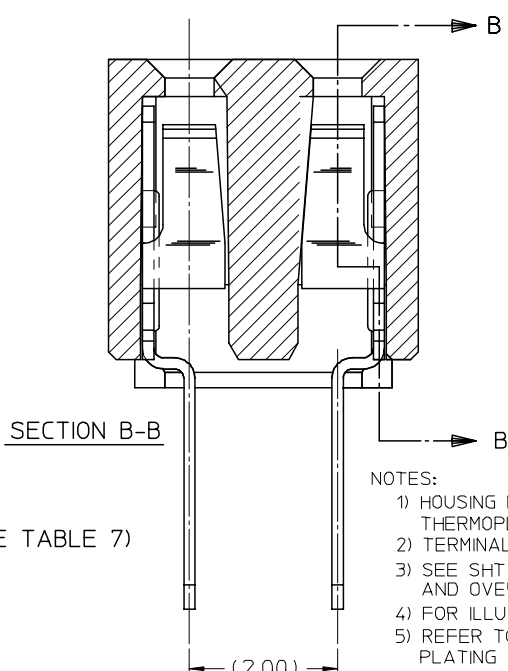
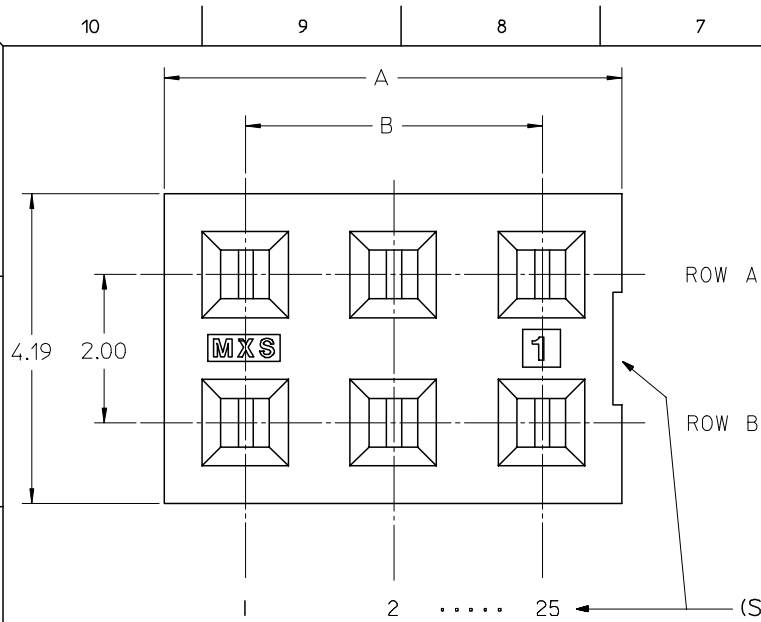

- NOTES:
- 1) HOUSING MATERIAL: GLASS FILLED HIGH TEMP THERMOPLASTIC, COLOR: BLACK
 - 2) TERMINAL MATERIAL: PHOSPHOR BRONZE
 - 3) SEE SHT 2 & 3 FOR CKT SIZE, PART NUMBERS AND OVERALL DIMENSIONS, SEE SHT 4 FOR VOIDS.
 - 4) FOR ILLUSTRATION, 6 CKT ASSY SHOWN.
 - 5) REFER TO PRODUCT SPEC PS-79107 PLATING OPTION 3 NOT COVERED BY PS-79107.
 - 6) PACKAGING PER PK-70873-0180
 - 7) CKTS NUMBERED FROM LEFT TO RIGHT WHEN PART IS VIEWED FROM TOP WITH RECESS ON THE RIGHT AS SHOWN.
 - 8) SOLDER TAIL TO BE MEASURED BY PITCH GAUGE.

PLATING OPTION:

- | | |
|---|--|
| 1) - 30u"/0.76um MIN GOLD PLATE IN SELECTED AREA
75u"/1.90um MIN TIN/LEAD PLATE IN SELECTED AREA
BOTH OVER 50u"/1.25um MIN NICKEL OVERALL | 4) - 30u"/0.76um MIN GOLD PLATE IN SELECTED AREA
75u"/1.90um MIN TIN PLATE IN SELECTED AREA
BOTH OVER 50u"/1.25um MIN NICKEL OVERALL |
| 2) - 15u"/0.38um MIN GOLD PLATE IN SELECTED AREA
75u"/1.90um MIN TIN/LEAD PLATE IN SELECTED AREA
BOTH OVER 50u"/1.25um MIN NICKEL OVERALL | 5) - 15u"/0.38um MIN GOLD PLATE IN SELECTED AREA
75u"/1.90um MIN TIN PLATE IN SELECTED AREA
BOTH OVER 50u"/1.25um MIN NICKEL OVERALL |
| 3) - 2u"/0.05um MIN GOLD PLATE IN SELECTED AREA
40u"/1.02um MIN TIN/LEAD PLATE IN SELECTED AREA
BOTH OVER 40u"/1.02um MIN NICKEL OVERALL | 6) - 2u"/0.05um MIN GOLD PLATE IN SELECTED AREA
40u"/1.02um MIN TIN PLATE IN SELECTED AREA
BOTH OVER 40u"/1.02um MIN NICKEL OVERALL |

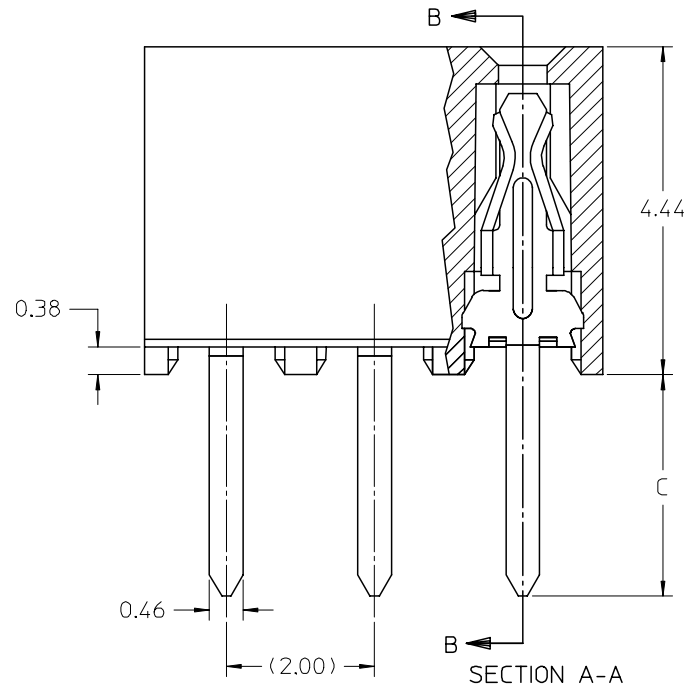

UPDATE TOLERANCE EC NO: S2006-0673 DRWN: LIAO 2006/01/05 CHKD: BOKOK 2006/01/06 APPR: PTLIM 2006/01/07	QUALITY SYMBOLS ▽=0 ▽=0	GENERAL TOLERANCES (UNLESS SPECIFIED)		DIMENSION STYLE MM ONLY		SCALE NTS	DESIGN UNITS METRIC	THIRD ANGLE PROJECTION		
				DRAWN BY AAB		DATE 1989/05/15		TITLE 2MM DUAL ROW VERTICAL RECEPTACLE T/H		
				CHECKED BY MJM		DATE 1989/05/15		MOLEX INCORPORATED		
				APPROVED BY WAZ		DATE 1989/05/15		DOCUMENT NO. SDA-79107-****		
		ANGULAR ±1/2°		MATERIAL NO.		DOCUMENT NO.		SHEET NO.		
		DRAFT WHERE APPLICABLE MUST REMAIN WITHIN DIMENSIONS		SEE TABLE		SDA-79107-****		1 OF 4		
				SIZE A3		THIS DRAWING CONTAINS INFORMATION THAT IS PROPRIETARY TO MOLEX INCORPORATED AND SHOULD NOT BE USED WITHOUT WRITTEN PERMISSION				



TIN/LEAD OPTION

P.C.TAIL DIMENSION 'C' = 3.00

P.C.TAIL DIMENSION 'C' = 1.91

CKT SIZE	DIM 'A'	DIM 'B'	PLATING OPTION 2			PLATING OPTION 1			PLATING OPTION 3					
			ITEM NO.	ITEM NO.	ITEM NO.	ITEM NO.	ITEM NO.	ITEM NO.	ITEM NO.	ITEM NO.	ITEM NO.			
04	(4.19)	(2.00)		79107-0001		79107-0051	X	79107-0126		79107-0201		79107-0251	X	79107-0326
06	(6.19)	(4.00)		79107-0002		79107-0052	X	79107-0127		79107-0202		79107-0252	X	79107-0327
08	(8.19)	(6.00)		79107-0003		79107-0053	X	79107-0128		79107-0203		79107-0253	X	79107-0328
10	(10.19)	(8.00)		79107-0004		79107-0054	X	79107-0129		79107-0204		79107-0254	X	79107-0329
12	(12.19)	(10.00)		79107-0005		79107-0055		79107-0130		79107-0205		79107-0255		79107-0330
14	(14.19)	(12.00)		79107-0006		79107-0056	X	79107-0131		79107-0206		79107-0256	X	79107-0331
16	(16.19)	(14.00)		79107-0007		79107-0057	X	79107-0132		79107-0207		79107-0257	X	79107-0332
18	(18.19)	(16.00)		79107-0008		79107-0058	X	79107-0133		79107-0208		79107-0258	X	79107-0333
20	(20.19)	(18.00)		79107-0009		79107-0059	X	79107-0134		79107-0209		79107-0259	X	79107-0334
22	(22.19)	(20.00)		79107-0010		79107-0060	X	79107-0135		79107-0210		79107-0260	X	79107-0335
24	(24.19)	(22.00)		79107-0011		79107-0061	X	79107-0136		79107-0211		79107-0261	X	79107-0336
26	(26.19)	(24.00)		79107-0012		79107-0062	X	79107-0137		79107-0212		79107-0262	X	79107-0337
28	(28.19)	(26.00)		79107-0013		79107-0063	X	79107-0138		79107-0213		79107-0263	X	79107-0338
30	(30.19)	(28.00)		79107-0014		79107-0064	X	79107-0139		79107-0214		79107-0264	X	79107-0339
32	(32.19)	(30.00)		79107-0015		79107-0065	X	79107-0140		79107-0215		79107-0265	X	79107-0340
34	(34.19)	(32.00)		79107-0016		79107-0066	X	79107-0141		79107-0216		79107-0266	X	79107-0341
36	(36.19)	(34.00)		79107-0017		79107-0067	X	79107-0142		79107-0217		79107-0267	X	79107-0342
38	(38.19)	(36.00)		79107-0018		79107-0068	X	79107-0143		79107-0218		79107-0268	X	79107-0343
40	(40.19)	(38.00)		79107-0019		79107-0069	X	79107-0144		79107-0219		79107-0269	X	79107-0344
42	(42.19)	(40.00)		79107-0020		79107-0070	X	79107-0145		79107-0220		79107-0270	X	79107-0345
44	(44.19)	(42.00)		79107-0021		79107-0071	X	79107-0146		79107-0221		79107-0271	X	79107-0346
46	(46.19)	(44.00)		79107-0022		79107-0072	X	79107-0147		79107-0222		79107-0272	X	79107-0347
48	(48.19)	(46.00)		79107-0023		79107-0073	X	79107-0148		79107-0223		79107-0273	X	79107-0348
50	(50.19)	(48.00)		79107-0024		79107-0074	X	79107-0149		79107-0224		79107-0274	X	79107-0349

X - DENOTES THE ITEM IS NOT AVAILABLE CURRENTLY.

UPDATE TOLERANCE EC NO: S2006-0673 DRWN: LOJ/AO 2006/01/05 CHKD: BOK/K 2006/01/06 APPR: PTL/IM 2006/01/07	QUALITY SYMBOLS  = 0  = 0.05	GENERAL TOLERANCES (UNLESS SPECIFIED)		DIMENSION STYLE MM ONLY		SCALE NTS	DESIGN UNITS METRIC	 THIRD ANGLE PROJECTION	
		4 PLACES ± --- ± ---	DRAWN BY AAB	DATE 1989/05/15	TITLE 2MM DUAL ROW VERTICAL RECEPTACLE T/H				
		3 PLACES ± --- ± ---	CHECKED BY MJM	DATE 1989/05/15					
		2 PLACES ± 0.25 ± ---	APPROVED BY WAZ		DATE 1989/05/15	MOLEX INCORPORATED			
1 PLACE ± 0.38 ± ---	MATERIAL NO. SEE TABLE		DOCUMENT NO. SDA-79107-****	SHEET NO. 2 OF 4					
DRAFT WHERE APPLICABLE MUST REMAIN WITHIN DIMENSIONS		SIZE A3	THIS DRAWING CONTAINS INFORMATION THAT IS PROPRIETARY TO MOLEX INCORPORATED AND SHOULD NOT BE USED WITHOUT WRITTEN PERMISSION						

TIN OPTION

CKT SIZE	DIM 'A'	DIM 'B'	P.C.TAIL DIMENSION 'C' = 3.00			P.C.TAIL DIMENSION 'C' = 1.91		
			PLATING OPTION 5	PLATING OPTION 4	PLATING OPTION 6	PLATING OPTION 5	PLATING OPTION 4	PLATING OPTION 6
			ITEM NO.	ITEM NO.	ITEM NO.	ITEM NO.	ITEM NO.	ITEM NO.
04	(4.19)	(2.00)	79107-7001	79107-7051	X 79107-7126	79107-7201	79107-7251	X 79107-7326
06	(6.19)	(4.00)	79107-7002	79107-7052	X 79107-7127	79107-7202	79107-7252	X 79107-7327
08	(8.19)	(6.00)	79107-7003	79107-7053	X 79107-7128	79107-7203	79107-7253	X 79107-7328
10	(10.19)	(8.00)	79107-7004	79107-7054	X 79107-7129	79107-7204	79107-7254	X 79107-7329
12	(12.19)	(10.00)	79107-7005	79107-7055	X 79107-7130	79107-7205	79107-7255	X 79107-7330
14	(14.19)	(12.00)	79107-7006	79107-7056	X 79107-7131	79107-7206	79107-7256	X 79107-7331
16	(16.19)	(14.00)	79107-7007	79107-7057	X 79107-7132	79107-7207	79107-7257	X 79107-7332
18	(18.19)	(16.00)	79107-7008	79107-7058	X 79107-7133	79107-7208	79107-7258	X 79107-7333
20	(20.19)	(18.00)	79107-7009	79107-7059	X 79107-7134	79107-7209	79107-7259	X 79107-7334
22	(22.19)	(20.00)	79107-7010	79107-7060	X 79107-7135	79107-7210	79107-7260	X 79107-7335
24	(24.19)	(22.00)	79107-7011	79107-7061	X 79107-7136	79107-7211	79107-7261	X 79107-7336
26	(26.19)	(24.00)	79107-7012	79107-7062	X 79107-7137	79107-7212	79107-7262	X 79107-7337
28	(28.19)	(26.00)	79107-7013	79107-7063	X 79107-7138	79107-7213	79107-7263	X 79107-7338
30	(30.19)	(28.00)	79107-7014	79107-7064	X 79107-7139	79107-7214	79107-7264	X 79107-7339
32	(32.19)	(30.00)	79107-7015	79107-7065	X 79107-7140	79107-7215	79107-7265	X 79107-7340
34	(34.19)	(32.00)	79107-7016	79107-7066	X 79107-7141	79107-7216	79107-7266	X 79107-7341
36	(36.19)	(34.00)	79107-7017	79107-7067	X 79107-7142	79107-7217	79107-7267	X 79107-7342
38	(38.19)	(36.00)	79107-7018	79107-7068	X 79107-7143	79107-7218	79107-7268	X 79107-7343
40	(40.19)	(38.00)	79107-7019	79107-7069	X 79107-7144	79107-7219	79107-7269	X 79107-7344
42	(42.19)	(40.00)	79107-7020	79107-7070	X 79107-7145	79107-7220	79107-7270	X 79107-7345
44	(44.19)	(42.00)	79107-7021	79107-7071	X 79107-7146	79107-7221	79107-7271	X 79107-7346
46	(46.19)	(44.00)	79107-7022	79107-7072	X 79107-7147	79107-7222	79107-7272	X 79107-7347
48	(48.19)	(46.00)	79107-7023	79107-7073	X 79107-7148	79107-7223	79107-7273	X 79107-7348
50	(50.19)	(48.00)	79107-7024	79107-7074	X 79107-7149	79107-7224	79107-7274	X 79107-7349

X - DENOTES THE ITEM IS NOT AVAILABLE CURRENTLY.

UPDATE TOLERANCE EC NO: S2006-0673 DRWN: LOI/AO 2006/01/05 CHKD: BOKOK 2006/01/06 APPR: PTL/IM 2006/01/07	QUALITY SYMBOLS ▽=0 ▽=0	GENERAL TOLERANCES (UNLESS SPECIFIED)	DIMENSION STYLE MM ONLY	SCALE NTS	DESIGN UNITS METRIC	THIRD ANGLE PROJECTION
		4 PLACES ± --- ± --- 3 PLACES ± --- ± --- 2 PLACES ± 0.25 ± --- 1 PLACE ± 0.38 ± --- ANGULAR ±1/2°	DRAWN BY AAB 1989/05/15 CHECKED BY MJM 1989/05/15 APPROVED BY WAZ 1989/05/15	TITLE 2MM DUAL ROW VERTICAL RECEPTACLE T/H		
		DRAFT WHERE APPLICABLE MUST REMAIN WITHIN DIMENSIONS	MATERIAL NO. SEE TABLE	DOCUMENT NO. SDA-79107-****	SHEET NO. 3 OF 4	
		THIS DRAWING CONTAINS INFORMATION THAT IS PROPRIETARY TO MOLEX INCORPORATED AND SHOULD NOT BE USED WITHOUT WRITTEN PERMISSION				

MOLDED VOID OPTION
ASSEMBLIES WITHOUT PEGS

CKT. SIZE	ASSEMBLY		VOID LOCATION(S) SEE SHEET 1 FOR CONVENTION		PLATING OPTION	DIM. "A"	DIM. "B"	P.C. TAIL DIM. "C"	PLATING OPTION
	ITEM NO.	ROW	CKT. NO.(s)						
24	79107-5001				2	(24.19)	(22.00)	(3.00)	TIN/LEAD
		ROW B	6						
10	79107-5002				2	(10.19)	(8.00)	(3.00)	
		ROW A	5						
26	79107-5003				2	(26.19)	(24.00)	(3.00)	TIN
		ROW B	5						
24	79107-5101				5	(24.19)	(22.00)	(3.00)	
		ROW B	6						
10	79107-5102				5	(10.19)	(8.00)	(3.00)	
		ROW A	5						
26	79107-5103				5	(26.19)	(24.00)	(3.00)	
		ROW B	5						

"X" - DENOTES THE ITEM IS NOT AVAILABLE CURRENTLY.

NOTES

1. TERMINALS WILL BE PRESENT IN VOIDED LOCATIONS HOWEVER, PIN WINDOWS WILL BE CLOSED.
2. VOIDS CANNOT BE PRESENT IN BOTH ROWS ON A CONNECTOR.

UPDATE TOLERANCE EC NO: S2006-0673 DRWN: LOIAO CHKD: BOKK APPR: PTLIM	2006/01/05 2006/01/06 2006/01/07	QUALITY SYMBOLS ▽=0 ▽C=0	GENERAL TOLERANCES (UNLESS SPECIFIED)		DIMENSION STYLE MM ONLY		SCALE NTS	DESIGN UNITS METRIC	THIRD ANGLE PROJECTION			
					mm	INCH	DRAWN BY AAB	DATE 1989/05/15	TITLE 2MM DUAL ROW VERTICAL RECEPTACLE T/H			
			4 PLACES	± ---	± ---	± ---	CHECKED BY MJM	DATE 1989/05/15				
			3 PLACES	± ---	± ---	± ---	APPROVED BY WAZ	DATE 1989/05/15	MOLEX INCORPORATED			
2 PLACES	± 0.25	± ---	± ---	MATERIAL NO.	DOCUMENT NO. SDA-79107-****	SHEET NO. 4 OF 4						
1 PLACE	± 0.38	± ---	± ---	DRAFT WHERE APPLICABLE MUST REMAIN WITHIN DIMENSIONS		SEE TABLE						
ANGULAR ±1/2°												