



Chipsmall Limited consists of a professional team with an average of over 10 year of expertise in the distribution of electronic components. Based in Hongkong, we have already established firm and mutual-benefit business relationships with customers from,Europe,America and south Asia,supplying obsolete and hard-to-find components to meet their specific needs.

With the principle of “Quality Parts,Customers Priority,Honest Operation,and Considerate Service”,our business mainly focus on the distribution of electronic components. Line cards we deal with include Microchip,ALPS,ROHM,Xilinx,Pulse,ON,Everlight and Freescale. Main products comprise IC,Modules,Potentiometer,IC Socket,Relay,Connector.Our parts cover such applications as commercial,industrial, and automotives areas.

We are looking forward to setting up business relationship with you and hope to provide you with the best service and solution. Let us make a better world for our industry!



Contact us

Tel: +86-755-8981 8866 Fax: +86-755-8427 6832

Email & Skype: info@chipsmall.com Web: www.chipsmall.com

Address: A1208, Overseas Decoration Building, #122 Zhenhua RD., Futian, Shenzhen, China



Device Overview

The 79RC32435 is a member of the IDT™ Interprise™ family of PCI integrated communications processors. It incorporates a high performance CPU core and a number of on-chip peripherals. The integrated processor is designed to transfer information from I/O modules to main memory with minimal CPU intervention, using a highly sophisticated direct memory access (DMA) engine. All data transfers through the RC32435 are achieved by writing data from an on-chip I/O peripheral to main memory and then out to another I/O module.

Features

◆ 32-bit CPU Core

- MIPS32 instruction set
- Cache Sizes: 8KB instruction and data caches, 4-Way set associative, cache line locking, non-blocking prefetches
- 16 dual-entry JTLB with variable page sizes
- 3-entry instruction TLB
- 3-entry data TLB
- Max issue rate of one 32x16 multiply per clock
- Max issue rate of one 32x32 multiply every other clock
- CPU control with start, stop, and single stepping
- Software breakpoints support
- Hardware breakpoints on virtual addresses
- ICE Interface that is compatible with v2.5 of the EJTAG Specification

◆ PCI Interface

- 32-bit PCI revision 2.2 compliant
- Supports host or satellite operation in both master and target modes
- Support for synchronous and asynchronous operation
- PCI clock supports frequencies from 16 MHz to 66 MHz
- PCI arbiter in Host mode: supports 6 external masters, fixed priority or round robin arbitration
- I²O "like" PCI Messaging Unit

◆ Ethernet Interface

- 10 and 100 Mb/s ISO/IEC 8802-3:1996 compliant
- Supports MII or RMII PHY interface
- Supports 64 entry hash table based multicast address filtering
- 512 byte transmit and receive FIFOs
- Supports flow control functions outlined in IEEE Std. 802.3x-1997

◆ DDR Memory Controller

- Supports up to 256MB of DDR SDRAM
- 1 chip select supporting 4 internal DDR banks
- Supports a 16-bit wide data port using x8 or x16 bit wide DDR SDRAM devices
- Supports 64 Mb, 128 Mb, 256 Mb, 512 Mb, and 1Gb DDR SDRAM devices
- Data bus multiplexing support allows interfacing to standard DDR DIMMs and SODIMMs
- Automatic refresh generation

Block Diagram

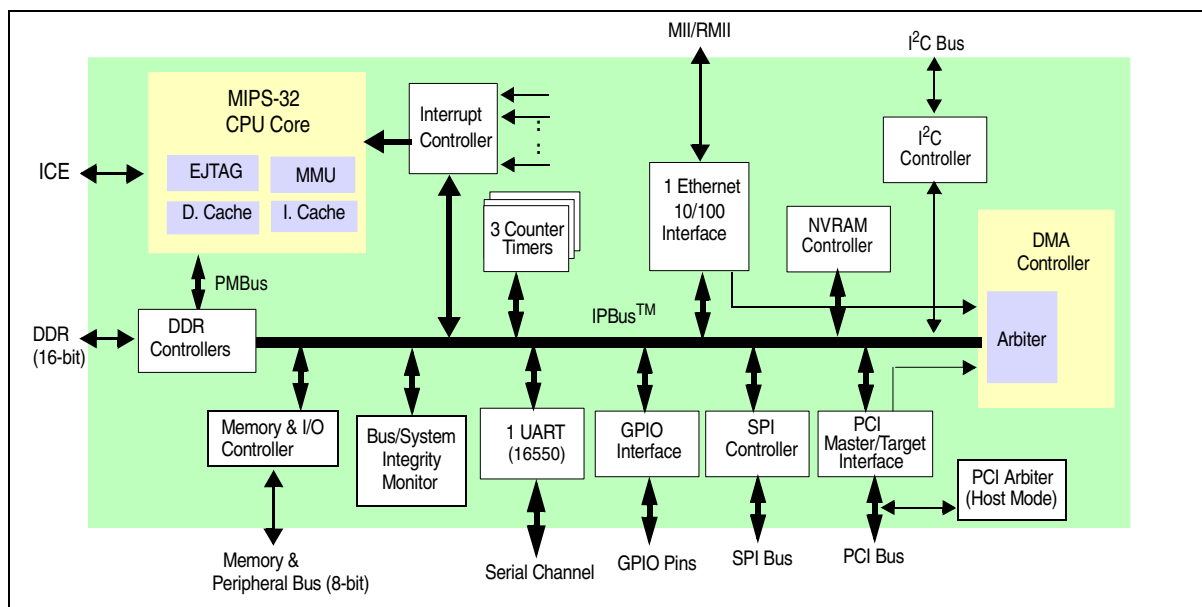

IDT and the IDT logo are trademarks of Integrated Device Technology, Inc.

◆ Non-Volatile RAM

- Provides 512-bits of non-volatile storage
- Eliminates need for external boot configuration vector
- Stores initial PCI configuration register values when PCI configured to operate in satellite mode with suspended CPU execution
- Authorization unit ensures only authorized software will operate on the system

◆ Memory and Peripheral Device Controller

- Provides “glueless” interface to standard SRAM, Flash, ROM, dual-port memory, and peripheral devices
- Demultiplexed address and data buses: 8-bit data bus, 26-bit address bus, 4 chip selects, control for external data bus buffers

Automatic byte gathering and scattering

- Flexible protocol configuration parameters: programmable number of wait states (0 to 63), programmable postread/post-write delay (0 to 31), supports external wait state generation, supports Intel and Motorola style peripherals
- Write protect capability per chip select
- Programmable bus transaction timer generates warm reset when counter expires
- Supports up to 64 MB of memory per chip select

◆ DMA Controller

- 6 DMA channels: two channels for PCI (PCI to Memory and Memory to PCI), two channels for the Ethernet interface, and two channels for memory to memory DMA operations
- Provides flexible descriptor based operation
- Supports unaligned transfers (i.e., source or destination address may be on any byte boundary) with arbitrary byte length

◆ Universal Asynchronous Receiver Transmitter (UART)

- Compatible with the 16550 and 16450 UARTs
- 16-byte transmit and receive buffers
- Programmable baud rate generator derived from the system clock
- Fully programmable serial characteristics:
 - 5, 6, 7, or 8 bit characters
 - Even, odd or no parity bit generation and detection
 - 1, 1-1/2 or 2 stop bit generation
- Line break generation and detection
- False start bit detection
- Internal loopback mode

◆ I²C-Bus

- Supports standard 100 Kbps mode as well as 400 Kbps fast mode
- Supports 7-bit and 10-bit addressing
- Supports four modes: master transmitter, master receiver, slave transmitter, slave receiver

◆ Additional General Purpose Peripherals

- Interrupt controller
- System integrity functions
- General purpose I/O controller
- Serial peripheral interface (SPI)

◆ Counter/Timers

- Three general purpose 32-bit counter timers
- Timers may be cascaded
- Selectable counter/timer clock source

◆ JTAG Interface

- Compatible with IEEE Std. 1149.1 - 1990

CPU Execution Core

The 32-bit CPU core is 100% compatible with the MIPS32 instruction set architecture (ISA). Specifically, this device features the 4Kc CPU core developed by MIPS Technologies Inc. (www.mips.com). This core issues a single instruction per cycle, includes a five stage pipeline and is optimized for applications that require integer arithmetic.

The CPU core includes 8 KB instruction and 8 KB data caches. Both caches are 4-way set associative and can be locked on a per line basis, which allows the programmer control over this precious on-chip memory resource. The core also features a memory management unit (MMU). The CPU core also incorporates an enhanced joint test access group (EJTAG) interface that is used to interface to in-circuit emulator tools, providing access to internal registers and enabling the part to be controlled externally, simplifying the system debug process.

The use of this core allows IDT's customers to leverage the broad range of software and development tools available for the MIPS architecture, including operating systems, compilers, and in-circuit emulators.

PCI Interface

The PCI interface on the RC32435 is compatible with version 2.2 of the PCI specification. An on-chip arbiter supports up to six external bus masters, supporting both fixed priority and rotating priority arbitration schemes. The part can support both satellite and host PCI configurations, enabling the RC32435 to act as a slave controller for a PCI add-in card application or as the primary PCI controller in the system. The PCI interface can be operated synchronously or asynchronously to the other I/O interfaces on the RC32435 device.

Ethernet Interface

The RC32435 has one Ethernet Channel supporting 10Mbps and 100Mbps speeds to provide a standard media independent interface (MII or RMII), allowing a wide range of external devices to be connected efficiently.

Double Data Rate Memory Controller

The RC32435 incorporates a high performance double data rate (DDR) memory controller which supports x16 memory configurations up to 256MB. This module provides all of the signals required to interface to discrete memory devices, including a chip select, differential clocking outputs and data strobes.

Memory and I/O Controller

The RC32435 uses a dedicated local memory/I/O controller including a de-multiplexed 8-bit data and 26-bit address bus. It includes all of the signals required to interface directly to a maximum of four Intel or Motorola-style external peripherals.

DMA Controller

The DMA controller consists of 6 independent DMA channels, all of which operate in exactly the same manner. The DMA controller off-loads the CPU core from moving data among the on-chip interfaces, external peripherals, and memory. The controller supports scatter/gather DMA with no alignment restrictions, making it appropriate for communications and graphics systems.

UART Interface

The RC32435 contains a serial channel (UART) that is compatible with the industry standard 16550 UART.

I²C Interface

The standard I2C interface allows the RC32435 to connect to a number of standard external peripherals for a more complete system solution. The RC32435 supports both master and slave operations.

General Purpose I/O Controller

The RC32435 has 14 general purpose input/output pins. Each pin may be used as an active high or active low level interrupt or non-maskable interrupt input, and each signal may be used as a bit input or output port.

System Integrity Functions

The RC32435 contains a programmable watchdog timer that generates a non-maskable interrupt (NMI) when the counter expires and also contains an address space monitor that reports errors in response to accesses to undecoded address regions.

Thermal Considerations

The RC32435 is guaranteed in an ambient temperature range of 0° to +70° C for commercial temperature devices and -40° to +85° for industrial temperature devices.

Revision History

January 19, 2006: Initial publication.

Pin Description Table

The following table lists the functions of the pins provided on the RC32435. Some of the functions listed may be multiplexed onto the same pin.

The active polarity of a signal is defined using a suffix. Signals ending with an “N” are defined as being active, or asserted, when at a logic zero (low) level. All other signals (including clocks, buses, and select lines) will be interpreted as being active, or asserted, when at a logic one (high) level.

Signal	Type	Name/Description
Memory and Peripheral Bus		
BDIRN	O	External Buffer Direction. Controls the direction of the external data bus buffer for the memory and peripheral bus. If the RC32435 memory and peripheral bus is connected to the A side of a transceiver, such as an IDT74FCT245, then this pin may be directly connected to the direction control (e.g., BDIR) pin of the transceiver.
BOEN	O	External Buffer Enable. This signal provides an output enable control for an external buffer on the memory and peripheral data bus.
WEN	O	Write Enables. This signal is the memory and peripheral bus write enable signal.
CSN[3:0]	O	Chip Selects. These signals are used to select an external device on the memory and peripheral bus.
MADDR[21:0]	O	Address Bus. 22-bit memory and peripheral bus address bus. MADDR[25:22] are available as GPIO alternate functions.
MDATA[7:0]	I/O	Data Bus. 8-bit memory and peripheral data bus. During a cold reset, these pins function as inputs that are used to load the boot configuration vector.
OEN	O	Output Enable. This signal is asserted when data should be driven by an external device on the memory and peripheral bus.
RWN	O	Read Write. This signal indicates whether the transaction on the memory and peripheral bus is a read transaction or a write transaction. A high level indicates a read from an external device. A low level indicates a write to an external device.
WAITACKN	I	Wait or Transfer Acknowledge. When configured as wait, this signal is asserted during a memory and peripheral bus transaction to extend the bus cycle. When configured as a transfer acknowledge, this signal is asserted during a transaction to signal the completion of the transaction.
DDR Bus		
DDRADDR[13:0]	O	DDR Address Bus. 14-bit multiplexed DDR address bus. This bus is used to transfer the addresses to the DDR devices.
DDRBA[1:0]	O	DDR Bank Address. These signals are used to transfer the bank address to the DDRs.
DDRCASN	O	DDR Column Address Strobe. This signal is asserted during DDR transactions.
DDRCKE	O	DDR Clock Enable. The DDR clock enable signal is asserted during normal DDR operation. This signal is negated following a cold reset or during a power down operation.
DDRCKN	O	DDR Negative DDR clock. This signal is the negative clock of the differential DDR clock pair.

Table 1 Pin Description (Part 1 of 6)

Signal	Type	Name/Description
DDRCKP	O	DDR Positive DDR clock. This signal is the positive clock of the differential DDR clock pair.
DDRCSN	O	DDR Chip Selects. This active low signal is used to select DDR device(s) on the DDR bus.
DDRDATA[15:0]	I/O	DDR Data Bus. 16-bit DDR data bus is used to transfer data between the RC32435 and the DDR devices. Data is transferred on both edges of the clock.
DDRDM[1:0]	O	DDR Data Write Enables. Byte data write enables are used to enable specific byte lanes during DDR writes. DDRDM[0] corresponds to DDRDATA[7:0] DDRDM[1] corresponds to DDRDATA[15:8]
DDRDQS[1:0]	I/O	DDR Data Strobes. DDR byte data strobes are used to clock data between DDR devices and the RC32435. These strobes are inputs during DDR reads and outputs during DDR writes. DDRDQS[0] corresponds to DDRDATA[7:0] DDRDQS[1] corresponds to DDRDATA[15:8]
DDRRASN	O	DDR Row Address Strobe. The DDR row address strobe is asserted during DDR transactions.
DDRVREF	I	DDR Voltage Reference. SSTL_2 DDR voltage reference is generated by an external source.
DDRWEN	O	DDR Write Enable. DDR write enable is asserted during DDR write transactions.
PCI Bus		
PCIAD[31:0]	I/O	PCI Multiplexed Address/Data Bus. Address is driven by a bus master during initial PCIFRAMEN assertion. Data is then driven by the bus master during writes or by the bus target during reads.
PCIBEN[3:0]	I/O	PCI Multiplexed Command/Byte Enable Bus. PCI commands are driven by the bus master during the initial PCIFRAMEN assertion. Byte enable signals are driven by the bus master during subsequent data phase(s).
PCICLK	I	PCI Clock. Clock used for all PCI bus transactions.
PCIDEVSELN	I/O	PCI Device Select. This signal is driven by a bus target to indicate that the target has decoded the address as one of its own address spaces.
PCIFRAMEN	I/O	PCI Frame. Driven by a bus master. Assertion indicates the beginning of a bus transaction. Negation indicates the last data.
PCIGNTN[3:0]	I/O	PCI Bus Grant. In PCI host mode with internal arbiter: The assertion of these signals indicates to the agent that the internal RC32435 arbiter has granted the agent access to the PCI bus. In PCI host mode with external arbiter: PCIGNTN[0]: asserted by an external arbiter to indicate to the RC32435 that access to the PCI bus has been granted. PCIGNTN[3:1]: unused and driven high. In PCI satellite mode: PCIGNTN[0]: This signal is asserted by an external arbiter to indicate to the RC32435 that access to the PCI bus has been granted. PCIGNTN[3:1]: unused and driven high.
PCIIRDYN	I/O	PCI Initiator Ready. Driven by the bus master to indicate that the current datum can complete.

Table 1 Pin Description (Part 2 of 6)

Signal	Type	Name/Description
PCILOCKN	I/O	PCI Lock. This signal is asserted by an external bus master to indicate that an exclusive operation is occurring.
PCIPAR	I/O	PCI Parity. Even parity of the PCIAD[31:0] bus. Driven by the bus master during address and write Data phases. Driven by the bus target during the read data phase.
PCIPERRN	I/O	PCI Parity Error. If a parity error is detected, this signal is asserted by the receiving bus agent 2 clocks after the data is received.
PCIREQN[3:0]	I/O	PCI Bus Request. In PCI host mode with internal arbiter: These signals are inputs whose assertion indicates to the internal RC32435 arbiter that an agent desires ownership of the PCI bus. In PCI host mode with external arbiter: PCIREQN[0]: asserted by the RC32435 to request ownership of the PCI bus. PCIREQN[3:1]: unused and driven high. In PCI satellite mode: PCIREQN[0]: this signal is asserted by the RC32435 to request use of the PCI bus. PCIREQN[1]: function changes to PCIIDSEL and is used as a chip select during configuration read and write transactions. PCIREQN[3:2]: unused and driven high.
PCIRSTN	I/O	PCI Reset. In host mode, this signal is asserted by the RC32435 to generate a PCI reset. In satellite mode, assertion of this signal initiates a warm reset.
PCISERRN	I/O	PCI System Error. This signal is driven by an agent to indicate an address parity error, data parity error during a special cycle command, or any other system error. Requires an external pull-up.
PCISTOPN	I/O	PCI Stop. Driven by the bus target to terminate the current bus transaction. For example, to indicate a retry.
PCITRDYN	I/O	PCI Target Ready. Driven by the bus target to indicate that the current data can complete.
General Purpose Input/Output		
GPIO[0]	I/O	General Purpose I/O. This pin can be configured as a general purpose I/O pin. Alternate function pin name: U0SOUT Alternate function: UART channel 0 serial output.
GPIO[1]	I/O	General Purpose I/O. This pin can be configured as a general purpose I/O pin. Alternate function pin name: U0SINP Alternate function: UART channel 0 serial input.
GPIO[2]	I/O	General Purpose I/O. This pin can be configured as a general purpose I/O pin. Alternate function pin name: U0RTSN Alternate function: UART channel 0 request to send.
GPIO[3]	I/O	General Purpose I/O. This pin can be configured as a general purpose I/O pin. Alternate function pin name: U0CTSN Alternate function: UART channel 0 clear to send.

Table 1 Pin Description (Part 3 of 6)

Signal	Type	Name/Description
GPIO[4]	I/O	General Purpose I/O. This pin can be configured as a general purpose I/O pin. Alternate function pin name: MADDR[22] Alternate function: Memory and peripheral bus address.
GPIO[5]	I/O	General Purpose I/O. This pin can be configured as a general purpose I/O pin. Alternate function pin name: MADDR[23] Alternate function: Memory and peripheral bus address.
GPIO[6]	I/O	General Purpose I/O. This pin can be configured as a general purpose I/O pin. Alternate function pin name: MADDR[24] Alternate function: Memory and peripheral bus address. The value of this pin may be used as a counter timer clock input (see Counter Timer Clock Select Register in Chapter 14, Counter/Timers, of the RC32435 User Manual).
GPIO[7]	I/O	General Purpose I/O. This pin can be configured as a general purpose I/O pin. Alternate function pin name: MADDR[25] Alternate function: Memory and peripheral bus address. The value of this pin may be used as a counter timer clock input (see Counter Timer Clock Select Register in Chapter 14, Counter/Timers, of the RC32435 User Manual).
GPIO[8]	I/O	General Purpose I/O. This pin can be configured as a general purpose I/O pin. Alternate function pin name: CPU Alternate function: CPU or DMA debug output pin.
GPIO[9]	I/O	General Purpose I/O. This pin can be configured as a general purpose I/O pin. Alternate function pin name: PCIREQN[4] Alternate function: PCI Request 4.
GPIO[10]	I/O	General Purpose I/O. This pin can be configured as a general purpose I/O pin. Alternate function pin name: PCIGNTN[4] Alternate function: PCI Grant 4.
GPIO[11]	I/O	General Purpose I/O. This pin can be configured as a general purpose I/O pin. Alternate function pin name: PCIREQN[5] Alternate function: PCI Request 5.
GPIO[12]	I/O	General Purpose I/O. This pin can be configured as a general purpose I/O pin. Alternate function pin name: PCIGNTN[5] Alternate function: PCI Grant 5.
GPIO[13]	I/O	General Purpose I/O. This pin can be configured as a general purpose I/O pin. Alternate function pin name: PCIMUINTN Alternate function: PCI Messaging unit interrupt output.
SPI Interface		
SCK	I/O	Serial Clock. This signal is used as the serial clock output. This pin may be used as a bit input/output port.

Table 1 Pin Description (Part 4 of 6)

Signal	Type	Name/Description
SDI	I/O	Serial Data Input. This signal is used to shift in serial data. This pin may be used as a bit input/output port.
SDO	I/O	Serial Data Output. This signal is used shift out serial data.
I²C Bus Interface		
SCL	I/O	I²C Clock. I ² C-bus clock.
SDA	I/O	I²C Data Bus. I ² C-bus data bus.
Ethernet Interfaces		
MIICL	I	Ethernet MII Collision Detected. This signal is asserted by the ethernet PHY when a collision is detected.
MIICRS	I	Ethernet MII Carrier Sense. This signal is asserted by the ethernet PHY when either the transmit or receive medium is not idle.
MIIRXCLK	I	Ethernet MII Receive Clock. This clock is a continuous clock that provides a timing reference for the reception of data. This pin also functions as the RMII REF_CLK input.
MIIRXD[3:0]	I	Ethernet MII Receive Data. This nibble wide data bus contains the data received by the ethernet PHY. This pin also functions as the RMII RXD[1:0] input.
MIIRXDV	I	Ethernet MII Receive Data Valid. The assertion of this signal indicates that valid receive data is in the MII receive data bus. This pin also functions as the RMII CRS_DV input.
MIIRXER	I	Ethernet MII Receive Error. The assertion of this signal indicates that an error was detected somewhere in the ethernet frame currently being sent in the MII receive data bus. This pin also functions as the RMII RX_ER input.
MIITXCLK	I	Ethernet MII Transmit Clock. This clock is a continuous clock that provides a timing reference for the transfer of transmit data.
MIITXD[3:0]	O	Ethernet MII Transmit Data. This nibble wide data bus contains the data to be transmitted. This pin also functions as the RMII TXD[1:0] output.
MIITXENP	O	Ethernet MII Transmit Enable. The assertion of this signal indicates that data is present on the MII for transmission. This pin also functions as the RMII TX_EN output.
MIITXER	O	Ethernet MII Transmit Coding Error. When this signal is asserted together with MIITXENP, the ethernet PHY will transmit symbols which are not valid data or delimiters.
MIIMDC	O	MII Management Data Clock. This signal is used as a timing reference for transmission of data on the management interface.
MIIMDIO	I/O	MII Management Data. This bidirectional signal is used to transfer data between the station management entity and the ethernet PHY.
EJTAG / JTAG		
JTAG_TMS	I	JTAG Mode. The value on this signal controls the test mode select of the boundary scan logic or JTAG Controller. When using the EJTAG debug interface, this pin should be left disconnected (since there is an internal pull-up) or driven high.

Table 1 Pin Description (Part 5 of 6)

Signal	Type	Name/Description
EJTAG_TMS	I	EJTAG Mode. The value on this signal controls the test mode select of the EJTAG Controller. When using the JTAG boundary scan, this pin should be left disconnected (since there is an internal pull-up) or driven high.
JTAG_TRST_N	I	JTAG Reset. This active low signal asynchronously resets the boundary scan logic, JTAG TAP Controller, and the EJTAG Debug TAP Controller. An external pull-up on the board is recommended to meet the JTAG specification in cases where the tester can access this signal. However, for systems running in functional mode, one of the following should occur: 1) actively drive this signal low with control logic 2) statically drive this signal low with an external pull-down on the board 3) clock JTAG_TCK while holding EJTAG_TMS and/or JTAG_TMS high.
JTAG_TCK	I	JTAG Clock. This is an input test clock used to clock the shifting of data into or out of the boundary scan logic, JTAG Controller, or the EJTAG Controller. JTAG_TCK is independent of the system and the processor clock with a nominal 50% duty cycle.
JTAG_TDO	O	JTAG Data Output. This is the serial data shifted out from the boundary scan logic, JTAG Controller, or the EJTAG Controller. When no data is being shifted out, this signal is tri-stated.
JTAG_TDI	I	JTAG Data Input. This is the serial data input to the boundary scan logic, JTAG Controller, or the EJTAG Controller.
System		
CLK	I	Master Clock. This is the master clock input. The processor frequency is a multiple of this clock frequency. This clock is used as the system clock for all memory and peripheral bus operations.
EXTBCV	I	Load External Boot Configuration Vector. When this pin is asserted (i.e., high) the boot configuration vector is loaded from an externally supplied value during a cold reset. When this pin is negated, the boot configuration vector is taken from the NVRAM located on-chip.
EXTCLK	O	External Clock. This clock is used for all memory and peripheral bus operations.
COLDRSTN	I	Cold Reset. The assertion of this signal initiates a cold reset. This causes the processor state to be initialized, boot configuration to be loaded, and the internal PLL to lock onto the master clock (CLK).
RSTN	I/O	Reset. The assertion of this bidirectional signal initiates a warm reset. This signal is asserted by the RC32435 during a warm reset.

Table 1 Pin Description (Part 6 of 6)

Pin Characteristics

Note: Some input pads of the RC32435 do not contain internal pull-ups or pull-downs. Unused inputs should be tied off to appropriate levels. This is especially critical for unused control signal inputs (such as WAITACKN) which, if left floating, could adversely affect the RC32435's operation. Also, any input pin left floating can cause a slight increase in power consumption.

Function	Pin Name	Type	Buffer	I/O Type	Internal Resistor	Notes ¹
Memory and Peripheral Bus	BDIRN	O	LVTTL	High Drive		
	BOEN	O	LVTTL	High Drive		
	WEN	O	LVTTL	High Drive		
	CSN[3:0]	O	LVTTL	High Drive		
	MADDR[21:0]	I/O	LVTTL	High Drive		
	MDATA[7:0]	I/O	LVTTL	High Drive		
	OEN	O	LVTTL	High Drive		
	RWN	O	LVTTL	High Drive		
	WAITACKN	I	LVTTL	STI	pull-up	
DDR Bus	DDRADDR[13:0]	O	SSTL_2			
	DDRBA[1:0]	O	SSTL_2			
	DDRCASN	O	SSTL_2			
	DDRCKE	O	SSTL_2 / LVC-MOS			
	DDRCKN	O	SSTL_2			
	DDRCKP	O	SSTL_2			
	DDRCASN	O	SSTL_2			
	DDRDATA[15:0]	I/O	SSTL_2			
	DDRDM[1:0]	O	SSTL_2			
	DDRQ[1:0]	I/O	SSTL_2			
	DDRRASN	O	SSTL_2			
	DDRVREF	I	Analog			
	DDRWEN	O	SSTL_2			
PCI Bus Interface	PCIAD[31:0]	I/O	PCI			
	PCIBEN[3:0]	I/O	PCI			
	PCICLK	I	PCI			
	PCIDEVSELN	I/O	PCI			pull-up on board
	PCIFRAMEN	I/O	PCI			pull-up on board
	PCIGNTN[3:0]	I/O	PCI			pull-up on board
	PCIIRDYN	I/O	PCI			pull-up on board
	PCIOCKN	I/O	PCI			
	PCIPAR	I/O	PCI			
	PCIPERRN	I/O	PCI			
	PCIREQN[3:0]	I/O	PCI			pull-up on board
	PCIRSTN	I/O	PCI			pull-down on board
	PCISERRN	I/O	PCI	Open Collector		pull-up on board
	PCISTOPN	I/O	PCI			pull-up on board
	PCITRDYN	I/O	PCI			pull-up on board
General Purpose I/O	GPIO[8:0]	I/O	LVTTL	High Drive	pull-up	
	GPIO[13:9]	I/O	PCI			pull-up on board

Table 2 Pin Characteristics (Part 1 of 2)

Function	Pin Name	Type	Buffer	I/O Type	Internal Resistor	Notes ¹
Serial Peripheral Interface	SCK	I/O	LVTTL	High Drive	pull-up	pull-up on board
	SDI	I/O	LVTTL	High Drive	pull-up	pull-up on board
	SDO	I/O	LVTTL	High Drive	pull-up	pull-up on board
I ² C-Bus Interface	SCL	I/O	LVTTL	Low Drive/STI		pull-up on board ²
	SDA	I/O	LVTTL	Low Drive/STI		pull-up on board ²
Ethernet Interfaces	MIICL	I	LVTTL	STI	pull-down	
	MIICRS	I	LVTTL	STI	pull-down	
	MIIRXCLK	I	LVTTL	STI	pull-up	
	MIIRXD[3:0]	I	LVTTL	STI	pull-up	
	MIIRXDV	I	LVTTL	STI	pull-down	
	MIIRXER	I	LVTTL	STI	pull-down	
	MIITXCLK	I	LVTTL	STI	pull-up	
	MIITXD[3:0]	O	LVTTL	Low Drive		
	MIITXENP	O	LVTTL	Low Drive		
	MIITXER	O	LVTTL	Low Drive		
	MIIMDC	O	LVTTL	Low Drive		
	MIIMDIO	I/O	LVTTL	Low Drive	pull-up	
EJTAG / JTAG	JTAG_TMS	I	LVTTL	STI	pull-up	
	EJTAG_TMS	I	LVTTL	STI	pull-up	
	JTAG_TRST_N	I	LVTTL	STI	pull-up	
	JTAG_TCK	I	LVTTL	STI	pull-up	
	JTAG_TDO	O	LVTTL	Low Drive		
	JTAG_TDI	I	LVTTL	STI	pull-up	
System	CLK	I	LVTTL	STI		
	EXTBCV	I	LVTTL	STI	pull-down	
	EXTCLK	O	LVTTL	High Drive		
	COLDRSTN	I	LVTTL	STI		
	RSTN	I/O	LVTTL	Low Drive / STI	pull-up	pull-up on board

Table 2 Pin Characteristics (Part 2 of 2)

¹ External pull-up required in most system applications. Some applications may require additional pull-ups not identified in this table.

² Use a 2.2K pull-up resistor for I2C pins.

Boot Configuration Vector

The encoding of the boot configuration vector is described in Table 3, and the vector input is illustrated in Figure 4. The value of the boot configuration vector read in by the RC32435 during a cold reset may be determined by reading the Boot Configuration Vector (BCV) Register.

Signal	Name/Description
MADDR[3:0]	<p>CPU Pipeline Clock Multiplier. This field specifies the value by which the PLL multiplies the master clock input (CLK) to obtain the processor clock frequency (PCLK). For master clock input frequency constraints, refer to Table 3.2 in the RC32435 User Manual.</p> <p>0x0 - PLL Bypass 0x1 - Multiply by 3 0x2 - Multiply by 4 0x3 - Multiply by 5 - Reserved 0x4 - Multiply by 5 0x5 - Multiply by 6 - Reserved 0x6 - Multiply by 6 0x7 - Multiply by 8 0x8 - Multiply by 10 0x9 through 0xF - Reserved</p>
MADDR[5:4]	<p>External Clock Divider. This field specifies the value by which the IPBus clock (ICLK), which is always 1/2 PCLK, is divided in order to generate the external clock output on the EXTCLK pin.</p> <p>0x0 - Divide by 1 0x1 - Divide by 2 0x2 - Divide by 4 0x3 - reserved</p>
MADDR[6]	<p>Endian. This bit specifies the endianness.</p> <p>0x0 - little endian 0x1 - big endian</p>
MADDR[7]	<p>Reset Mode. This bit specifies the length of time the RSTN signal is driven.</p> <p>0x0 - Normal reset: RSTN driven for minimum of 4000 clock cycles. If the internal boot configuration vector is selected, the expiration of an 18-bit counter operating at the master clock input (CLK) frequency is used as the PLL stabilization delay. 0x1 - Reserved</p>
MADDR[10:8]	<p>PCI Mode. This bit controls the operating mode of the PCI bus interface. The initial value of the EN bit in the PCIC register is determined by the PCI mode.</p> <p>0x0 - Disabled (EN initial value is zero) 0x1 - PCI satellite mode with PCI target not ready (EN initial value is one) 0x2 - PCI satellite mode with suspended CPU execution (EN initial value is one) 0x3 - PCI host mode with external arbiter (EN initial value is zero) 0x4 - PCI host mode with internal arbiter using fixed priority arbitration algorithm (EN initial value is zero) 0x5 - PCI host mode with internal arbiter using round robin arbitration algorithm (EN initial value is zero) 0x6 - reserved 0x7 - reserved</p>

Table 3 Boot Configuration Encoding (Part 1 of 2)

Signal	Name/Description
MADDR[11]	Disable Watchdog Timer. When this bit is set, the watchdog timer is disabled following a cold reset. 0x0 - Watchdog timer enabled 0x1 - Watchdog timer disabled
MADDR[13:12]	Reserved. These pins must be driven low during boot configuration.
MADDR[15:14]	Reserved. Must be set to zero.

Table 3 Boot Configuration Encoding (Part 2 of 2)

Logic Diagram — RC32435

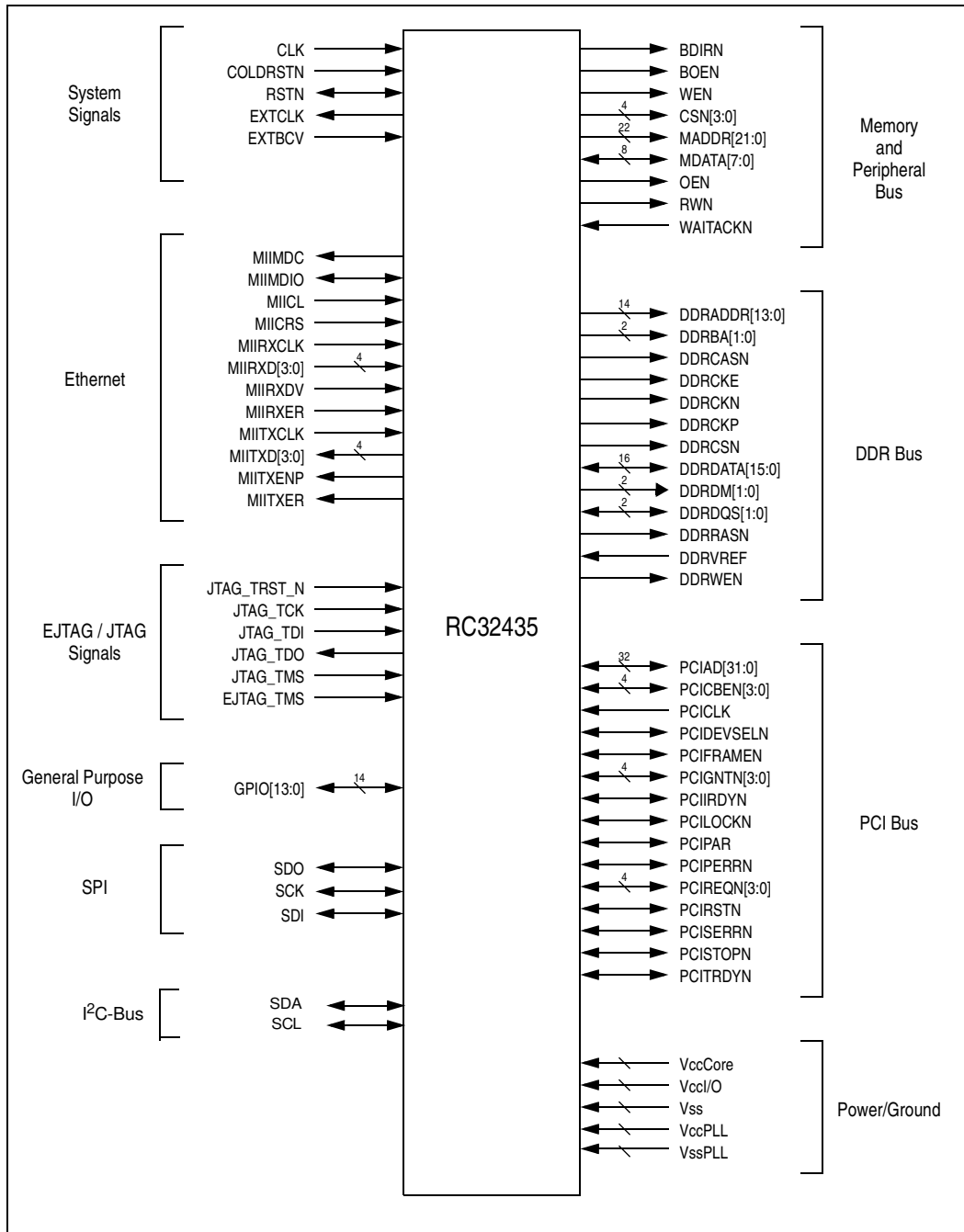

Figure 1 Logic Diagram

AC Timing Definitions

Below are examples of the AC timing characteristics used throughout this document.

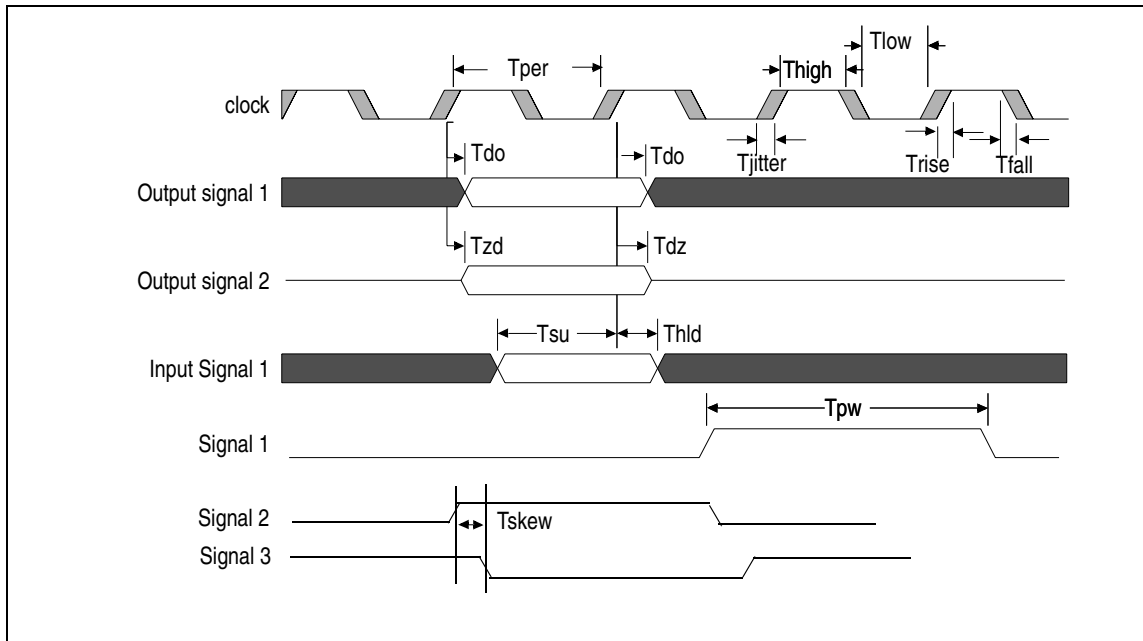

Figure 2 AC Timing Definitions Waveform

Symbol	Definition
Tper	Clock period.
Tlow	Clock low. Amount of time the clock is low in one clock period.
Thigh	Clock high. Amount of time the clock is high in one clock period.
Trise	Rise time. Low to high transition time.
Tfall	Fall time. High to low transition time.
Tjitter	Jitter. Amount of time the reference clock (or signal) edge can vary on either the rising or falling edges.
Tdo	Data out. Amount of time after the reference clock edge that the output will become valid. The minimum time represents the data output hold. The maximum time represents the earliest time the designer can use the data.
Tzd	Z state to data valid. Amount of time after the reference clock edge that the tri-stated output takes to become valid.
Tdz	Data valid to Z state. Amount of time after the reference clock edge that the valid output takes to become tri-stated.
Tsu	Input set-up. Amount of time before the reference clock edge that the input must be valid.
Thld	Input hold. Amount of time after the reference clock edge that the input must remain valid.
Tpw	Pulse width. Amount of time the input or output is active for asynchronous signals.
Tslew	Slew rate. The rise or fall rate for a signal to go from a high to low, or low to high.
X(clock)	Timing value. This notation represents a value of 'X' multiplied by the clock time period of the specified clock. Using 5(CLK) as an example: X = 5 and the oscillator clock (CLK) = 25MHz, then the timing value is 200.
Tskew	Skew. The amount of time two signal edges deviate from one another.

Table 4 AC Timing Definitions

System Clock Parameters

(Values based on systems running at recommended supply voltages and operating temperatures, as shown in Tables 15 and 16.)

Parameter	Symbol	Reference Edge	266MHz		300MHz		350MHz		400MHz		Units	Timing Diagram Reference
			Min	Max	Min	Max	Min	Max	Min	Max		
PCLK ¹	Frequency	none	200	266	200	300	200	350	200	400	MHz	See Figure 3.
	Tper		3.8	5.0	3.3	5.0	2.85	5.0	2.5	5.0	ns	
ICLK ^{2,3,4}	Frequency	none	100	133	100	150	100	175	100	200	MHz	
	Tper		7.5	10.0	6.7	10.0	5.7	10.0	5.0	10.0	ns	
CLK ⁵	Frequency	none	25	125	25	125	25	125	25	125	MHz	
	Tper_5a		8.0	40.0	8.0	40.0	8.0	40.0	8.0	40.0	ns	
	Thigh_5a, Tlow_5a		40	60	40	60	40	60	40	60	% of Tper_5a	
	Trise_5a, Tfall_5a		—	3.0	—	3.0	—	3.0	—	3.0	ns	
	Tjitter_5a		—	0.1	—	0.1	—	0.1	—	0.1	ns	

Table 5 Clock Parameters

1. The CPU pipeline clock (PCLK) speed is selected during cold reset by the boot configuration vector (see Table 3). Refer to Chapter 3, Clocking and Initialization, in the RC32435 User Reference Manual for the allowable frequency ranges of CLK and PCLK.
2. ICLK is the internal IPBus clock. It is always equal to PCLK divided by 2. This clock cannot be sampled externally.
3. The ethernet clock (MIIXRXCLK and MIIXTXCLK) frequency must be equal to or less than 1/2 ICLK (MIIXRXCLK and MIIXTXCLK <= 1/2(ICLK)).
4. PCICLK must be equal to or less than two times ICLK (PCICLK <= 2(ICLK)) with a maximum PCICLK of 66 MHz.
5. The input clock (CLK) is input from the external oscillator to the internal PLL.

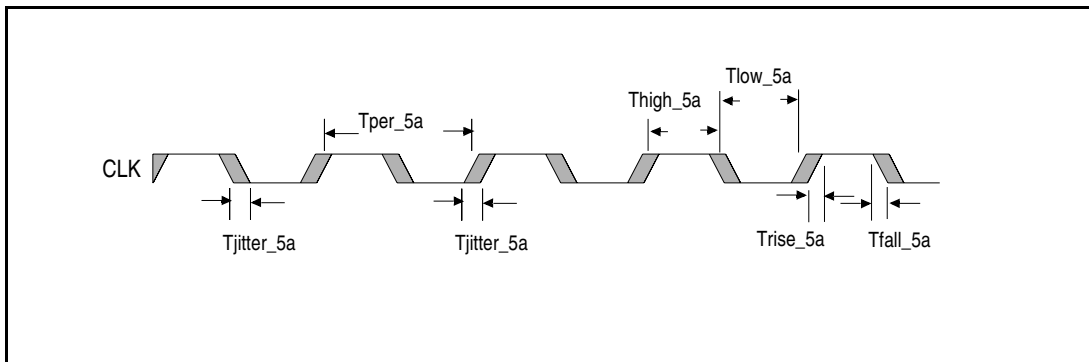

Figure 3 Clock Parameters Waveform

AC Timing Characteristics

(Values given below are based on systems running at recommended operating temperatures and supply voltages, shown in Tables 15 and 16.)

Signal	Symbol	Reference Edge	266MHz		300MHz		350MHz		400MHz		Unit	Conditions	Timing Diagram Reference
			Min	Max	Min	Max	Min	Max	Min	Max			
Reset													
COLDRSTN ¹	Tpw_6a ²	none	OSC	—	OSC	—	OSC	—	OSC	—	ms	Cold reset	See Figures 4 and 5.
	Trise_6a	none	—	5.0	—	5.0	—	5.0	—	5.0	ns	Cold reset	
RSTN ³ (input)	Tpw_6b ²	none	2(CLK)	—	2(CLK)	—	2(CLK)	—	2(CLK)	—	ns	Warm reset	
RSTN ³ (output)	Tdo_6c	COLDRSTN falling	—	15.0	—	15.0	—	15.0	—	15.0	ns	Cold reset	
MADDR[15:0] (boot vector)	Tdz_6d ²	COLDRSTN falling	—	30.0	—	30.0	—	30.0	—	30.0	ns	Cold reset	
	Tdz_6d ²	RSTN falling	—	5(CLK)	—	5(CLK)	—	5(CLK)	—	5(CLK)	ns	Warm reset	
	Tzd_6d ²	RSTN rising	2(CLK)	—	2(CLK)	—	2(CLK)	—	2(CLK)	—	ns	Warm reset	

Table 6 Reset and System AC Timing Characteristics

¹ The COLDRSTN minimum pulse width is the oscillator stabilization time (OSC) with V_{CC} stable.

² The values for this symbol were determined by calculation, not by testing.

³ RSTN is a bidirectional signal. It is treated as an asynchronous input.

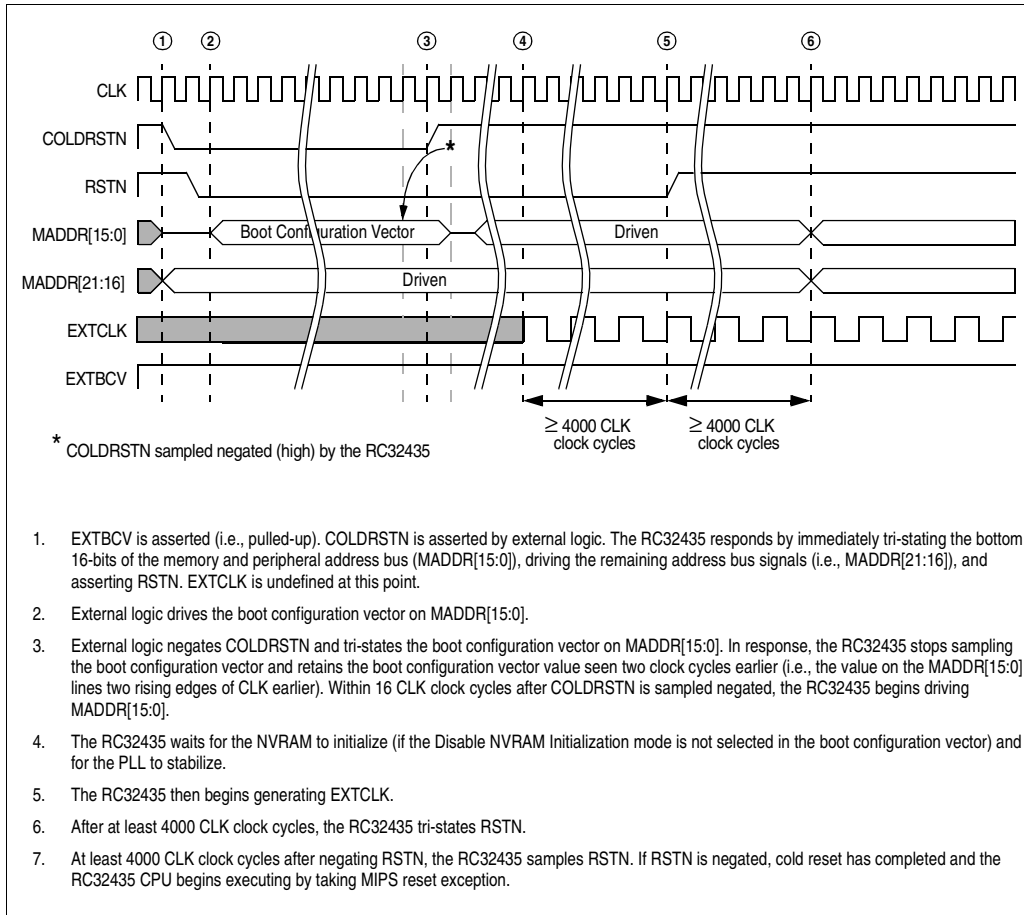

Figure 4 COLD Reset Operation with External Boot Configuration Vector AC Timing Waveform

Note: For a diagram showing the COLD Reset Operation with Internal Boot Configuration Vector, see Figure 3.6 in the RC32435 User Reference Manual.

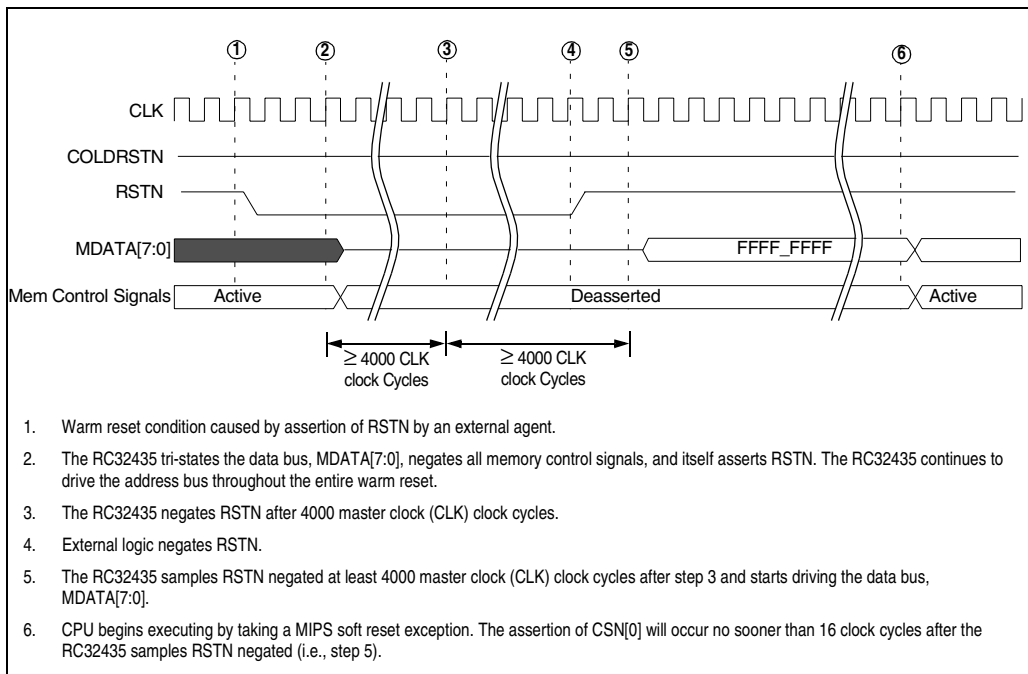

Figure 5 Externally Initiated Warm Reset AC Timing Waveform

Signal	Symbol	Reference Edge	266MHz		300MHz		350MHz		400MHz		Unit	Timing Diagram Reference
			Min	Max	Min	Max	Min	Max	Min	Max		
Memory Bus - DDR Access												
DDRDATA[15:0]	Tskew_7g	DDRQStx	0	0.9	0	0.8 ¹	0	0.7	0.0	0.6	ns	See Figures 6 and 7.
	Tdo_7k ²		1.2	1.9	1.0	1.7	0.7	1.5	0.5	1.4	ns	
DDRDM[1:0]	Tdo_7l	DDRQStx	1.2	1.9	1.0	1.7	0.7	1.5	0.5	1.4	ns	
DDRQStx[1:0]	Tdo_7i	DDRCKP	-0.75	0.75	-0.75	0.75	-0.7	0.7	-0.7	0.7	ns	
DDRADDR[13:0], DDRBA[1:0], DDRCASN, DDRCKE, DDRCASN, DDRRASN, DDRWEN	Tdo_7m	DDRCKP	1.0	4.0	1.0	4.3	1.0	4.0	1.0	4.0	ns	

Table 7 DDR SDRAM Timing Characteristics

¹. Meets DDR timing requirements for 150MHz clock rate DDR SDRAMs with 300 ps remaining margin to compensate for PCB propagation mismatches, which is adequate to guarantee functional timing, provided the RC32435 DDR layout guidelines are adhered to.

². Setup times are calculated as applicable clock period - Tdo max. For example, if the DDR is running at 266MHz, it uses a 133MHz input clock. The period for a 133MHz clock is 7.5ns. If the Tdo max value is 4.6ns, the T_{IS} parameter is 7.5ns minus 4.6ns = 2.9ns. The DDR spec for this parameter is 1ns, so there is 1.9ns of slack left over for board propagation. Calculations for T_{DS} are similar, but since this parameter is taken relative to the DDRDQS signals, which are referenced on both edges, the effective period with a 133MHz input clock is only 3.75ns. So, if the max Tdo is 1.9ns, we have 3.75ns minus 1.9ns = 1.85ns for T_{DS}. The DDR data sheet specs a value of 0.5ns for 266MHz, so this leaves 1.35ns slack for board propagation delays.

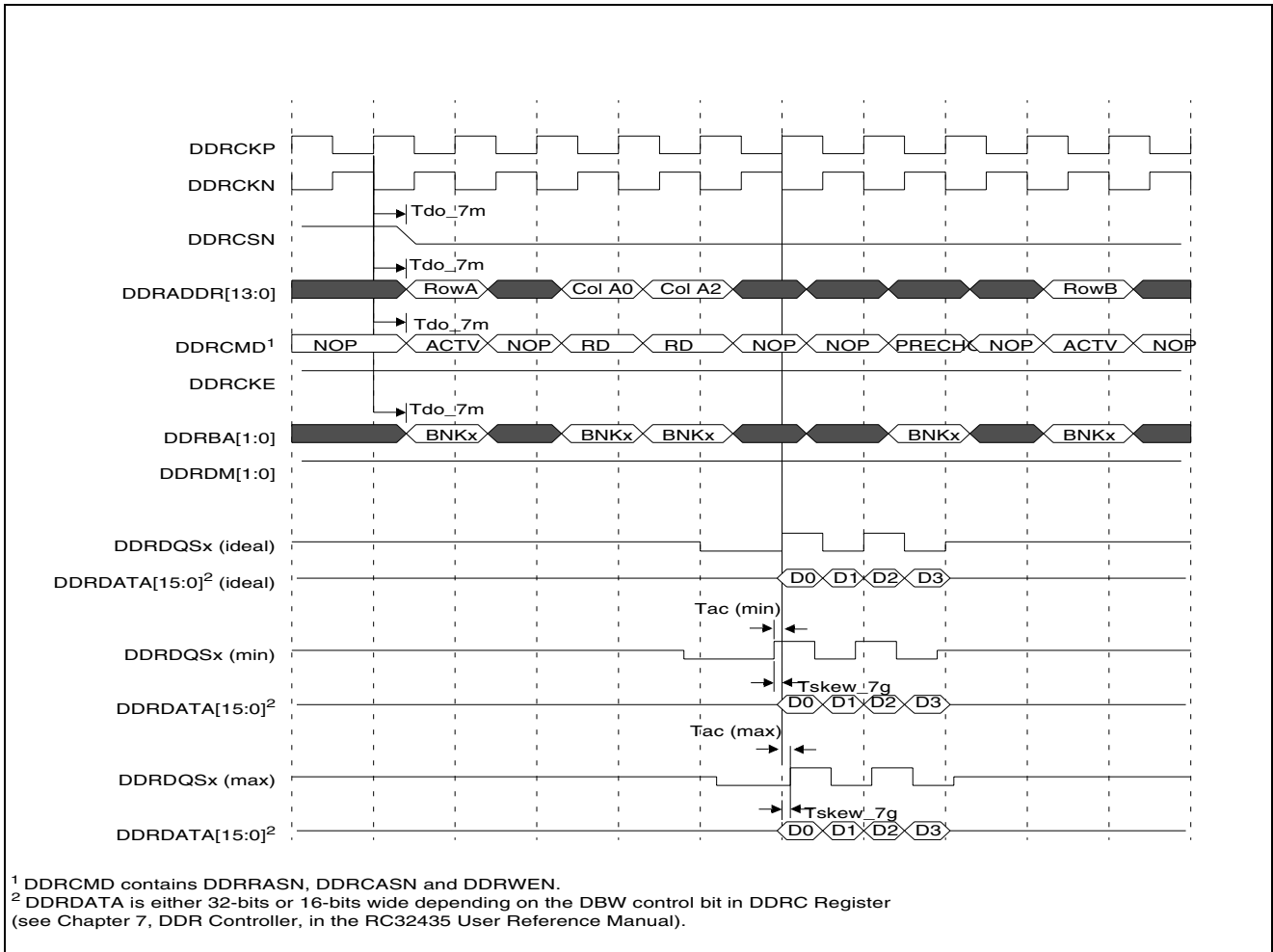

Figure 6 DDR SDRAM AC Timing Waveform - SDRAM Read Access

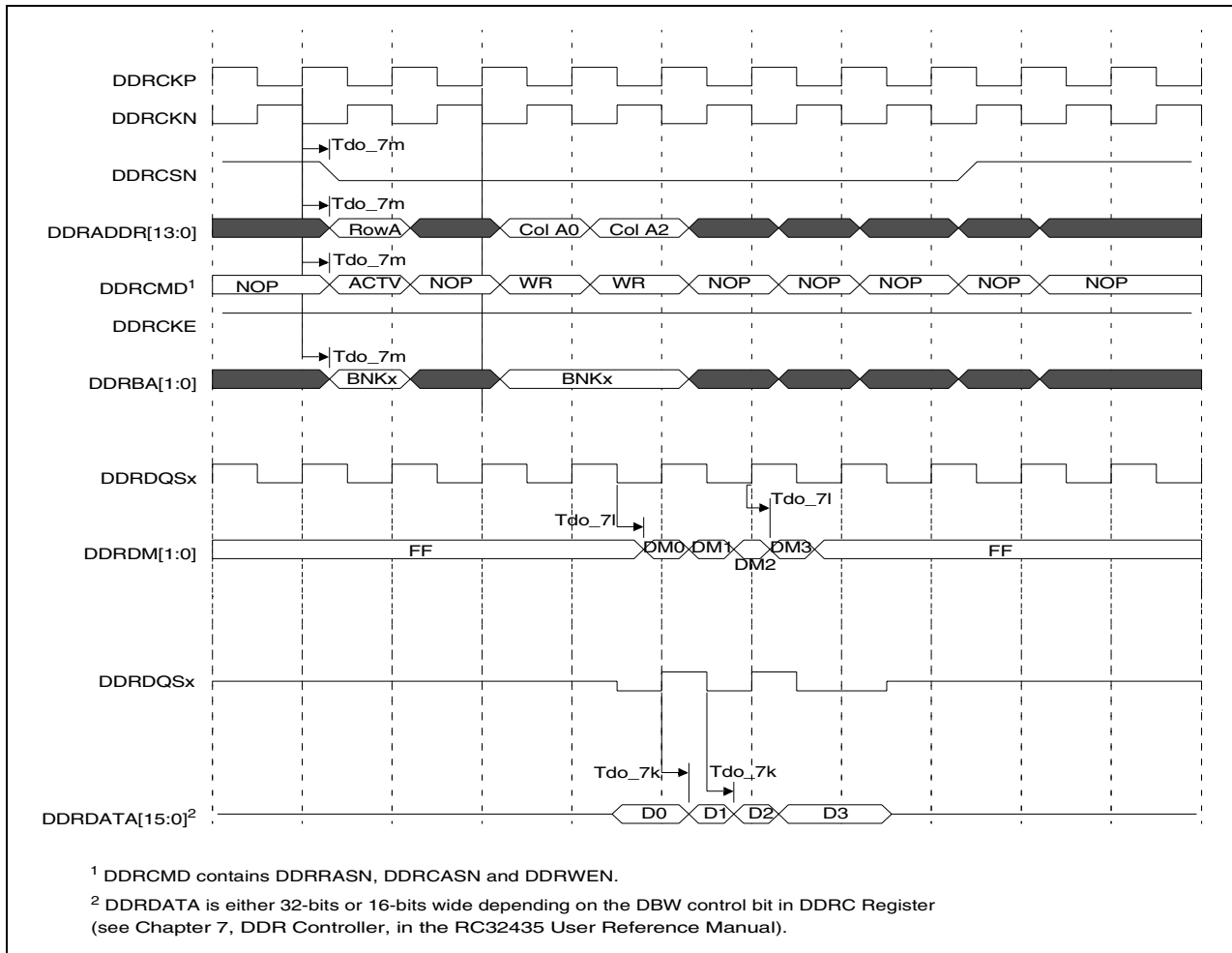

Figure 7 DDR SDRAM Timing Waveform — Write Access

Signal	Symbol	Reference Edge	266MHz		300MHz		350MHz		400MHz		Unit	Condi-tions	Timing Diagram Reference
			Min	Max	Min	Max	Min	Max	Min	Max			
Memory and Peripheral Bus¹													See Figures 8 and 9.
MADDR[21:0]	Tdo_8a	EXTCLK rising	0.4	4.5	0.4	4.5	0.4	4.5	0.4	4.5	ns		
	Tdz_8a ²		—	—	—	—	—	—	—	—	ns		
	Tzd_8a ²		—	—	—	—	—	—	—	—	ns		
MADDR[25:22]	Tdo_8b	EXTCLK rising	0.4	4.5	0.4	4.5	0.4	4.5	0.4	4.5	ns		
	Tdz_8b ²		—	—	—	—	—	—	—	—	ns		
	Tzd_8b ²		—	—	—	—	—	—	—	—	ns		

Table 8 Memory and Peripheral Bus AC Timing Characteristics (Part 1 of 2)

Signal	Symbol	Reference Edge	266MHz		300MHz		350MHz		400MHz		Unit	Condi-tions	Timing Diagram Reference
			Min	Max	Min	Max	Min	Max	Min	Max			
MDATA[7:0]	Tsu_8c	EXTCLK rising	6.0	—	6.0	—	6.0	—	6.0	—	ns	See Figures 8 and 9 (cont.).	
	Thld_8c		0	—	0	—	0	—	0	—	ns		
	Tdo_8c		0.4	4.5	0.4	4.5	0.4	4.5	0.4	4.5	ns		
	Tdz_8c ²		0	0.5	0	0.5	0	0.5	0	0.5	ns		
	Tzd_8c ²		0.4	3.3	0.4	3.3	0.4	3.3	0.4	3.3	ns		
EXTCLK ³	Tper_8d	none	7.5	—	6.66	—	6.66	—	6.66	—	ns		
BDIRN	Tdo_8e	EXTCLK rising	0.4	3.8	0.4	3.8	0.4	3.8	0.4	3.8	ns		
	Tdz_8e ²		—	—	—	—	—	—	—	—	ns		
	Tzd_8e ²		—	—	—	—	—	—	—	—	ns		
BOEN	Tdo_8f	EXTCLK rising	0.4	3.8	0.4	3.8	0.4	3.8	0.4	3.8	ns		
	Tdz_8f ²		—	—	—	—	—	—	—	—	ns		
	Tzd_8f ²		—	—	—	—	—	—	—	—	ns		
WAITACKN ⁴	Tsu_8h	EXTCLK rising	6.5	—	6.5	—	6.5	—	6.5	—	ns		
	Thld_8h		0	—	0	—	0	—	0	—	ns		
	Tpw_8h ²	none	2(EXTCLK)	—	2(EXTCLK)	—	2(EXTCLK)	—	2(EXTCLK)	—	ns		
CSN[3:0]	Tdo_8i	EXTCLK rising	0.4	4.0	0.4	4.0	0.4	4.0	0.4	4.0	ns		
	Tdz_8i ²		—	—	—	—	—	—	—	—	ns		
	Tzd_8i ²		—	—	—	—	—	—	—	—	ns		
RWN	Tdo_8j	EXTCLK rising	0.4	3.8	0.4	3.8	0.4	3.8	0.4	3.8	ns		
	Tdz_8j ²		—	—	—	—	—	—	—	—	ns		
	Tzd_8j ²		—	—	—	—	—	—	—	—	ns		
OEN	Tdo_8k	EXTCLK rising	0.4	4.0	0.4	4.0	0.4	4.0	0.4	4.0	ns		
	Tdz_8k ²		—	—	—	—	—	—	—	—	ns		
	Tzd_8k ²		—	—	—	—	—	—	—	—	ns		
WEN	Tdo_8l	EXTCLK rising	0.4	3.7	0.4	3.7	0.4	3.7	0.4	3.7	ns		
	Tdz_8l ²		—	—	—	—	—	—	—	—	ns		
	Tzd_8l ²		—	—	—	—	—	—	—	—	ns		

Table 8 Memory and Peripheral Bus AC Timing Characteristics (Part 2 of 2)

¹: The RC32435 provides bus turnaround cycles to prevent bus contention when going from read to write, write to read, and during external bus ownership. For example, there are no cycles where an external device and the RC32435 are both driving. See Chapter 6, Device Controller, in the RC32435 User Reference Manual.

²: The values for this symbol were determined by calculation, not by testing.

³: The frequency of EXTCLK is programmable. See the External Clock Divider (MDATA[5:4]) description in Table 3 of this data sheet.

⁴: WAITACKN must meet the setup and hold times if it is synchronous or the minimum pulse width if it is asynchronous.

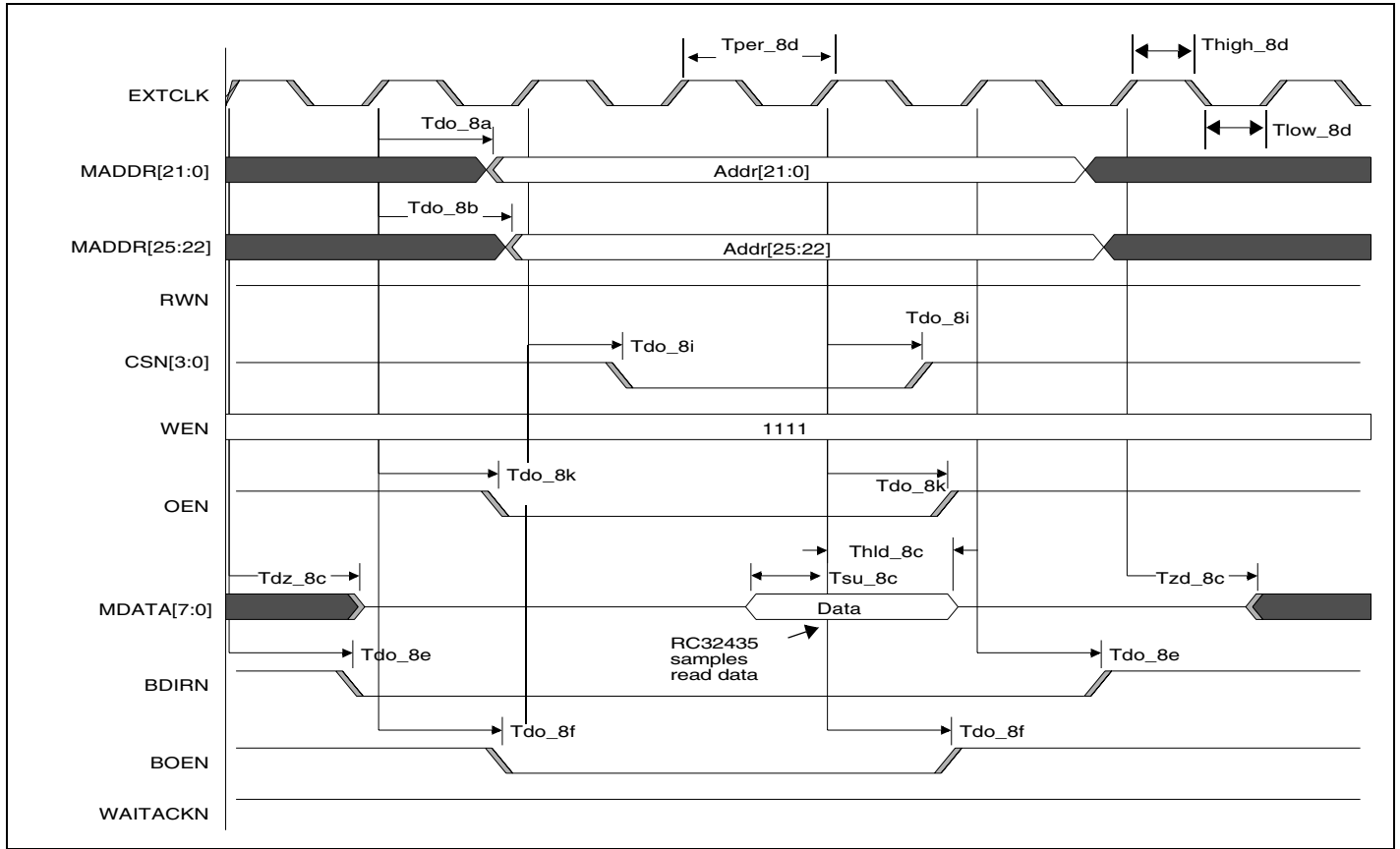

Figure 8 Memory and Peripheral Bus AC Timing Waveform — Read Access

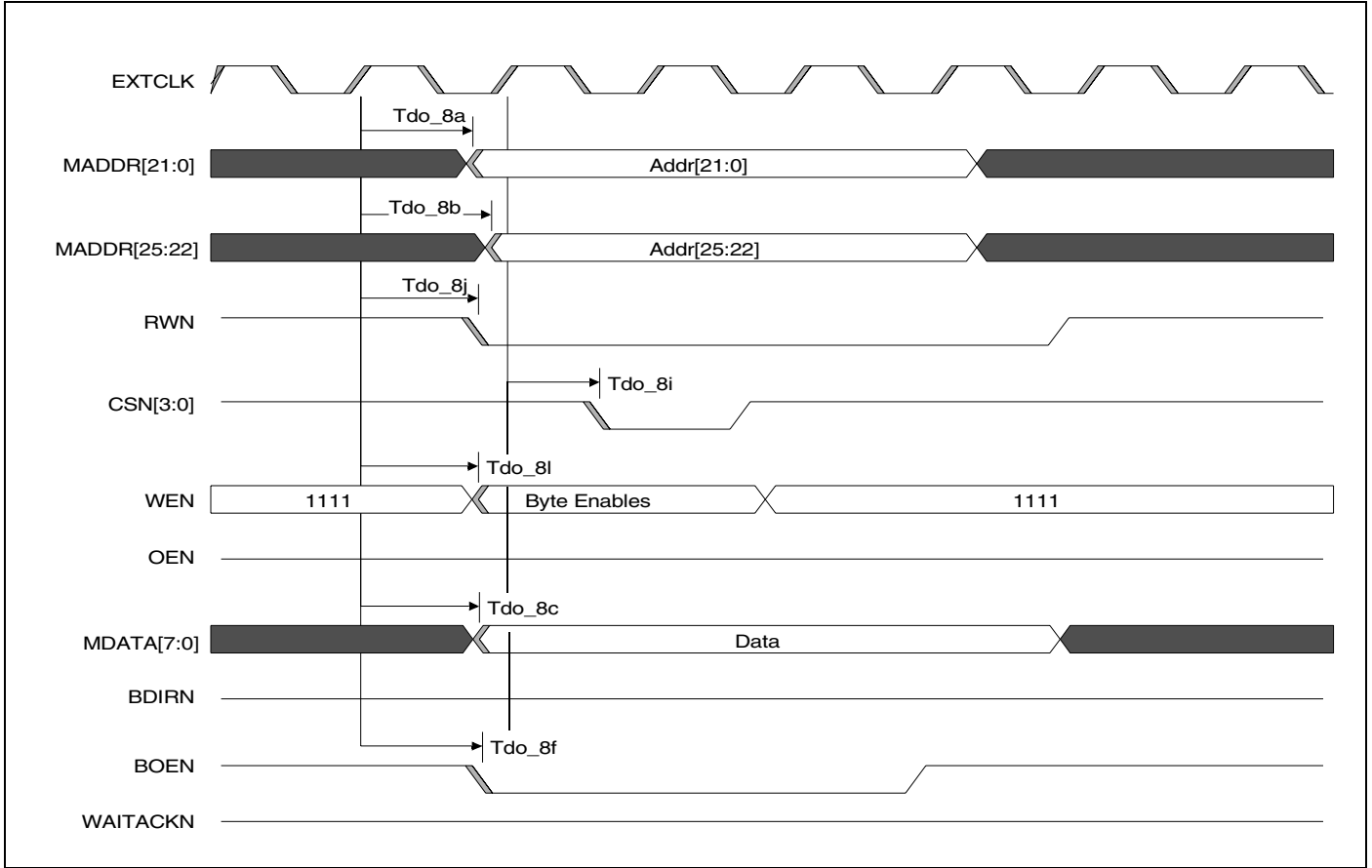

Figure 9 Memory and Peripheral Bus AC Timing Waveform — Write Access

Signal	Symbol	Reference Edge	266MHz		300MHz		350MHz		400MHz		Unit	Condi-tions	Timing Diagram Reference
			Min	Max	Min	Max	Min	Max	Min	Max			
Ethernet													
MIIMDC	Tper_9a	None	30.0	—	30.0	—	30.0	—	30.0	—	ns		See Figure 10.
	Thigh_9a, Tlow_9a		12.0	—	12.0	—	12.0	—	12.0	—	ns		
MIIMDIO	Tsu_9b	MIIMDC rising	10.0	—	10.0	—	10.0	—	10.0	—	ns		
	Thld_9b		0.0	—	0.0	—	0.0	—	0.0	—	ns		
	Tdo_9b ¹		10	300	10	300	10	300	10	300	ns		
Ethernet — MII Mode													
MIIRXCLK, MIITXCLK ²	Tper_9c	None	399.96	400.4	399.96	400.4	399.96	400.4	399.96	400.4	ns	10 Mbps	See Figure 10.
	Thigh_9c, Tlow_9c		140	260	140	260	140	260	140	260	ns		
	Trise_9c, Tfall_9c		—	3.0	—	3.0	—	3.0	—	3.0	ns		
MIIRXCLK, MIITXCLK ²	Tper_9d	None	39.9	40.0	39.9	40.0	39.9	40.0	39.9	40.0	ns	100 Mbps	
	Thigh_9d, Tlow_9d		14.0	26.0	14.0	26.0	14.0	26.0	14.0	26.0	ns		
	Trise_9d, Tfall_9d		—	2.0	—	2.0	—	2.0	—	2.0	ns		
MIIRXD[3:0], MIIRXDV, MIIRXER	Tsu_9e	MIIRXCLK rising	10.0	—	10.0	—	10.0	—	10.0	—	ns		
	Thld_9e		10.0	—	10.0	—	10.0	—	10.0	—	ns		
MIITXD[3:0], MIITXENP, MIITXER	Tdo_9f	MIITXCLK rising	0.0	25.0	0.0	25.0	0.0	25.0	0.0	25.0	ns		
Ethernet — RMII Mode													
RMIREFCLK	Tper_9i	None	19.9	20.1	19.9	20.1	19.9	20.1	19.9	20.1	ns		See Figure 10.
	Thigh_9i, Tlow_9i		7.0	13.0	7.0	13.0	7.0	13.0	7.0	13.0	ns		
RMIITXEN, RMIITXD[1:0]	Tdo_9j	MIIRXCLK rising	2.0	—	2.0	—	2.0	—	2.0	—	ns		
RMIICRSDV, RMIIRXER, RMIIRXD[1:0]	Tsu_9k		5.5	14.5	5.5	14.5	5.5	14.5	5.5	14.5	ns		

Table 9 Ethernet AC Timing Characteristics

¹. The values for this symbol were determined by calculation, not by testing.

². The ethernet clock (MIIRXCLK and MIITXCLK) frequency must be equal to or less than 1/2 ICLK (MIIRXCLK and MIITXCLK <= 1/2(ICLK)).