



Chipsmall Limited consists of a professional team with an average of over 10 year of expertise in the distribution of electronic components. Based in Hongkong, we have already established firm and mutual-benefit business relationships with customers from,Europe,America and south Asia,supplying obsolete and hard-to-find components to meet their specific needs.

With the principle of “Quality Parts,Customers Priority,Honest Operation,and Considerate Service”,our business mainly focus on the distribution of electronic components. Line cards we deal with include Microchip,ALPS,ROHM,Xilinx,Pulse,ON,Everlight and Freescale. Main products comprise IC,Modules,Potentiometer,IC Socket,Relay,Connector.Our parts cover such applications as commercial,industrial, and automotives areas.

We are looking forward to setting up business relationship with you and hope to provide you with the best service and solution. Let us make a better world for our industry!



## Contact us

Tel: +86-755-8981 8866 Fax: +86-755-8427 6832

Email & Skype: info@chipsmall.com Web: www.chipsmall.com

Address: A1208, Overseas Decoration Building, #122 Zhenhua RD., Futian, Shenzhen, China



THIS DRAWING IS UNPUBLISHED. RELEASED FOR PUBLICATION  
 © COPYRIGHT - BY - TE CONNECTIVITY ALL RIGHTS RESERVED.

LOC	DIST	REVISIONS					
-	-	P	LTR	DESCRIPTION	DATE	DWN	APVD
		A		INITIAL RELEASE	21FEB2012	ZHJ	E.K
		B		ADD 4P/7P PRODUCT	28MAY2013	HJ.Z	YH.M

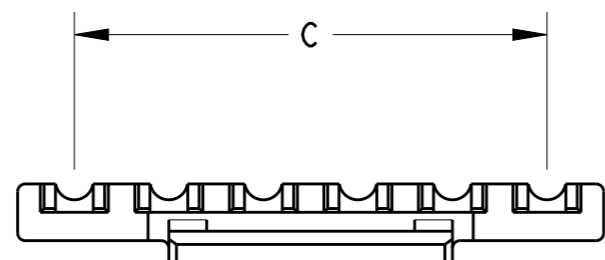
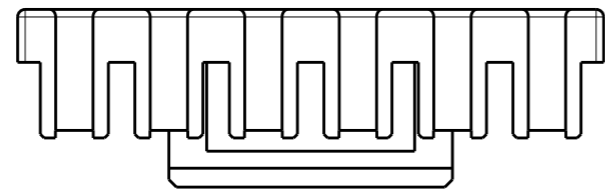
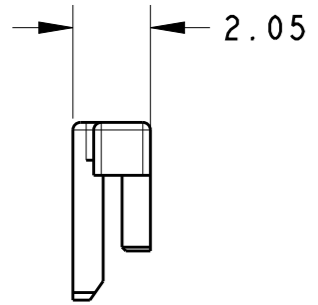
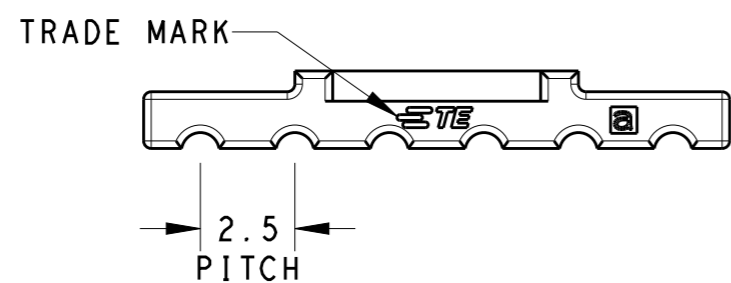
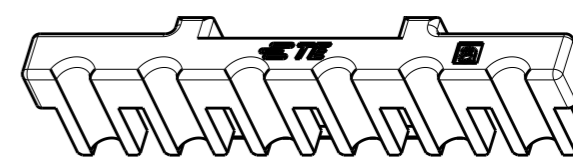
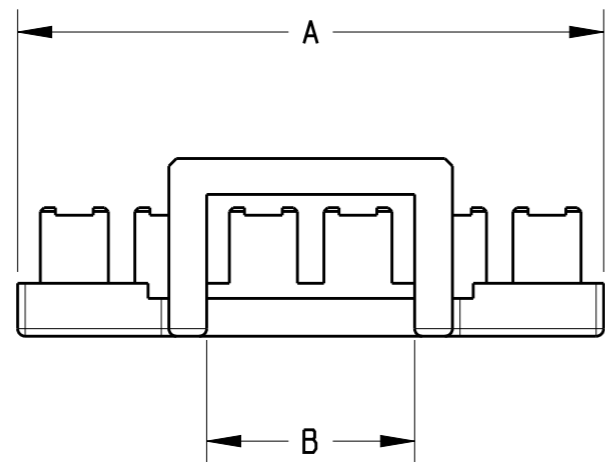

\*The part is assembled with plug housing: X-1971793-X

17.5	8.4	20.5	8	8-1971794-1
15	8.4	18	7	7-1971794-1
12.5	5.5	15.5	6	6-1971794-1
10	3.3	13	5	5-1971794-1
7.5	3.7	10.5	4	4-1971794-1
5	2.5	8	3	3-1971794-1
2.5	2.4	5.5	2	2-1971794-1
C	B	A	POS	P/N

THIS DRAWING IS A CONTROLLED DOCUMENT.		DWN HJ.M 28MAY2013	 TE Connectivity	
DIMENSIONS: mm		CHK HJ.M 28MAY2013		
TOLERANCES UNLESS OTHERWISE SPECIFIED:		APVD HJ.M 28MAY2013	NAME TPA, 2.5 PITCH NEXT GENERATION GI CONNECTOR	
0 PLC ±- 1 PLC ±0.3 2 PLC ±0.13 3 PLC ±0.013 4 PLC ±0.0001 ANGLES ±-		PRODUCT SPEC 108-106077	RESTRICTED TO	
MATERIAL PA66 GF		FINISH -	SIZE A3	CAGE CODE -
		WEIGHT -	DRAWING NO C-1971794	
		Customer Drawing	SCALE /	SHEET 1 OF 1
				REV B