



Chipsmall Limited consists of a professional team with an average of over 10 year of expertise in the distribution of electronic components. Based in Hongkong, we have already established firm and mutual-benefit business relationships with customers from,Europe,America and south Asia,supplying obsolete and hard-to-find components to meet their specific needs.

With the principle of "Quality Parts,Customers Priority,Honest Operation,and Considerate Service",our business mainly focus on the distribution of electronic components. Line cards we deal with include Microchip,ALPS,ROHM,Xilinx,Pulse,ON,Everlight and Freescale. Main products comprise IC,Modules,Potentiometer,IC Socket,Relay,Connector.Our parts cover such applications as commercial,industrial, and automotives areas.

We are looking forward to setting up business relationship with you and hope to provide you with the best service and solution. Let us make a better world for our industry!



Contact us

Tel: +86-755-8981 8866 Fax: +86-755-8427 6832

Email & Skype: info@chipsmall.com Web: www.chipsmall.com

Address: A1208, Overseas Decoration Building, #122 Zhenhua RD., Futian, Shenzhen, China



PART NO.	ME-302L WIRE	SCALE	1: 1
DESCRIPTION	SJT#16*3C 60C	UNIT:	mm
DWG No.	800-1603-0-SJT0-BL-00100		

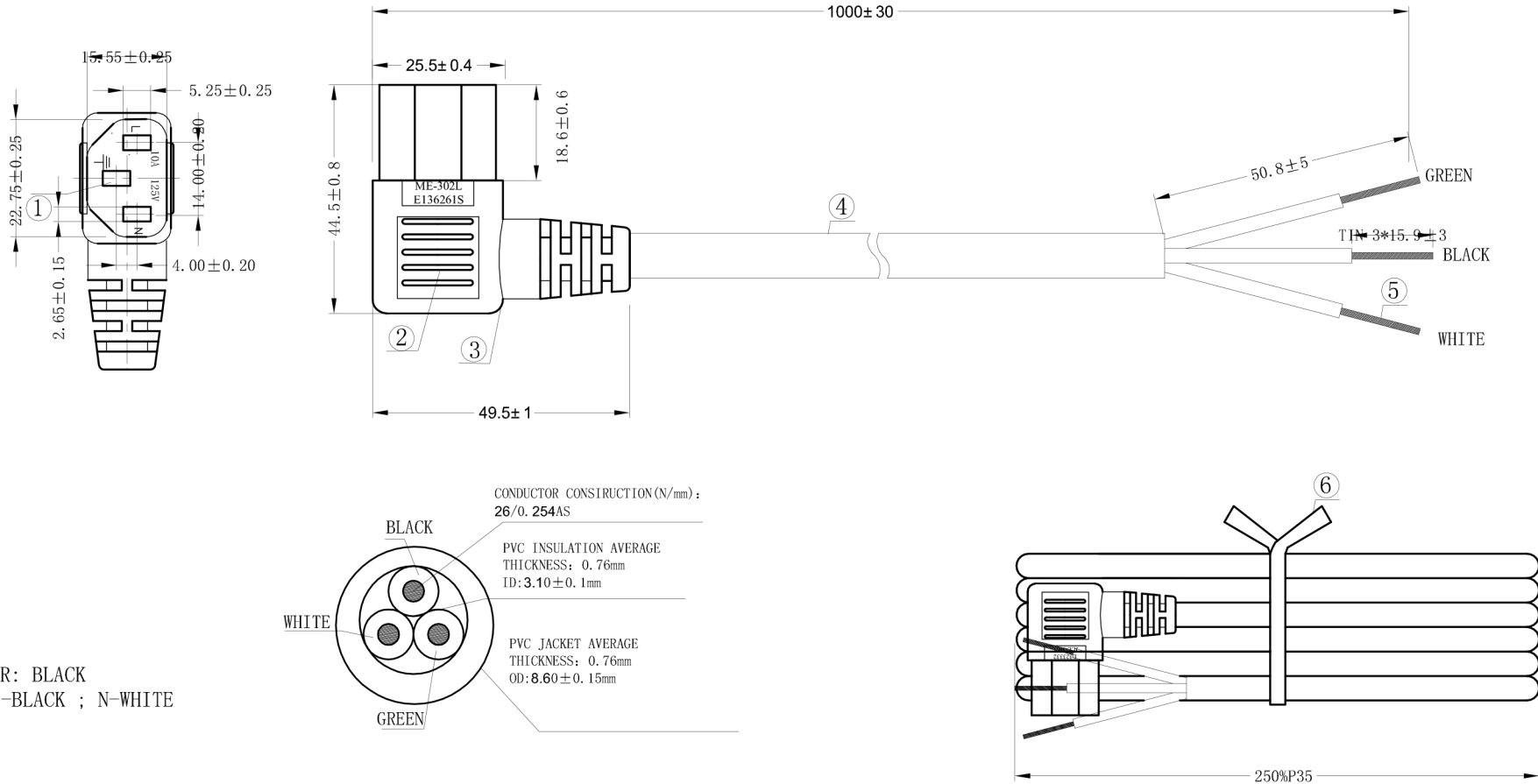

NOTES:

- 1) JACKET COLOR: BLACK
- 2). E-GREEN; L-BLACK ; N-WHITE

TESTING:

- 1) 100% OPEN & SHORT TESTING
- 2) INSULATION RESISTANCE: 100M ohm(min)
- 3) VOLTAGE: DC500V/1min
- 4) ROHS COMPLIANT

Printing the contents of wire The use of printing ink replenish Wire

E243929 (UL) SJT 3×16AWG(1.31mm²) VW-1 60°C 300V CSA 228191 SJT 3×16AWG(1.31mm²) FT2 60°C 300V -LF-

REV	DATE	DESCRIPTION	SYMBOL
DRAWED/DATE		CHECKED/DATE	
GONG/10.11.5		ZHUYING/10.11.6	

NO.	SPECIFICATION	COLOUR	MATERIAL	AMOUNT
①	Play home terminal 98740	Silver	Cu	3P
②	Model aircraft 8745AND	WHITE	PBT	1PCS
③	Mother Play ME-302L	BLACK	PVC Cu	1PCS
④	Wire SJT 16AWG/3C 60°	BLACK	PVC Cu	1PCS
⑤	Tin	Silver	Article tin	3PCS
⑥	Ties	BLACK		1PCS