



Chipsmall Limited consists of a professional team with an average of over 10 year of expertise in the distribution of electronic components. Based in Hongkong, we have already established firm and mutual-benefit business relationships with customers from,Europe,America and south Asia,supplying obsolete and hard-to-find components to meet their specific needs.

With the principle of "Quality Parts,Customers Priority,Honest Operation,and Considerate Service",our business mainly focus on the distribution of electronic components. Line cards we deal with include Microchip,ALPS,ROHM,Xilinx,Pulse,ON,Everlight and Freescale. Main products comprise IC,Modules,Potentiometer,IC Socket,Relay,Connector.Our parts cover such applications as commercial,industrial, and automotives areas.

We are looking forward to setting up business relationship with you and hope to provide you with the best service and solution. Let us make a better world for our industry!



Contact us

Tel: +86-755-8981 8866 Fax: +86-755-8427 6832

Email & Skype: info@chipsmall.com Web: www.chipsmall.com

Address: A1208, Overseas Decoration Building, #122 Zhenhua RD., Futian, Shenzhen, China



THIS DOCUMENT IS THE PROPERTY OF
KEYSTONE ELECTRONICS CORP. AND
SHALL NOT BE REPRODUCED, DISTRIBUTED
OR USED AS A BASIS FOR MANUFACTURE
WITHOUT PRIOR WRITTEN PERMISSION
FROM KEYSTONE ELECTRONICS CORP.

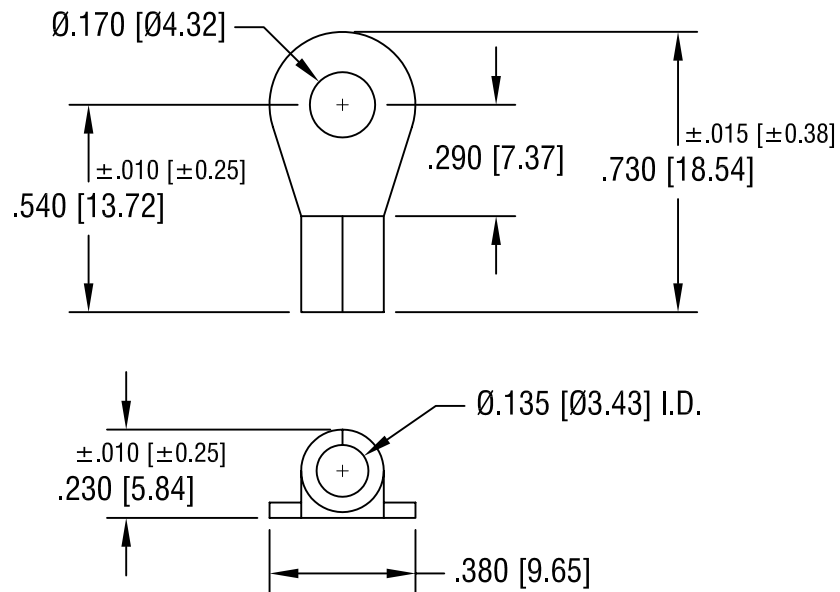

NOTE:

1. ACCOMMODATES WIRE RANGE 12/10 AWG

KEYSTONE ELECTRONICS CORP.			
ASTORIA, N.Y. 11105-2017			
PART NAME			
RING TONGUE TERMINAL			
MATERIAL			
.040 [1.02] TH'K COPPER			
FINISH		DRN BY	DATE
TIN PLATE		BOONE	10.17.07
		APP'D	SCALE
		LN	2X
TOLERANCES	INCH [MM]	CODE	DWG NO.
DECIMAL	$\pm .005$ [± 0.15]	C/M	8207
ANGULAR	$\pm 1^\circ$		
UNLESS OTHERWISE SPECIFIED			

DATE	DESCRIPTION	REV.