



Chipsmall Limited consists of a professional team with an average of over 10 year of expertise in the distribution of electronic components. Based in Hongkong, we have already established firm and mutual-benefit business relationships with customers from,Europe,America and south Asia,supplying obsolete and hard-to-find components to meet their specific needs.

With the principle of "Quality Parts,Customers Priority,Honest Operation,and Considerate Service",our business mainly focus on the distribution of electronic components. Line cards we deal with include Microchip,ALPS,ROHM,Xilinx,Pulse,ON,Everlight and Freescale. Main products comprise IC,Modules,Potentiometer,IC Socket,Relay,Connector.Our parts cover such applications as commercial,industrial, and automotives areas.

We are looking forward to setting up business relationship with you and hope to provide you with the best service and solution. Let us make a better world for our industry!



Contact us

Tel: +86-755-8981 8866 Fax: +86-755-8427 6832

Email & Skype: info@chipsmall.com Web: www.chipsmall.com

Address: A1208, Overseas Decoration Building, #122 Zhenhua RD., Futian, Shenzhen, China



0.5 Nm ovoid 3.9 Watts 3.9 W Part number made to order



- Torque rating of gearboxes : 0.5 Nm, high-performance plastic gears
- Motors : nominal power 3 W, interference suppression for standard stocked products
- Wide speed range : 0.3 to 430 rpm
- Optional encoder built into the motor

Part numbers

	Type	Type	Voltage	Standard speed (rpm)	Output speed (rpm)	Ratios (i)
82861022	3.9 W	828610	24 V	4300	8,6	500

Specifications

General characteristics

Motor	828600
Gearbox	810210
Maximum permitted torque from gearmotor under continuous conditions for 1 million turns (Nm)	0.5
Axial load static (daN)	1
Radial load static (daN)	8
Max. output power (W)	3,9
Nominal output (W)	3
Gearbox case temperature rise (°C)	50
Weight (g)	160

Made to order products, available on request

Motors :

- Other supply voltages
- Motor with 2 ball bearings
- Shaft lengths at front and/or rear
- Lead outputs or radial tag terminals
- Special interference suppression
- Encoder : 5 pulses/rev

Gearboxes :

- Special shaft
- Ball bearing
- Special greasing
- Torque limiter F
- Gearbox fixing M3
- Other speeds

Dimensions (mm)

828610

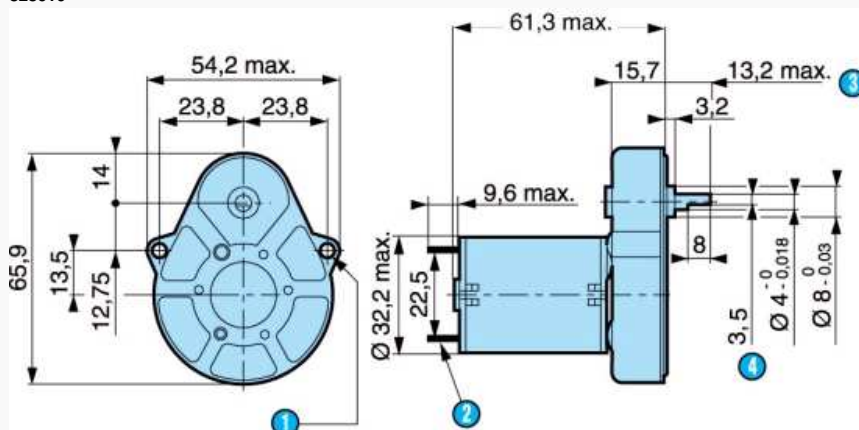

N°	Legend

①	2 fixing holes $\varnothing 3.2$
②	2 standard tags NFC 20-120, series 2.8 x 0.5 mm
③	Shaft pushed-in
④	3.5 across flats

Dimensions (mm)

Shaft 70999421
SP1295.10

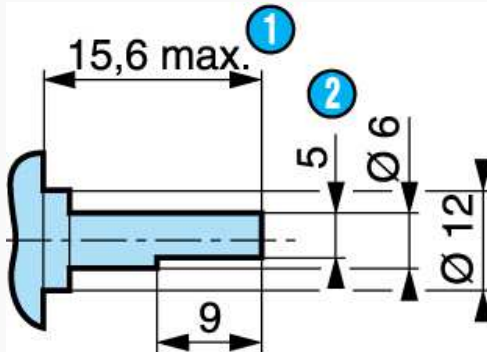

N°	Legend
①	Shaft pushed-in
②	5 across flats

Dimensions (mm)

Shaft 79200779

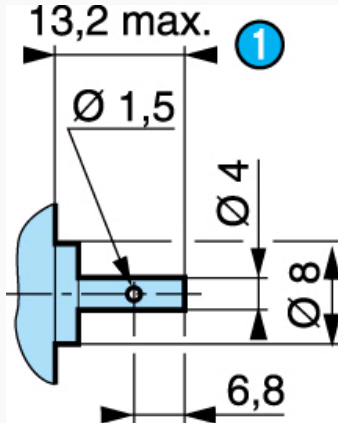

N°	Legend
①	Shaft pushed-in

Dimensions (mm)

Shaft 79200967

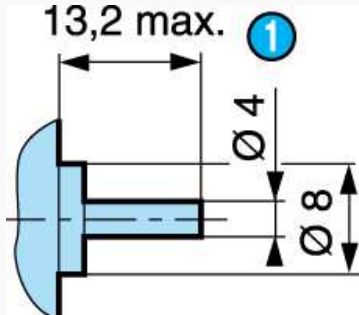

N°	Legend
----	--------



Curves

Curve : torque/nominal speed 828610

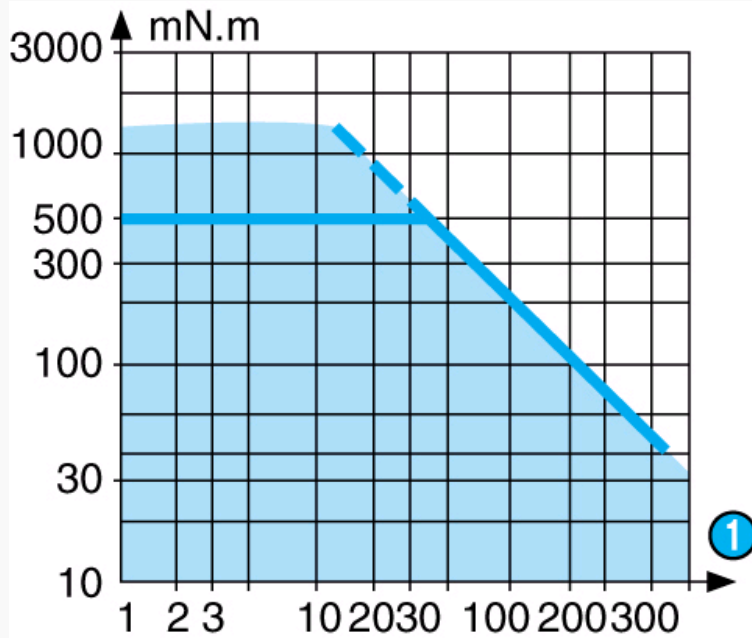

N°	Legend
1	rpm

Product adaptations



- Special supply voltage
- Lead output
- 1 or 5 pulse encoder
- Special connectors
- Special shaft
- Special reduction ratio
- Special materials for gears
- Special ball bearings
- Special adaptor plate
- EMC filter
- More than 200 reduction ratios available