



Chipsmall Limited consists of a professional team with an average of over 10 year of expertise in the distribution of electronic components. Based in Hongkong, we have already established firm and mutual-benefit business relationships with customers from,Europe,America and south Asia,supplying obsolete and hard-to-find components to meet their specific needs.

With the principle of “Quality Parts,Customers Priority,Honest Operation,and Considerate Service”,our business mainly focus on the distribution of electronic components. Line cards we deal with include Microchip,ALPS,ROHM,Xilinx,Pulse,ON,Everlight and Freescale. Main products comprise IC,Modules,Potentiometer,IC Socket,Relay,Connector.Our parts cover such applications as commercial,industrial, and automotives areas.

We are looking forward to setting up business relationship with you and hope to provide you with the best service and solution. Let us make a better world for our industry!



Contact us

Tel: +86-755-8981 8866 Fax: +86-755-8427 6832

Email & Skype: info@chipsmall.com Web: www.chipsmall.com

Address: A1208, Overseas Decoration Building, #122 Zhenhua RD., Futian, Shenzhen, China



INTERCONNECTS

SERIES 830, 831, 832, 833 • 2mm GRID HEADERS AND SOCKETS • SINGLE AND DOUBLE ROW STRIPS

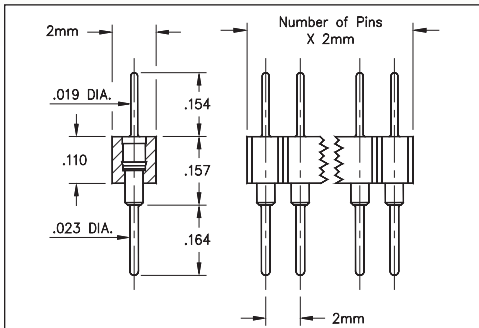

FIG. 1

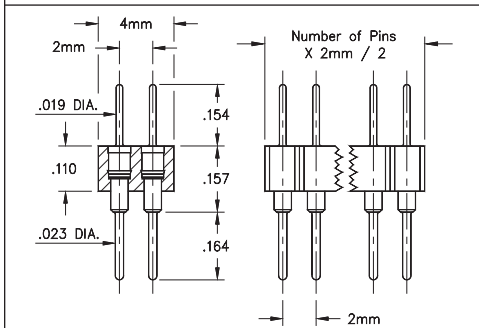

FIG. 2

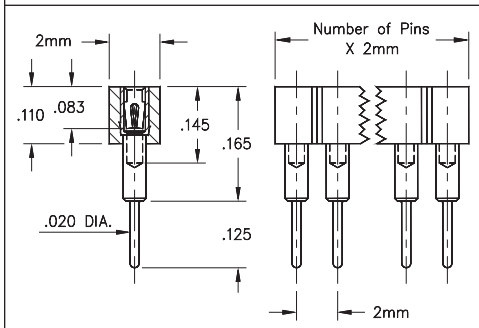

FIG. 3

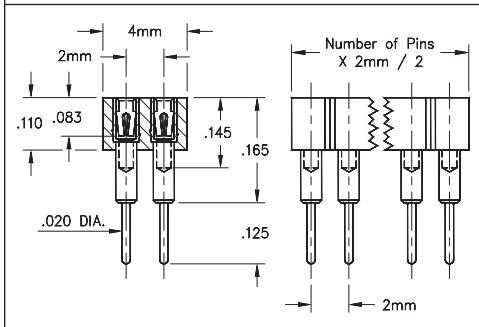
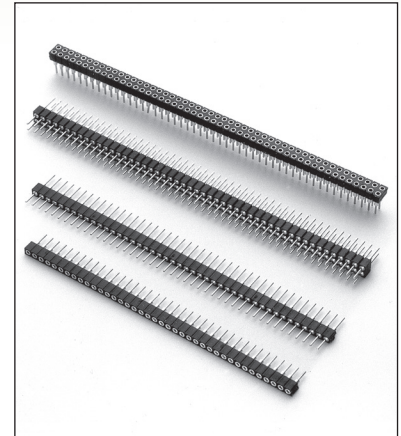

FIG. 4

- Series 830 single & double row interconnects have 2mm pin spacing and permit board stacking as low as .322"
- Pin headers (830 & 832 series) use MM #5012 pins. See page 208 for details
- Sockets (831 & 833 series) use MM #1802 receptacles and accept pin diameters from .015"-.025". See page 169 for details
- Contact is rated at 3 amps
- Insulators are high temperature thermoplastic, suitable for all soldering operations



ORDERING INFORMATION





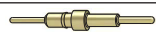

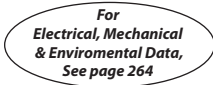



FIG. 1	Series 830...001	Single Row Pin Header		
	830-XX-0	-10-001000	Specify number of pins 01-50	
FIG. 2	Series 832...001	Double Row Pin Header		
	832-XX-	-10-001000	Specify number of pins 004-100	
  				
SPECIFY PLATING CODE XX=		10 	90	40 
Pin Plating 		10 μ" Au	200 μ" Sn/Pb	200 μ" Sn

FIG. 3	Series 831...001	Single Row Socket			
	831-XX-0	-10-001000	Specify number of pins 01-50		
FIG. 4	Series 833...001	Double Row Socket			
	833-XX-	-10-001000	Specify number of pins 004-100		
  					
SPECIFY PLATING CODE XX=		91	93	41 	43 
Sleeve (Pin) 		200 μ" Sn/Pb	200 μ" Sn/Pb	200 μ" Sn	200 μ" Sn
Contact (Clip) 		10 μ" Au	30 μ" Au	10 μ" Au	30 μ" Au

