



Chipsmall Limited consists of a professional team with an average of over 10 year of expertise in the distribution of electronic components. Based in Hongkong, we have already established firm and mutual-benefit business relationships with customers from,Europe,America and south Asia,supplying obsolete and hard-to-find components to meet their specific needs.

With the principle of “Quality Parts,Customers Priority,Honest Operation,and Considerate Service”,our business mainly focus on the distribution of electronic components. Line cards we deal with include Microchip,ALPS,ROHM,Xilinx,Pulse,ON,Everlight and Freescale. Main products comprise IC,Modules,Potentiometer,IC Socket,Relay,Connector.Our parts cover such applications as commercial,industrial, and automotives areas.

We are looking forward to setting up business relationship with you and hope to provide you with the best service and solution. Let us make a better world for our industry!



## Contact us

Tel: +86-755-8981 8866 Fax: +86-755-8427 6832

Email & Skype: info@chipsmall.com Web: www.chipsmall.com

Address: A1208, Overseas Decoration Building, #122 Zhenhua RD., Futian, Shenzhen, China





**3M**

# SC Connectors and Accessories

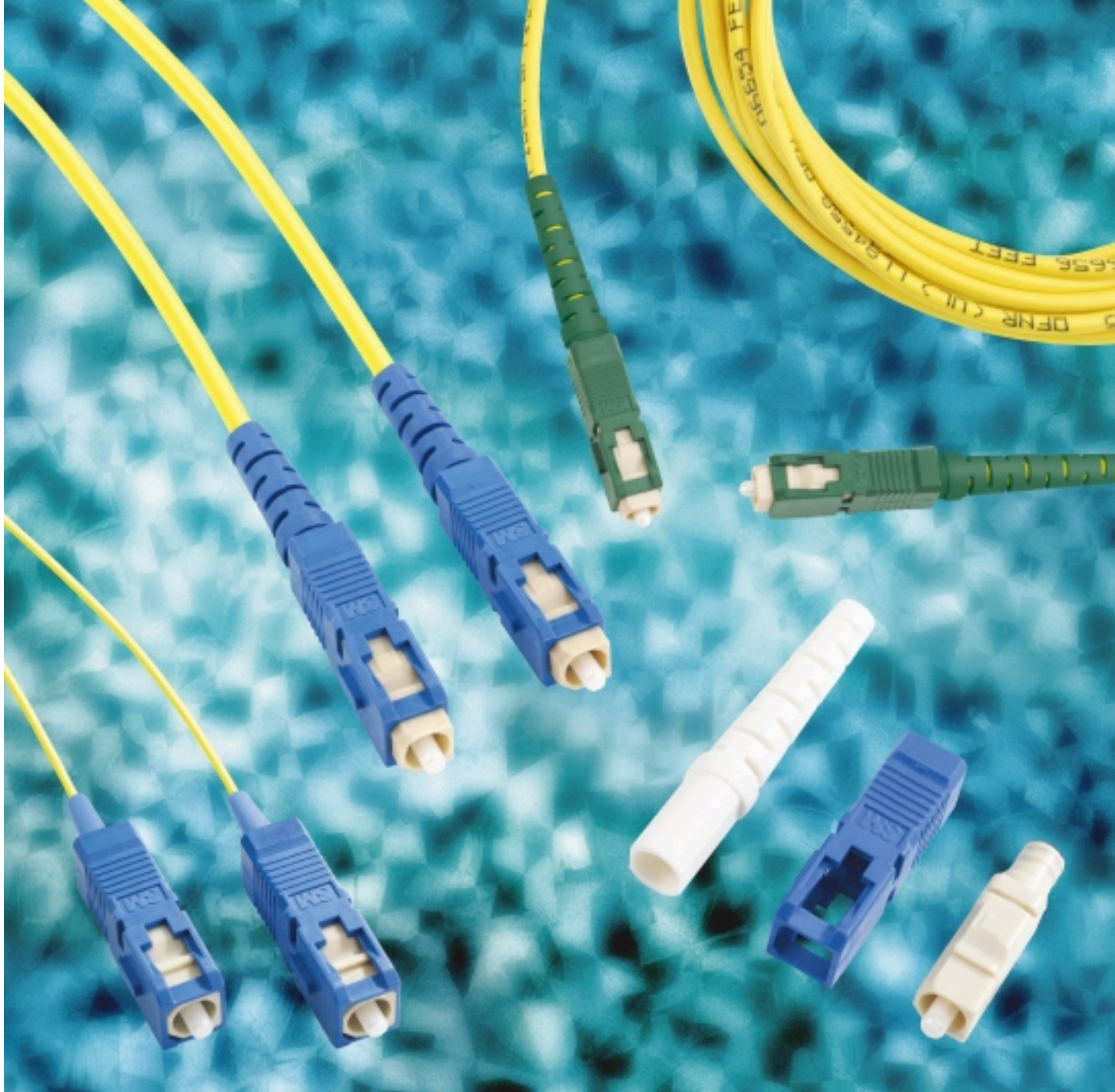

# A Family of SC Connectors

**3M offers a full line of SC Connectors, including Epoxy, Hot Melt, Crimplok™, Low EMI, and Angled Polished Connectors, to meet all your connector needs. 3M has simplified the design of the SC Connector to enhance performance and cable retention and provide readily field mountable connectors.**

The connector is fully compliant with NTT, JIS, ISO/IEC and TIA/EIA component and ISO/IEC, CENELEC, ANSI, TIA/EIA-568A and BICSI system and cabling level standards. The 3M™ SC Connector has a rectangular push-pull coupling mechanism for easy insertion and high repeatability. The zirconia ceramic ferrule, with a proprietary PC finish assures low attenuation and can now minimize reflected power to -55 dB on factory polished single-mode cable assemblies.

The SC Connector is designed for the most advanced fiber optic systems requiring exceptional stability, low reflections (single-mode) and high density. This versatile connector offers easy installation in both long and short transmission lines, subscriber networks or premises environments.

The 3M Field-Mountable Connector maximizes termination yield through ease of mounting and a high performance polishing procedure. The extended ferrule collar assembly ensures that the adhesive encapsulates the end of the buffer without wicking or spreading. The four-piece design (connector, shell, crimp ring and boot) is mounted using the same simple process used for other 3M connectors.

The 3M SC Low EMI Connector has unique material, which minimizes electromagnetic interference for routers and switches and test bed applications.

The SC Epoxy and Low EMI Connectors are available in single-mode

and multimode utilizing epoxy adhesive. The SC Hot Melt Connector, available in single-mode and multimode, is preloaded with Hot-Melt adhesive, enabling a field termination in less than two minutes for multiple terminations.

The SC Crimplok™ Connector, also available in both single-mode and multimode, combines the speed of non-adhesive connectors with the performance characteristics of epoxy and hot melt connectors.

The SC Hot Melt and Crimplok Connectors are specifically intended for ease of termination in local area network and meet requirements of system and cabling level standards.

3M also offers the following to help ensure you meet any and all of your connector needs.

A variety of distribution units are available to accommodate the SC design.

For high cable assembly applications, try the 3M Fiber Optic Bulk Pack. Consisting of 1,000 connectors, boots and accessories, the 3M Bulk Pack dramatically decreases assembly time and cost.

3M offers a standard 1.5" boot, as well as shorter 1.1" boots for high density, confined space applications.

2.0 mm boots for smaller jacket sizes ranging from 1.6 mm to 2.0 mm and buffer boots for 900 μm buffered fiber are also available.



SC Connector

2

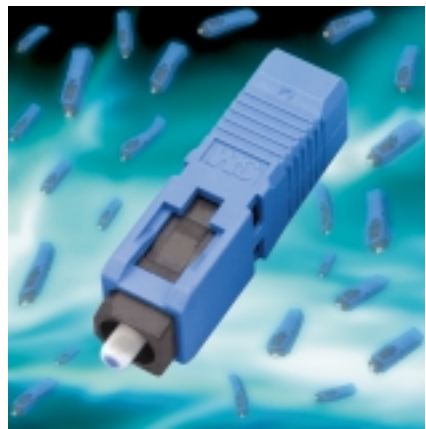

SC Hot Melt Connector

3

All 3M SC Connectors are available without the 3M logo for private labeling.

# SC Connectors and Cable Assemblies

Features	Benefits
Intermateable within NTT specifications	No retrofit, compatibility issues
Push pull mating	High density, repeatable connections
Pull-proof (independent) ferrule	Maintains optical contact
3M PC finish	Excellent transmission performance
Zirconia ceramic ferrule	Reduces reflectance problems Factory polish to -55 dB reflections (single-mode epoxy only)* Field polish to -45 dB reflections (single-mode epoxy only)*
Thermoplastic shell	Corrosion resistant
Fewer parts	Fast, simple termination

## Hot Melt Version Only (in addition to above)

Pre-loaded Hot Melt adhesive	Extended shelf life, fewer consumables (saves money)
No waiting for epoxy to cure	Termination in 2 minutes (productivity)
Single step polish	Only one abrasive to buy; faster polishing (reduces cost)

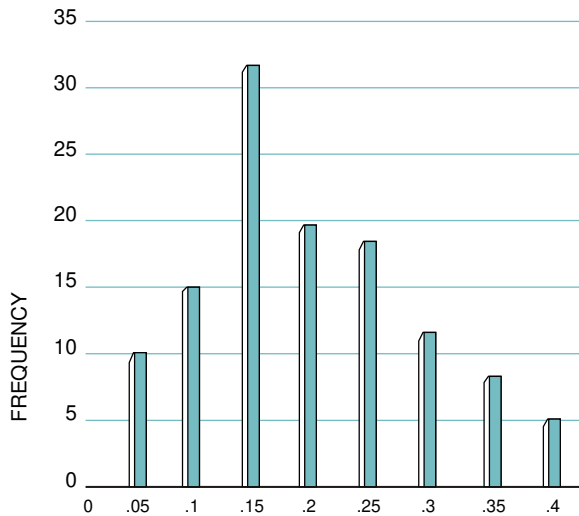
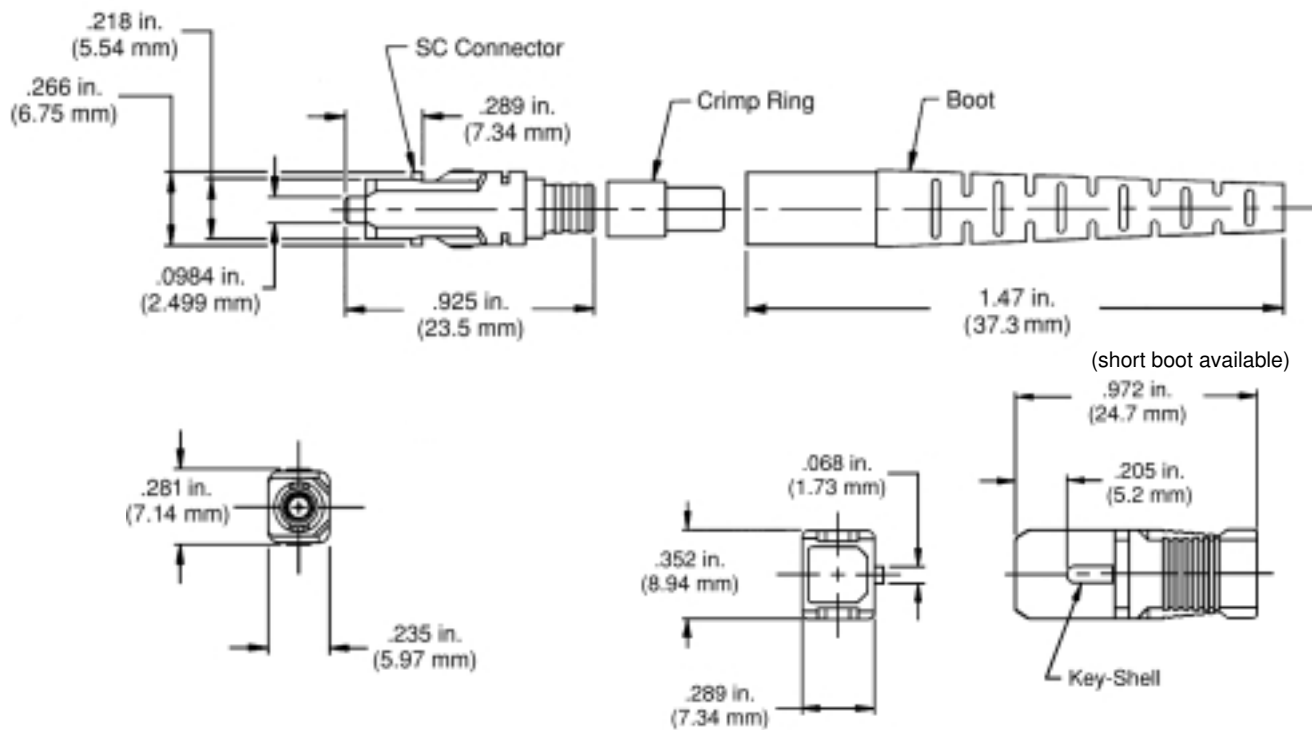

Single-Mode Epoxy Insertion Loss (dB)

Mean: 0.19 dB; SiGma: 0.085 dB PoPulation Size = 121 Pieces

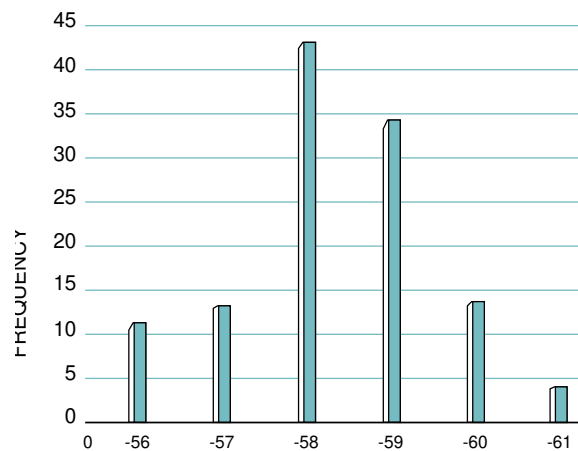

Single-Mode Epoxy Reflection (dB)

Mean: -.58dB; SiGma: 1.01 dB PoPulation Size = 121 Pieces



# SC 8° Angled PC Cable Assemblies

Features	Benefits
8° Angle polish on ferrule (patents issued US 5,351,327, US 5,458,582, US 5,321,784)	Low reflections, mated or unmated; intermateable with other SC 8° angled connectors meeting industry standards
Contacting fibers	Low, stable insertion loss
Isolated ferrule design	Not affected by cable disturbance
Push-pull mating (SC)	High density, repeatable connections
Zirconia ceramic ferrule	Durable, compliant material
Thermoplastic shell	Corrosion resistant

## SC 8° Angled PC Cable Assemblies, Single-mode

In order to meet the system requirements of the cable TV industry and other high-speed digital systems, 3M has developed a single-mode SC 8° angle-polished connector to minimize reflections to a mean of -80 dB.

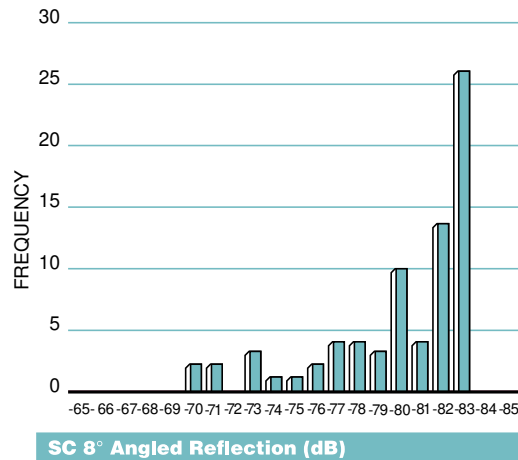
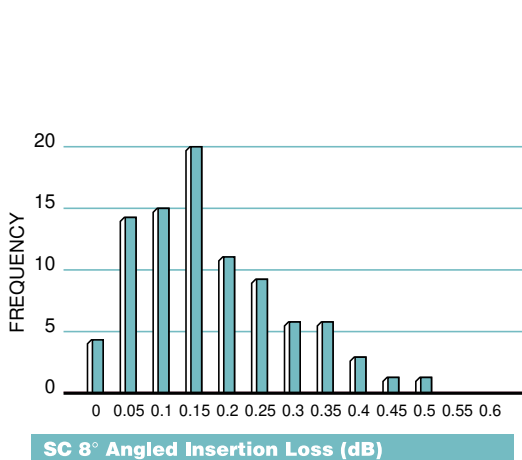
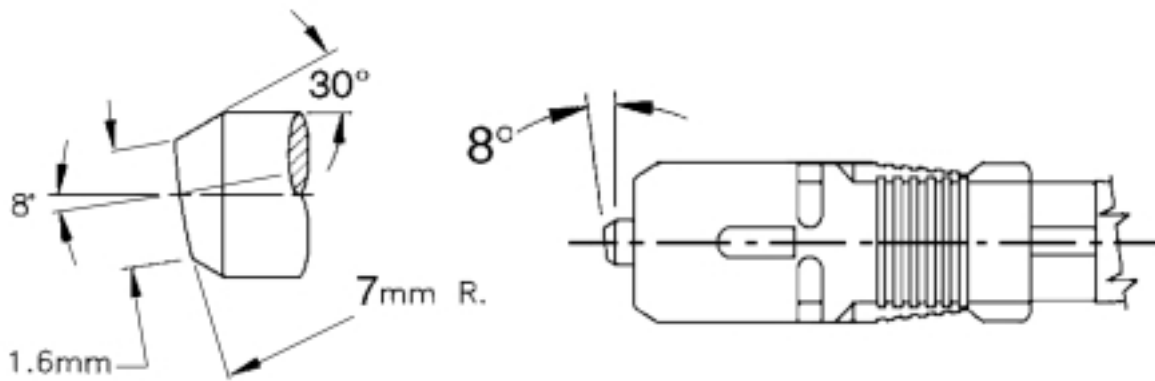

## Specifications for SC Connectors

	Multimode			Single-mode			
Product Number	6300	6900	6306	8300	8306 8307	8900	8306-APC
Connector type	Hot Melt	Crimplok™	Epoxy	Hot Melt	Epoxy	Crimplok	Epoxy
Fiber size (µm)	125	125	125	126	126 127	126	126
Fiber attenuation (dB) Field mount @ 1300 nm	<0.2 typical (62.5/125 µm fiber)	<0.2 typical (62.5/125 µm fiber)	<0.2 typical (62.5/125 µm fiber)	<0.2 typical	<0.3 typical	<0.2 typical	<0.3 typical
Reflection (dB) Field mount	≤25 typical	≤27 typical	≤25 typical	≤25 typical	≤45 typical	≤40 typical	≤65 typical
Connection durability (dB), after 500 matings	<0.2 change	<0.22 change	<0.2 change	<0.2 change	<0.2 change	<0.22 change	<0.2 change
Operating temperature Connector only (cable dependent)	-40° to 60°C (-40° to 140°F)	-10° to 60°C (14° to 140°F)	-40° to 85°C (-40° to 185°F)	-40° to 60°C (-40° to 140°F)	-40° to 85°C (-40° to 185°F)	-10° to 60°C (14° to 140°F)	-40° to 85°C (-40° to 185°F)
Storage temperature	-40° to 85°C (-40° to 185°F)	-40° to 80°C (-40° to 176°F)	-40° to 85°C (-40° to 185°F)	-40° to 85°C (-40° to 185°F)	-40° to 85°C (-40° to 185°F)	-40° to 80°C (-40° to 176°F)	-40° to 85°C (-40° to 185°F)
Cable tension (in service) Straight pull	<0.5 dB increase at 7.5 lbs.	<0.5 dB increase at 20 lbs.	<0.5 dB increase at 7.5 lbs.	<0.5 dB increase at 7.5 lbs.	<0.5 dB increase at 7.5 lbs.	<0.5 dB increase at 20 lbs.	<0.5 dB increase at 7.5 lbs.
Side pull	<0.5 dB increase at 3 lbs.	<0.5 dB increase at 3 lbs.	<0.5 dB increase at 3 lbs.	<0.5 dB increase at 3 lbs.	<0.5 dB increase at 3 lbs.	<0.5 dB increase at 3 lbs.	<0.5 dB increase at 3 lbs.
Material Connector ferrule Connector body & housing Boot	Zirconia ceramic Engineering Thermoplastic Elastomer resin	Zirconia ceramic Engineering Thermoplastic Elastomer resin	Zirconia ceramic Engineering Thermoplastic Elastomer resin	Zirconia ceramic Engineering Thermoplastic Elastomer resin	Zirconia ceramic Engineering Thermoplastic Elastomer resin	Zirconia ceramic Engineering Thermoplastic Elastomer resin	8° angle Zirconia ceramic Elastomer resin
Flame retardancy	UL-94 V-0	UL-94 V-0	UL-94 V-0	UL-94 V-0	UL-94 V-0	UL-94 V-0	UL-94 V-0
Connector identification Body Outer shell Boot	Black Beige White	Black Beige Black	Beige Beige Beige	Black Blue White	Beige Blue White	Black Blue Black	Beige Green Green
Field Termination Kit 120 V 230 V	6355 6351	6955 (no power needed)	8365 8361	6355 6351	8365 8361	6955 (no power needed)	8366 Conversion Kit

### Use 3M Universal Termination Kits for an organized, quick installation

The 8365/8361 kit includes all tools and supplies necessary to terminate all epoxy connectors with a high temperature epoxy to meet Bellcore environmental tests.

The 8365/8361 kit also includes a polishing procedure that enables the installer to meet a –40 dB reflection requirement.

The 8366 SC APC conversion kit includes a polishing procedure that enables the installer to meet a –65 dB reflection requirement.

The 6355/6351 Hot Melt termination kit will provide all the equipment needed to terminate all 3M Hot Melt connectors.

The 6955 Crimplok™ termination kit provides all the equipment needed to terminate all 3M Crimplok connectors.

# Ordering Guide

Description	Product Number	Packaging
<b>Field-mountable connectors</b>		
Single-mode/Epoxy (126µm)	8306	1/pkg., 60/cs.
Single-mode/Epoxy (127µm)	8307	1/pkg., 60/cs.
Single-mode/Hot Melt (126µm)	8300	1/pkg., 60/cs.
Single-mode APC Epoxy (126µm)	8306-APC	1/pkg., 60/cs.
Single-mode Low EMI (blue boot)	8309-U	1/pkg., 60/cs.
Single-mode Low EMI (white boot)	8309-W	1/pkg., 60/cs.
Single-mode Crimplok™ (126µm)	8900	1/pkg., 60/cs.
Multimode/Epoxy (125µm)	6306	1/pkg., 60/cs.
Multimode/Hot Melt (125µm)	6300	1/pkg., 60/cs.
Multimode Low EMI (beige boot)	6309-BE	1/pkg., 60/cs.
Multimode Low EMI (white boot)	6309-W	1/pkg., 60/cs.
Multimode Crimplok™ (125µm)	6900	1/pkg., 60/cs.
<b>Cable assembly*</b>		
Single-mode, connector code	DA	1/pkg., 1/cs.
Single-mode, 8° angle	EP	1/pkg., 1/cs.
Single-mode Low EMI	DT	1/pkg., 1/cs.
Multimode, connector code	DB	1/pkg., 1/cs.
Multimode Low EMI	DS	1/pkg., 1/cs.
<b>Couplings</b>		
Single-mode simplex	8310	1/pkg., 60/cs.
Single-mode duplex	8313	1/pkg., 60/cs.
Single-mode APC	8310-G	1/pkg., 60/cs.
Multimode simplex	6310	
Multimode duplex	6313	
<b>Complete universal termination kits</b>		
Single-mode and Multimode ST, SC & FC Termination Kit, 120V Oven, Epoxy	8365	1/each, 1/cs.
Single-mode and Multimode ST, SC & FC Termination Kit, 230V Oven, Epoxy	8361	1/each, 1/cs.
SC Angled Polished Connector Conversion Kit	8366	1/each, 1/cs.
Hot Melt Fiber Optic Termination Kit, ST, SC & FC 120V Oven	6355	1/each, 1/cs.
Hot Melt Fiber Optic Termination Kit, ST, SC & FC, 230V Oven	6351	1/each, 1/cs.
Crimplok Fiber Optic Termination Kit ST & SC Single-mode & Multimode	6955	1/each, 1/cs.

\* Please refer to cable assembly ordering guide, or price book for complete part numbers

## Ordering Information

To order, specify the correct product number from the Ordering Guide chart. For more information, please contact a 3M sales representative 800/426/8688.

3M and Crimplok are trademarks of 3M.

## Important Notice

All statements, technical information, and recommendations related to 3M's products are based on information believed to be reliable, but the accuracy or completeness is not guaranteed. Before using this product, you must evaluate it and determine if it is suitable for your intended application. You assume all risks and liability associated with such use. Any statements related to the product which are not contained in 3M's current publications, or any contrary statements contained on your purchase order shall have no force or effect unless expressly agreed upon, in writing, by an authorized officer of 3M.

## Warranty; Limited Remedy; Limited Liability.

This product will be free from defects in material and manufacture for a period of one year from the date of purchase. **3M MAKES NO OTHER WARRANTIES INCLUDING, BUT NOT LIMITED TO, ANY IMPLIED WARRANTY OF MERCHANTABILITY OR FITNESS FOR A PARTICULAR PURPOSE.** If this product is defective within the warranty period stated above, your exclusive remedy shall be, at 3M's option, to replace or repair the 3M product or refund the purchase price of the 3M product. **Except where prohibited by law, 3M will not be liable for any loss or damage arising from this 3M product, whether direct, indirect, special, incidental or consequential regardless of the legal theory asserted.**



## Telecommunications

6801 River Place Blvd.  
Austin, TX 78726-9000  
800/426 8688  
FAX 800/626 0329  
www.3M.com/telecom



Recycled Paper  
40% Pre-consumer  
10% Post-consumer

Litho in USA.

© 3M IPC 2001 80-6111-3107-1