



Chipsmall Limited consists of a professional team with an average of over 10 year of expertise in the distribution of electronic components. Based in Hongkong, we have already established firm and mutual-benefit business relationships with customers from,Europe,America and south Asia,supplying obsolete and hard-to-find components to meet their specific needs.

With the principle of “Quality Parts,Customers Priority,Honest Operation,and Considerate Service”,our business mainly focus on the distribution of electronic components. Line cards we deal with include Microchip,ALPS,ROHM,Xilinx,Pulse,ON,Everlight and Freescale. Main products comprise IC,Modules,Potentiometer,IC Socket,Relay,Connector.Our parts cover such applications as commercial,industrial, and automotives areas.

We are looking forward to setting up business relationship with you and hope to provide you with the best service and solution. Let us make a better world for our industry!



Contact us

Tel: +86-755-8981 8866 Fax: +86-755-8427 6832

Email & Skype: info@chipsmall.com Web: www.chipsmall.com

Address: A1208, Overseas Decoration Building, #122 Zhenhua RD., Futian, Shenzhen, China



Miniature

→ 83 160

- Nominal ratings up to 16 A/250 VAC
- Self-cleaning contacts
- 3 mm contact gap for type 83 160 6
- High DC switch rating for type 83 160 6 SP 3697
- Choice of actuators
- Approvals NF - UL (except 83 160 6 SP 3697)



Main specifications

		Standard 83 160 0
Function	Connections	
I (changeover)	W3	
I (changeover)	W2 - W6 - X1 *	83 160 006
R (normally closed)	W2 - W3 - W6 - X1 *	●
C (normally open)	W2 - W3 - W6 - X1 *	●
		●
Electrical characteristics		
Rating nominal / 250 V AC (A)		16
Rating thermal / 250 V AC (A)		20
Rating nominal / 250 V DC (A)		-
Rating thermal / 250 V DC (A)		-
Mechanical characteristics		
Maximum operating force (N)		4
Min. Release force (N)		1.5
Maximum total travel force (N)		6.5
Max. permitted overtravel force (N)		20
Rest position max. (mm)		15.6
Tripping point (mm)		14.8 ^{+0.3}
Maximum differential travel (mm)		0.3
Min. overtravel CRA (mm)		1.3
Ambient operating temperature (°C)		-20 → +125
Mechanical life for 2/3 CRA (operations)		10 ⁷
Contact gap (mm)		1.2
Weight (g)		6.7
Comments		
* X1 for 83 160 6 and 83 160 6 SP 3697 : please consult us		

Additional specifications

Components

Material

- Case : 83 160 0, 3, 4 and 6 polyamide UL94VO.
- Contacts : nickel silver

Lever

- stainless steel
- polyamide roller

Approvals : NF

Product adaptations



- Special levers
- Approvals : NF - UL for 83 160 6 SP 3697

To order, see page 12

Principles

Single break changeover switch

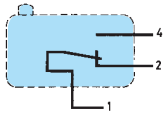

Reduced force 83 160 3	Low force 83 160 4	3 mm contact gap 83 160 6	High DC switch rating 83 160 6 SP 3697
83 160 301	83 160 401	•	•
•	•	•	•
•	•	•	•
10	6	16	-
15	10	20	-
-	-	-	5
-	-	-	5
2	1	5	5
0.6	0.3	1	1
3	1.5	7	7
20	20	20	20
15.6	15.6	15.7	15.7
14.8 ^{+0.3}	14.7 ^{+0.3}	14.6 ^{+0.4}	14.6 ^{+0.4}
0.4	0.35	0.7	0.7
1.3	1.3	1	1
-20 → +125	-20 → +125	-20 → +125	-20 → +125
10 ⁷	10 ⁷	10 ⁶	10 ⁶
1.2	1.2	3.2	3.2
6.7	6.7	6.7	6.7

Curves

Operating curve for types 83 160 0 / 3 / 4 / 6

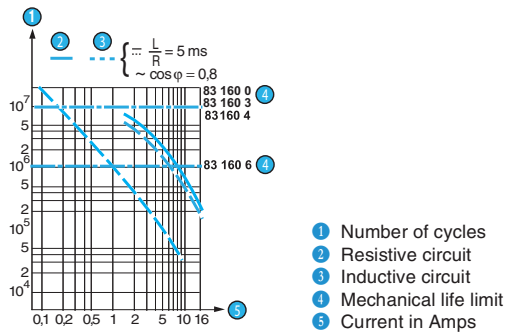

83 160 6 SP 3697

at 250 VDC 1 A L/R 5 ms = 15000 cycles
 at 130 VDC 2.6 A L/R 5 ms = 15000 cycles

Dimensions

→ Product

83 160 0 / 3 / 4 / 6

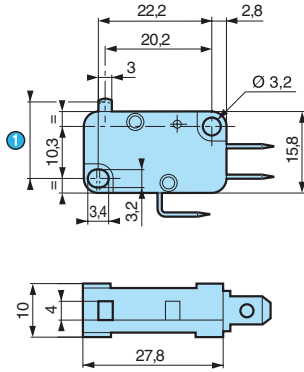

① OL = 13.2 max.

83 160 6 SP 3697

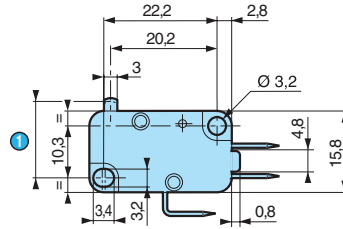

① OL = 13.2 max.

→ Connections

W2 solder

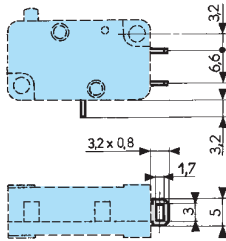

X1 printed circuit board

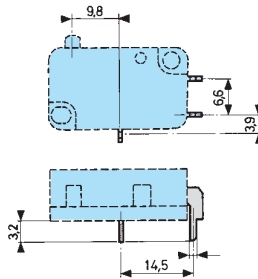

W3 for 6.35 mm clips

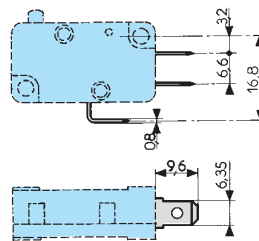

W6 for 4.75 mm clips

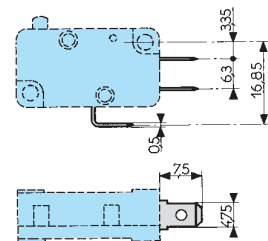

→ Actuator mounting positions

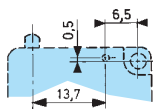

→ Actuators

153 AX

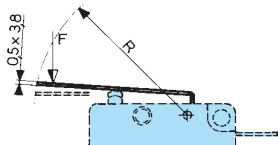

153 EX

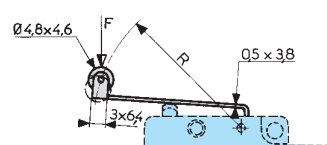

Actuators and fixing positions

Part numbers for standard actuators

70 545 0 / 153 A F29.7

70 545 0 / 153 ER15,8

70 545 0 / 153 EF28.7

Actuators

Flat 153 AX F29.7

Roller 153 EX R15,8

Roller 153 EX F28.7



		831600	831603	831606	831600	831603	831606	831600	831603	831606
Fixing positions	mm	15,3 ^{+0,05}	15,3 ^{+0,05}	14,4 ^{+0,06}	20,5 ^{+0,45}	20,5 ^{+0,45}	20,3 ^{+0,55}	20,5 ^{+0,65}	20,5 ^{+0,65}	19,6 ^{+0,75}
Operating force - max.	N	2	1	2,6	4	2	5	2	1	2,6
Release force - min.	N	0,4	0,25	0,3	1	0,55	0,75	0,4	0,25	0,3
Pre-travel - max.	mm	2,5	2,5	3,1	1,2	1,2	1,4	2,5	2,5	3,1
Differential travel max.	mm	0,6	0,8	1,5	0,3	0,4	0,7	0,6	0,8	1,5
Total travel max.	mm	2,3	2,3	2,3	2,3	2,3	2,3	4,6	4,6	4,6

2-pole 153 A2** R15,9

Dummy roller F** F24.3

Telescopic plunger 153L**
(operating temperature 125°C max.)

Flexible with roller 153 B**

153 V**

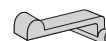
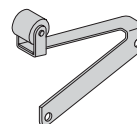
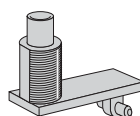

** Please consult us

Other information

Mounting - Operation

See basic technical concepts

1