



Chipsmall Limited consists of a professional team with an average of over 10 year of expertise in the distribution of electronic components. Based in Hongkong, we have already established firm and mutual-benefit business relationships with customers from,Europe,America and south Asia,supplying obsolete and hard-to-find components to meet their specific needs.

With the principle of "Quality Parts,Customers Priority,Honest Operation,and Considerate Service",our business mainly focus on the distribution of electronic components. Line cards we deal with include Microchip,ALPS,ROHM,Xilinx,Pulse,ON,Everlight and Freescale. Main products comprise IC,Modules,Potentiometer,IC Socket,Relay,Connector.Our parts cover such applications as commercial,industrial, and automotives areas.

We are looking forward to setting up business relationship with you and hope to provide you with the best service and solution. Let us make a better world for our industry!



## Contact us

Tel: +86-755-8981 8866 Fax: +86-755-8427 6832

Email & Skype: info@chipsmall.com Web: www.chipsmall.com

Address: A1208, Overseas Decoration Building, #122 Zhenhua RD., Futian, Shenzhen, China



### GENERAL DESCRIPTION

The 844021-01 is an Ethernet Clock Generator. The 844021-01 uses an 18pF parallel resonant crystal over the range of 24.5MHz – 34MHz. For Ethernet applications, a 25MHz crystal is used. The 844021-01 has excellent <1ps phase jitter performance, over the 1.875MHz – 20MHz integration range. The 844021-01 is packaged in a small 8-pin TSSOP, making it ideal for use in systems with limited board space.

### FEATURES

- One Differential LVDS output
- Crystal oscillator interface, 18pF parallel resonant crystal (24.5MHz – 34MHz)
- Output frequency range: 122.5MHz – 170MHz
- VCO range: 490MHz – 680MHz
- RMS phase jitter @ 125MHz, using a 25MHz crystal (1.875MHz – 20MHz): 0.32ps (typical) @ 3.3V
- 3.3V or 2.5V operating supply
- 0°C to 70°C ambient operating temperature
- Available in lead-free (RoHS 6) package

COMMON CONFIGURATION TABLE - Gb ETHERNET

Inputs				Output Frequency (MHz)
Crystal Frequency (MHz)	M	N	Multiplication Value M/N	
25	20	4	5	125
26.666	20	4	5	133.33
33.33	20	4	5	166.66

### BLOCK DIAGRAM

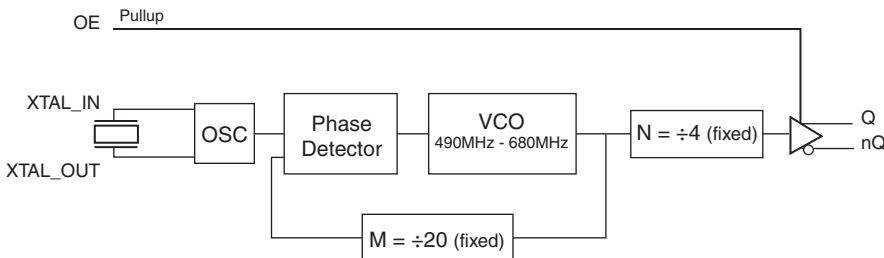

### PIN ASSIGNMENT

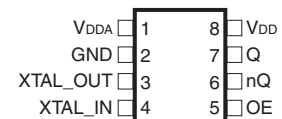

#### 844021-01

#### 8-Lead TSSOP

4.40mm x 3.0mm x 0.925mm  
package body  
**G Package**  
Top View

TABLE 1. PIN DESCRIPTIONS

Number	Name	Type		Description
1	V <sub>DDA</sub>	Power		Analog supply pin.
2	GND	Power		Power supply ground.
3, 4	XTAL_OUT, XTAL_IN	Input		Crystal oscillator interface. XTAL_IN is the input, XTAL_OUT is the output.
5	OE	Input	Pullup	Output enable pin. When HIGH, Q/nQ output is active. When LOW, the Q/nQ output is in a high impedance state. LVCMOS/LVT-TL interface levels.
6, 7	nQ, Q	Output		Differential clock outputs. LVDS interface levels.
8	V <sub>DD</sub>	Power		Core supply pin.

NOTE: *Pullup* refers to internal input resistors. See Table 2, Pin Characteristics, for typical values.

TABLE 2. PIN CHARACTERISTICS

Symbol	Parameter	Test Conditions	Minimum	Typical	Maximum	Units
C <sub>IN</sub>	Input Capacitance			4		pF
R <sub>PULLUP</sub>	Input Pullup Resistor			51		kΩ

**ABSOLUTE MAXIMUM RATINGS**

Supply Voltage, $V_{DD}$	4.6V
Inputs, $V_I$	-0.5V to $V_{DD} + 0.5V$
Outputs, $I_O$ (LVDS)	
Continuous Current	10mA
Surge Current	15mA
Package Thermal Impedance, $\theta_{JA}$	129.5°C/W (0 mps)
Storage Temperature, $T_{STG}$	-65°C to 150°C

NOTE: Stresses beyond those listed under Absolute Maximum Ratings may cause permanent damage to the device. These ratings are stress specifications only. Functional operation of product at these conditions or any conditions beyond those listed in the *DC Characteristics* or *AC Characteristics* is not implied. Exposure to absolute maximum rating conditions for extended periods may affect product reliability.

**TABLE 3A. POWER SUPPLY DC CHARACTERISTICS,  $V_{DD} = 3.3V \pm 5\%$ ,  $T_A = 0^\circ\text{C}$  TO  $70^\circ\text{C}$** 

Symbol	Parameter	Test Conditions	Minimum	Typical	Maximum	Units
$V_{DD}$	Core Supply Voltage		3.135	3.3	3.465	V
$V_{DDA}$	Analog Supply Voltage		$V_{DD} - 0.10$	3.3	$V_{DD}$	V
$I_{DD}$	Power Supply Current				75	mA
$I_{DDA}$	Analog Supply Current				10	mA

**TABLE 3B. POWER SUPPLY DC CHARACTERISTICS,  $V_{DD} = 2.5V \pm 5\%$ ,  $T_A = 0^\circ\text{C}$  TO  $70^\circ\text{C}$** 

Symbol	Parameter	Test Conditions	Minimum	Typical	Maximum	Units
$V_{DD}$	Core Supply Voltage		2.375	2.5	2.625	V
$V_{DDA}$	Analog Supply Voltage		$V_{DD} - 0.10$	2.5	$V_{DD}$	V
$I_{DD}$	Power Supply Current				70	mA
$I_{DDA}$	Analog Supply Current				10	mA

**TABLE 3C. LVC MOS/LVTTL DC CHARACTERISTICS,  $V_{DD} = 3.3V \pm 5\%$  OR  $2.5V \pm 5\%$ ,  $T_A = 0^\circ\text{C}$  TO  $70^\circ\text{C}$** 

Symbol	Parameter	Test Conditions	Minimum	Typical	Maximum	Units
$V_{IH}$	Input High Voltage	$V_{DD} = 3.3V$	2		$V_{DD} + 0.3$	V
		$V_{DD} = 2.5V$	1.7		$V_{DD} + 0.3$	V
$V_{IL}$	Input Low Voltage	$V_{DD} = 3.3V$	-0.3		0.8	V
		$V_{DD} = 2.5V$	-0.3		0.7	V
$I_{IH}$	Input High Current	$V_{DD} = V_{IN} = 3.465V$ or $2.625V$			5	$\mu\text{A}$
$I_{IL}$	Input Low Current	$V_{DD} = 3.465V$ or $2.625V$ , $V_{IN} = 0V$	-150			$\mu\text{A}$



**TABLE 3D. LVDS DC CHARACTERISTICS,  $V_{DD} = 3.3V \pm 5\%$ ,  $T_A = 0^\circ C$  TO  $70^\circ C$** 

Symbol	Parameter	Test Conditions	Minimum	Typical	Maximum	Units
$V_{OD}$	Differential Output Voltage		275		425	mV
$\Delta V_{OD}$	$V_{OD}$ Magnitude Change				50	mV
$V_{OS}$	Offset Voltage		1.15		1.45	V
$\Delta V_{OS}$	$V_{OS}$ Magnitude Change				50	mV

NOTE: Please refer to Parameter Measurement Information for output information.

**TABLE 3E. LVDS DC CHARACTERISTICS,  $V_{DD} = 2.5V \pm 5\%$ ,  $T_A = 0^\circ C$  TO  $70^\circ C$** 

Symbol	Parameter	Test Conditions	Minimum	Typical	Maximum	Units
$V_{OD}$	Differential Output Voltage		215		430	mV
$\Delta V_{OD}$	$V_{OD}$ Magnitude Change				50	mV
$V_{OS}$	Offset Voltage		1.05		1.45	V
$\Delta V_{OS}$	$V_{OS}$ Magnitude Change				50	mV

NOTE: Please refer to Parameter Measurement Information for output information.

**TABLE 4. CRYSTAL CHARACTERISTICS**

Parameter	Test Conditions	Minimum	Typical	Maximum	Units
Mode of Oscillation		Fundamental			
Frequency		24.5		34	MHz
Equivalent Series Resistance (ESR)				50	$\Omega$
Shunt Capacitance				7	pF

NOTE: It is not recommended to overdrive the crystal input with an external clock.

**TABLE 5. AC CHARACTERISTICS,  $V_{DD} = 3.3V \pm 5\%$  OR  $2.5V \pm 5\%$ ,  $T_A = 0^\circ C$  TO  $70^\circ C$** 

Symbol	Parameter	Test Conditions	Minimum	Typical	Maximum	Units
$f_{OUT}$	Output Frequency		122.5		170	MHz
$t_{jit}(\emptyset)$	RMS Phase Jitter ( Random); NOTE 1	125MHz @ Integration Range: 1.875MHz - 20MHz		0.32		ps
$t_R / t_F$	Output Rise/Fall Time	20% to 80%	200		400	ps
$odc$	Output Duty Cycle		48		52	%

NOTE 1: Please refer to the Phase Noise Plots following this section.

### TYPICAL PHASE NOISE AT 125MHz @ 3.3V

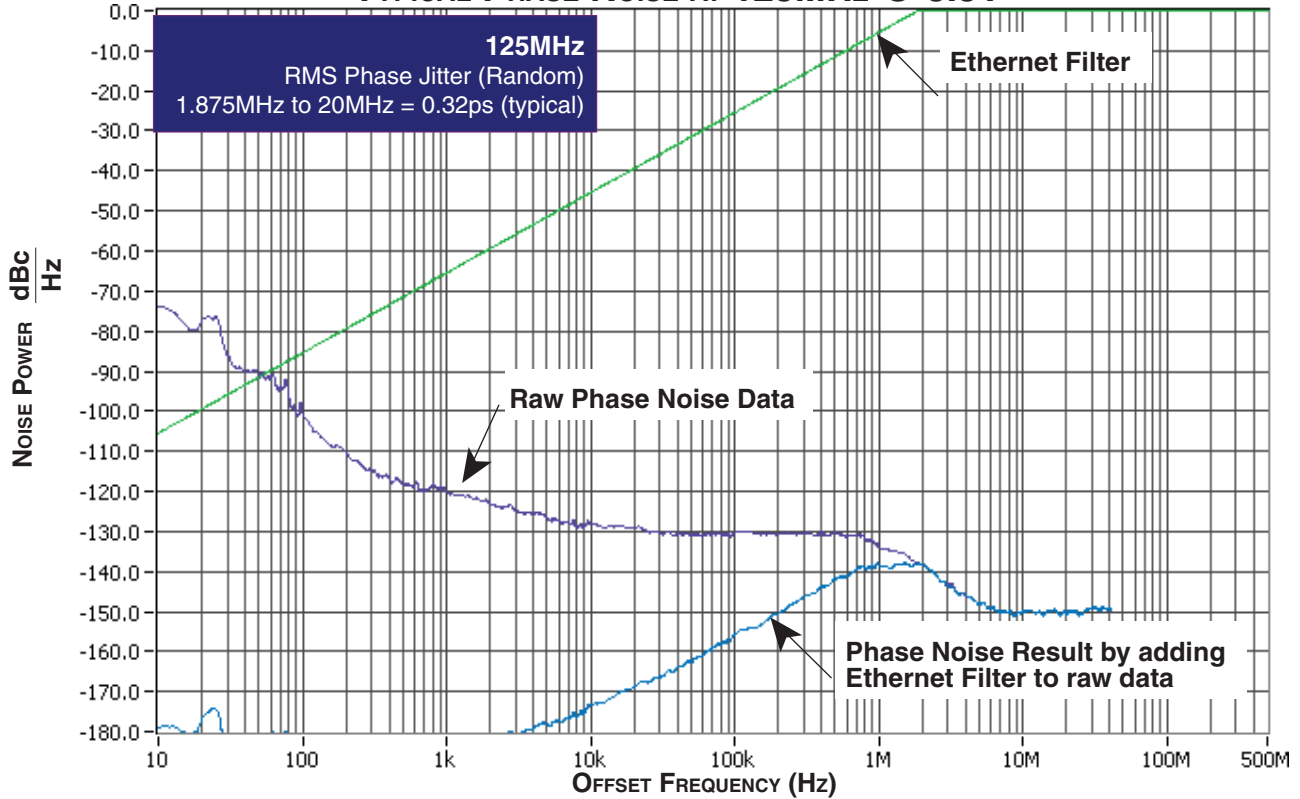

### TYPICAL PHASE NOISE AT 125MHz @ 2.5V

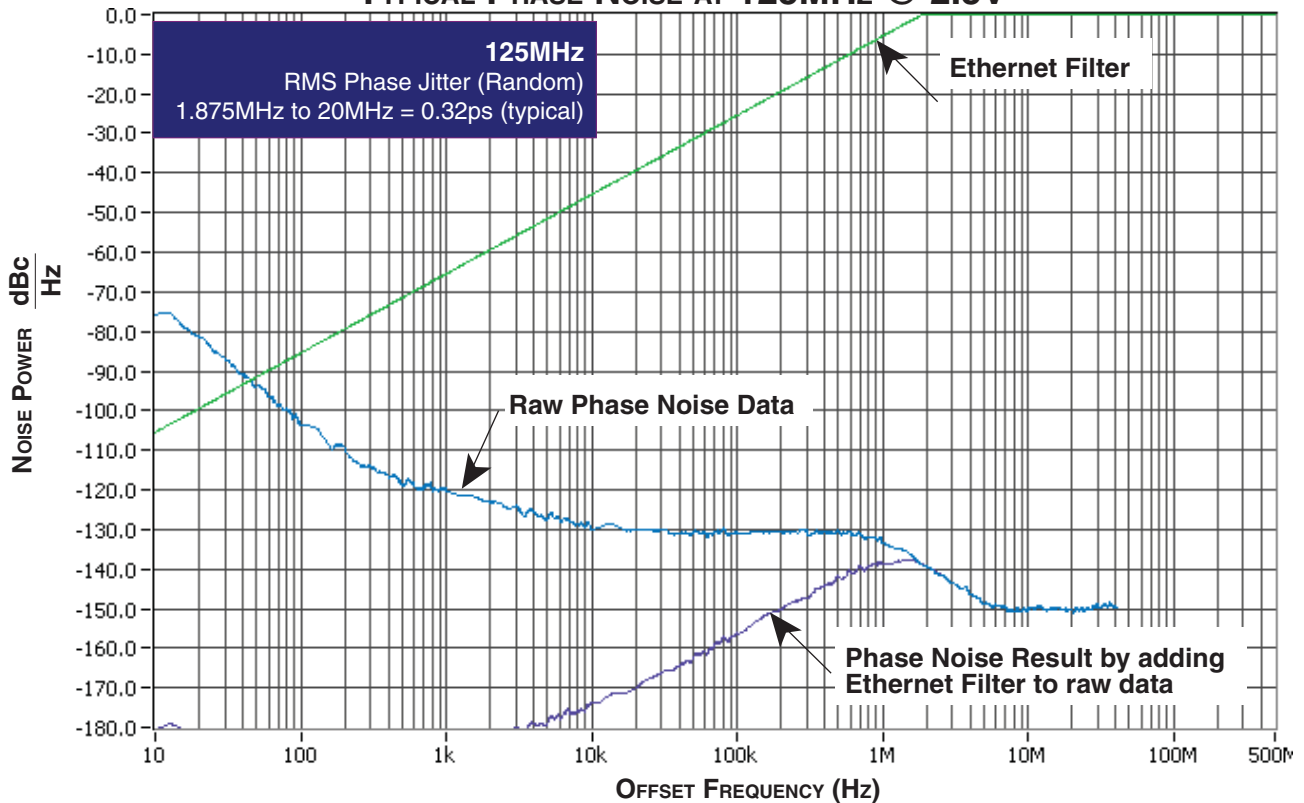

# PARAMETER MEASUREMENT INFORMATION

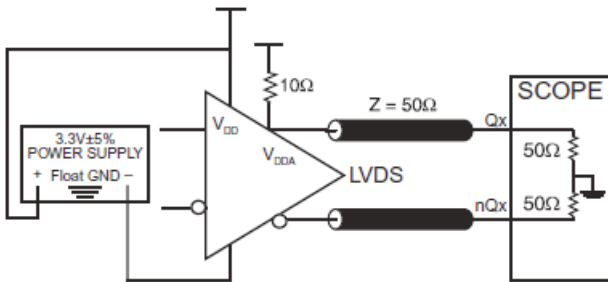

**LVDS 3.3V OUTPUT LOAD AC TEST CIRCUIT**

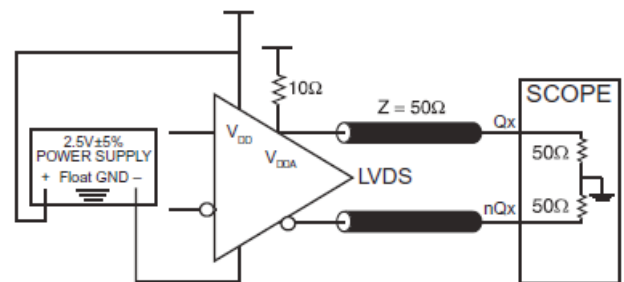

**LVDS 2.5V OUTPUT LOAD AC TEST CIRCUIT**

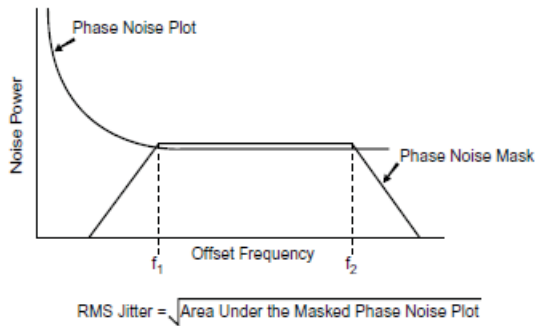

**RMS PHASE JITTER**

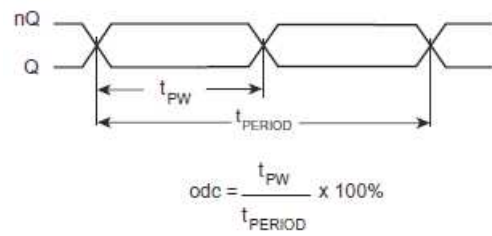

**OUTPUT DUTY CYCLE/PULSE WIDTH/PERIOD**

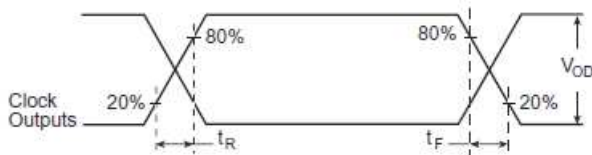

**OUTPUT RISE/FALL TIME**

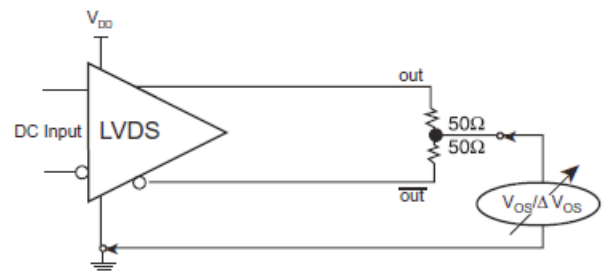

**OFFSET VOLTAGE SETUP**

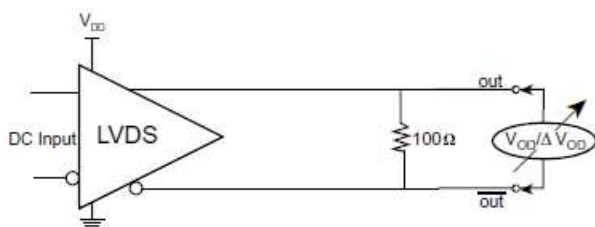

**DIFFERENTIAL OUTPUT VOLTAGE SETUP**

## APPLICATION INFORMATION

### POWER SUPPLY FILTERING TECHNIQUES

As in any high speed analog circuitry, the power supply pins are vulnerable to random noise. To achieve optimum jitter performance, power supply isolation is required. The 844021-01 provides separate power supplies to isolate any high switching noise from the outputs to the internal PLL.  $V_{DD}$  and  $V_{DDA}$  should be individually connected to the power supply plane through vias, and  $0.01\mu\text{F}$  bypass capacitors should be used for each pin. *Figure 1* illustrates this for a generic  $V_{DD}$  pin and also shows that  $V_{DDA}$  requires that an additional  $10\Omega$  resistor along with a  $10\mu\text{F}$  bypass capacitor be connected to the  $V_{DDA}$  pin.

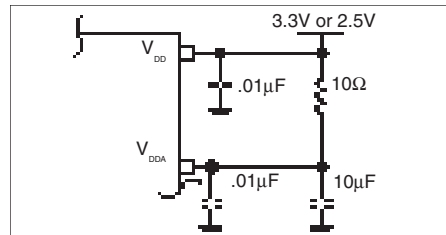

FIGURE 1. POWER SUPPLY FILTERING

### CRYSTAL INPUT INTERFACE

The 844021-01 has been characterized with  $18\text{pF}$  parallel resonant crystals. The capacitor values,  $C1$  and  $C2$ , shown in *Figure 2* below were determined using a  $25\text{MHz}$ ,  $18\text{pF}$  parallel

resonant crystal and were chosen to minimize the ppm error. The optimum  $C1$  and  $C2$  values can be slightly adjusted for different board layouts.

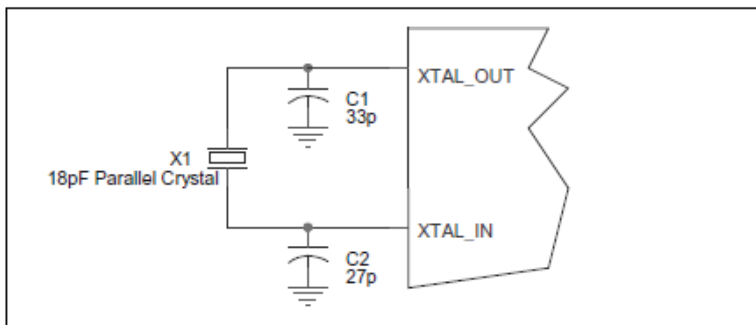

FIGURE 2. CRYSTAL INPUT INTERFACE



### 3.3V, 2.5V LVDS DRIVER TERMINATION

A general LVDS interface is shown in *Figure 4*. In a  $100\Omega$  differential transmission line environment, LVDS drivers require a matched load termination of  $100\Omega$  across near

the receiver input. For a multiple LVDS outputs buffer, if only partial outputs are used, it is recommended to terminate the unused outputs.

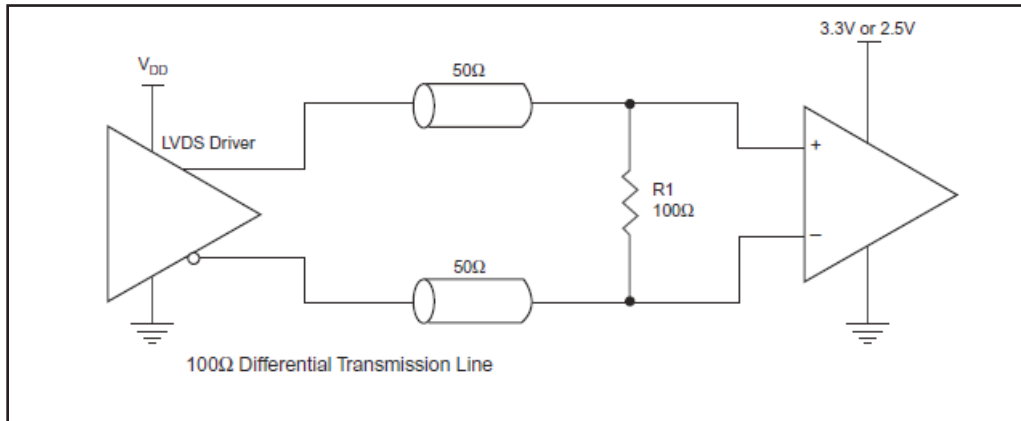
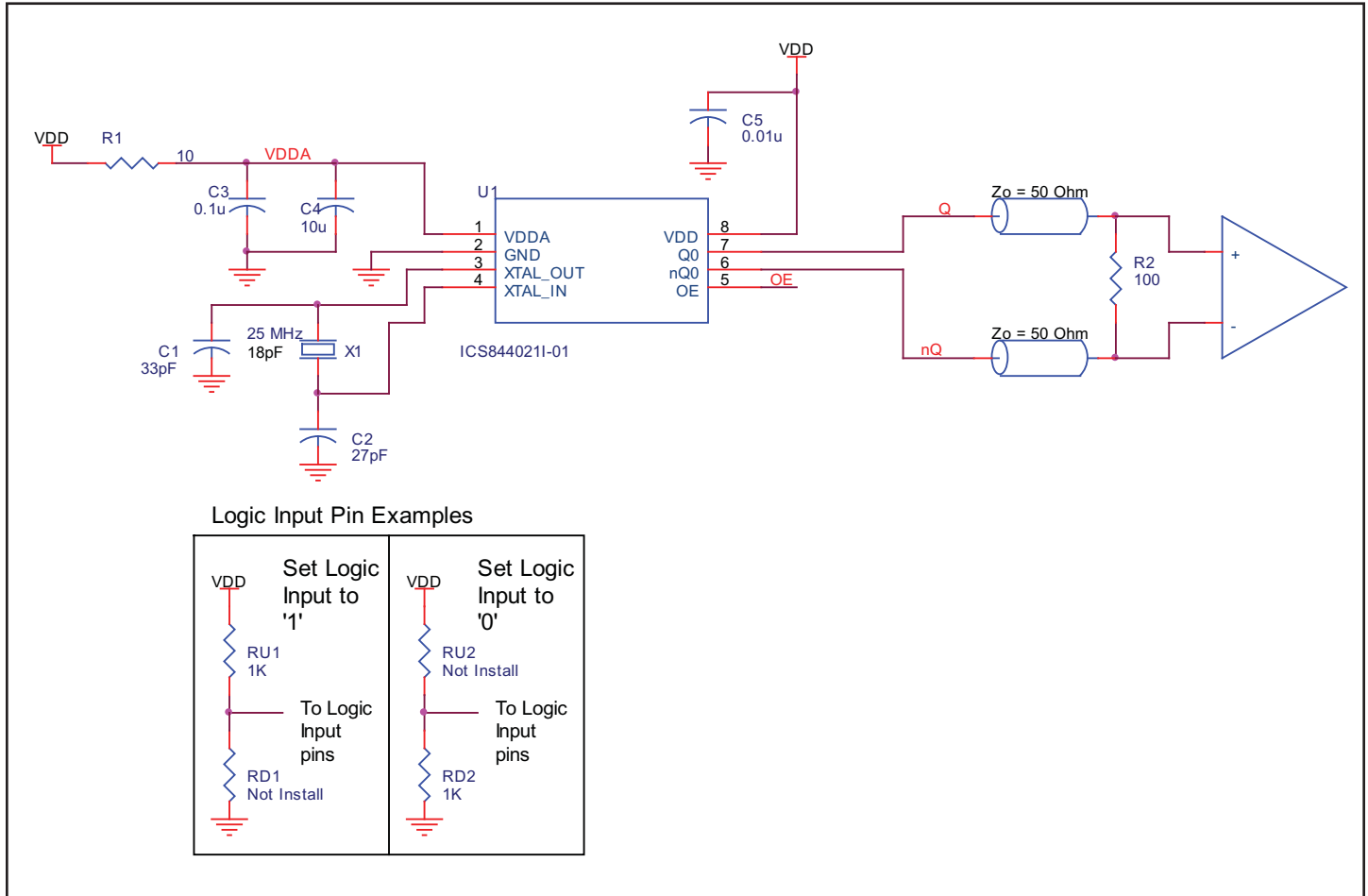

**FIGURE 4. TYPICAL LVDS DRIVER TERMINATION**

**SCHEMATIC LAYOUT**

Figure 5 shows an example of 844021-01 application schematic. In this example, the device is operated at  $V_{DD} = 3.3V$ . The decoupling capacitor should be located as close as possible to the power pin. The 18pF parallel resonant 25MHz crystal is used. The  $C1 = 33pF$  and  $C2 = 27pF$  are recommended

for frequency accuracy. For different board layout, the  $C1$  and  $C2$  may be slightly adjusted for optimizing frequency accuracy. For the LVDS output drivers, place a  $100\Omega$  resistor as close to the receiver as possible.



**FIGURE 5. 844021-01 SCHEMATIC LAYOUT**

## POWER CONSIDERATIONS

This section provides information on power dissipation and junction temperature for the 844021-01. Equations and example calculations are also provided.

### 1. Power Dissipation.

The total power dissipation for the 844021-01 is the sum of the core power plus the analog plus the power dissipated in the load(s). The following is the power dissipation for  $V_{DD} = 3.3V + 5\% = 3.465V$ , which gives worst case results.

- Power (core)<sub>MAX</sub> =  $V_{DD\_MAX} * (I_{DD\_MAX} + I_{DDA\_MAX}) = 3.465V * (75mA + 10mA) = \mathbf{294.5mW}$

### 2. Junction Temperature.

Junction temperature,  $T_j$ , is the temperature at the junction of the bond wire and bond pad and directly affects the reliability of the device. The maximum recommended junction temperature is 125°C.

The equation for  $T_j$  is as follows:  $T_j = \theta_{JA} * Pd\_total + T_A$

$T_j$  = Junction Temperature

$\theta_{JA}$  = Junction-to-Ambient Thermal Resistance

$Pd\_total$  = Total Device Power Dissipation (example calculation is in section 1 above)

$T_A$  = Ambient Temperature

In order to calculate junction temperature, the appropriate junction-to-ambient thermal resistance  $\theta_{JA}$  must be used. Assuming no air flow and a multi-layer board, the appropriate value is 129.5°C/W per Table 6 below.

Therefore,  $T_j$  for an ambient temperature of 70°C with all outputs switching is:  
 $70^\circ\text{C} + 0.295\text{W} * 129.5^\circ\text{C/W} = 108.2^\circ\text{C}$ . This is well below the limit of 125°C.

This calculation is only an example.  $T_j$  will obviously vary depending on the number of loaded outputs, supply voltage, air flow, and the type of board (single layer or multi-layer).

**TABLE 6. THERMAL RESISTANCE  $\theta_{JA}$  FOR 8-LEAD TSSOP, FORCED CONVECTION**

$\theta_{JA}$ by Velocity (Meters per Second)			
	0	1	2.5
Multi-Layer PCB, JEDEC Standard Test Boards	129.5°C/W	125.5°C/W	123.5°C/W

# RELIABILITY INFORMATION

TABLE 7.  $\theta_{JA}$  vs. AIR FLOW TABLE FOR 8 LEAD TSSOP

$\theta_{JA}$ by Velocity (Meters per Second)			
Multi-Layer PCB, JEDEC Standard Test Boards	0	1	2.5
	129.5°C/W	125.5°C/W	123.5°C/W

**TRANSISTOR COUNT**

The transistor count for 844021-01 is: 2533

# PACKAGE OUTLINE & DIMENSIONS

PACKAGE OUTLINE - G SUFFIX FOR 8 LEAD TSSOP

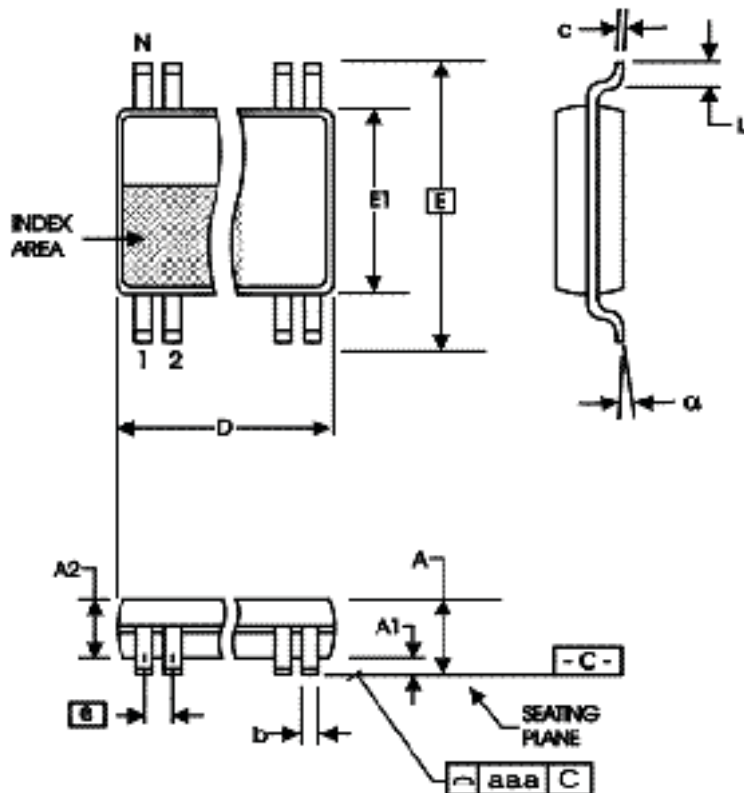

TABLE 8. PACKAGE DIMENSIONS

SYMBOL	Millimeters	
	Minimum	Maximum
N	8	
A	--	1.20
A1	0.05	0.15
A2	0.80	1.05
b	0.19	0.30
c	0.09	0.20
D	2.90	3.10
E	6.40 BASIC	
E1	4.30	4.50
e	0.65 BASIC	
L	0.45	0.75
alpha	0°	8°
aaa	--	0.10

Reference Document: JEDEC Publication 95, MO-153

**TABLE 9. ORDERING INFORMATION**

Part/Order Number	Marking	Package	Shipping Packaging	Temperature
844021BG-01LF	1B01L	8 lead "Lead-Free" TSSOP	tube	0°C to 70°C
844021BG-01LFT	1B01L	8 lead "Lead-Free" TSSOP	tape & reel	0°C to 70°C

NOTE: Parts that are ordered with an "LF" suffix to the part number are the Pb-Free configuration and are RoHS compliant.

While the information presented herein has been checked for both accuracy and reliability, Integrated Device Technology, Incorporated (IDT) assumes no responsibility for either its use or for infringement of any patents or other rights of third parties, which would result from its use. No other circuits, patents, or licenses are implied. This product is intended for use in normal commercial applications. Any other applications such as those requiring extended temperature ranges, high reliability or other extraordinary environmental requirements are not recommended without additional processing by IDT. IDT reserves the right to change any circuitry or specifications without notice. IDT does not authorize or warrant any IDT product for use in life support devices or critical medical instruments.

REVISION HISTORY SHEET				
Rev	Table	Page	Description of Change	Date
A	T5	4	AC Characteristics Table - Added "or 2.5V±5%" to table title condition.	9/5/08
A	T4	1	Deleted HiPerClockS references.	9/23/12
		4	Crystal Characteristics Table - added note.	
		8	Deleted application note, LVCMOS to XTAL Interface.	
	T9	12	Deleted quantity from tape and reel.	
A	T9	12	Ordering Information - removed leaded devices. Updated data sheet format.	10/26/15





**Corporate Headquarters**

6024 Silver Creek Valley Road  
San Jose, California 95138

**Sales**

800-345-7015 or +408-284-8200  
Fax: 408-284-2775  
www.IDT.com

**Technical Support**

**email: [clocks@idt.com](mailto:clocks@idt.com)**

DISCLAIMER Integrated Device Technology, Inc. (IDT) and its subsidiaries reserve the right to modify the products and/or specifications described herein at any time and at IDT's sole discretion. All information in this document, including descriptions of product features and performance, is subject to change without notice. Performance specifications and the operating parameters of the described products are determined in the independent state and are not guaranteed to perform the same way when installed in customer products. The information contained herein is provided without representation or warranty of any kind, whether express or implied, including, but not limited to, the suitability of IDT's products for any particular purpose, an implied warranty of merchantability, or non-infringement of the intellectual property rights of others. This document is presented only as a guide and does not convey any license under intellectual property rights of IDT or any third parties.

IDT's products are not intended for use in applications involving extreme environmental conditions or in life support systems or similar devices where the failure or malfunction of an IDT product can be reasonably expected to significantly affect the health or safety of users. Anyone using an IDT product in such a manner does so at their own risk, absent an express, written agreement by IDT.

Integrated Device Technology, IDT and the IDT logo are registered trademarks of IDT. Other trademarks and service marks used herein, including protected names, logos and designs, are the property of IDT or their respective third party owners.

Copyright 2015. All rights reserved.