



Chipsmall Limited consists of a professional team with an average of over 10 year of expertise in the distribution of electronic components. Based in Hongkong, we have already established firm and mutual-benefit business relationships with customers from,Europe,America and south Asia,supplying obsolete and hard-to-find components to meet their specific needs.

With the principle of “Quality Parts,Customers Priority,Honest Operation,and Considerate Service”,our business mainly focus on the distribution of electronic components. Line cards we deal with include Microchip,ALPS,ROHM,Xilinx,Pulse,ON,Everlight and Freescale. Main products comprise IC,Modules,Potentiometer,IC Socket,Relay,Connector.Our parts cover such applications as commercial,industrial, and automotives areas.

We are looking forward to setting up business relationship with you and hope to provide you with the best service and solution. Let us make a better world for our industry!



Contact us

Tel: +86-755-8981 8866 Fax: +86-755-8427 6832

Email & Skype: info@chipsmall.com Web: www.chipsmall.com

Address: A1208, Overseas Decoration Building, #122 Zhenhua RD., Futian, Shenzhen, China



› BDE Pro

Analog Drive Optimized for Crouzet Brush Motors

Speed/Torque Control | 25A Peak | 15A Continuous

Features

- › Four Quadrant Regenerative Operation
- › DIP Switch Selectable Modes
- › DIP Switch Configurable Loop Tuning
- › Selectable Inhibit Logic
- › Adjustable Current Limits
- › High Switching Frequency
- › Differential Input Command
- › Digital Fault Output Monitor
- › On-Board Test Potentiometer
- › Offset Adjustment Potentiometer
- › Adjustable Input Gain
- › Selectable 120/60 Hall Commutation Phasing
- › Encoder Velocity Mode
- › Velocity Monitor Output
- › Current Monitor Output
- › Drive Status LED



Part Number: 84855104

More Technical Features

Modes of Operation	Command Source	Feedback Supported	Motors Supported	Compliance & Agency Approvals
<ul style="list-style-type: none">› Current› Encoder Velocity› Duty Cycle (Open Loop)	<ul style="list-style-type: none">› ± 10 V Analog	<ul style="list-style-type: none">› Hall Sensors› Incremental Encoder	<ul style="list-style-type: none">› Three Phase (Brushless)› Single Phase (Brushed, Voice Coil, Inductive Load)	<ul style="list-style-type: none">› UL› cUL› CE Class A (LVD)› CE Class A (EMC)› RoHS II

Power Range

Peak Current	25 A
Continuous Current	15 A
Supply Voltage	20 - 80 VDC

Description

The 84855104 BDE Pro is optimized to drive DC brush motors at a high switching frequency. A single red/green LED indicates operating status. The drive is fully protected against overvoltage, under-voltage, overcurrent, overheating and short circuits across motor, ground and power leads. Furthermore, the drive can interface with digital controllers or be used stand-alone, and requires only a single unregulated DC power supply. Loop gain, current limit, input gain and offset can be adjusted using 14-turn potentiometers. An offset adjusting potentiometer can also be used as an on-board input signal for testing purposes. This drive can use quadrature encoder inputs for velocity control.

For more information about the 84855104 BDE Pro please visit www.crouzet-motors.com.

Block Diagram

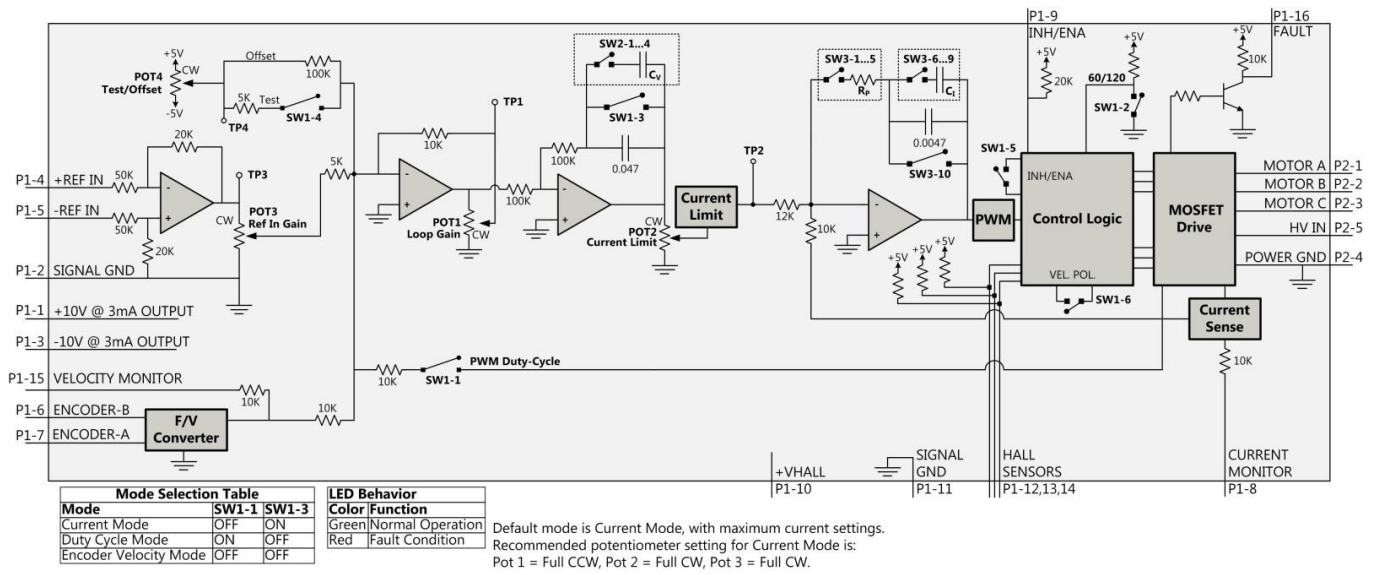

Information on Approvals and Compliances



US and Canadian safety compliance with UL 508c, the industrial standard for power conversion electronics. UL registered under file number E140173. Note that machine components compliant with UL are considered UL registered as opposed to UL listed as would be the case for commercial products.



Compliant with European EMC Directive 2004/108/EC on Electromagnetic Compatibility (specifically EN 61000-6-4:2007 for Emissions, Class A and EN 61000-6-2:2005 for Immunity, Performance Criteria A).
 LVD requirements of Directive 2006/95/EC (specifically, EN 60204-1:2004, a Low Voltage Directive to protect users from electrical shock).



The RoHS II Directive 2011/65/EU restricts the use of certain substances including lead, mercury, cadmium, hexavalent chromium and halogenated flame retardants PBB and PBDE in electronic equipment.

Specifications

Power Specifications		
Description	Units	Value
DC Supply Voltage Range	VDC	20 - 80
DC Bus Over Voltage Limit	VDC	88
DC Bus Under Voltage Limit	VDC	15
Maximum Peak Output Current ¹	A	25
Maximum Continuous Output Current	A	15
Maximum Continuous Output Power at Continuous Current	W	1140
Maximum Power Dissipation at Continuous Current	W	60
Minimum Load Inductance (Line-To-Line) ²	μH	200
Internal Bus Capacitance	μF	TBD
Low Voltage Supply Outputs	-	±10 VDC (3 mA), +6 VDC (30 mA)
Switching Frequency	kHz	22
Control Specifications		
Description	Units	Value
Command Sources	-	±10 V Analog
Feedback Supported	-	Hall Sensors, Incremental Encoder
Commutation Methods	-	Trapezoidal
Modes of Operation	-	Current, Encoder Velocity, Duty Cycle (Open Loop)
Motors Supported	-	Three Phase (Brushless), Single Phase (Brushed, Voice Coil, Inductive Load)
Hardware Protection	-	Over-Current, Over-Temperature, Over-Voltage, Under-Voltage, Short-Circuit (Phase-Phase & Phase-Ground)
Primary I/O Logic Level	-	5V TTL
Mechanical Specifications		
Description	Units	Value
Agency Approvals	-	CE Class A (EMC), CE Class A (LVD), cUL, RoHS II, UL
Size (H x W x D)	mm (in)	129.3 x 75.8 x 25.1 (5.09 x 2.98 x 0.99)
Weight	g (oz)	249.5 (8.8)
Heatsink (Base) Temperature Range ³	°C (°F)	0 - 65 (32 - 149)
Storage Temperature Range	°C (°F)	-40 - 85 (-40 - 185)
Form Factor	-	Panel Mount
P1 Connector	-	16-pin, 2.54 mm spaced, friction lock header
P2 Connector	-	5-port, 5.08 mm spaced, quick disconnect terminal

Notes

1. Maximum duration of peak current is ~2 seconds. Peak RMS value must not exceed continuous current rating of the drive.
2. Lower inductance is acceptable for bus voltages well below maximum. Use external inductance to meet requirements.
3. Additional cooling and/or heatsink may be required to achieve rated performance.

Pin Functions

P1 - Signal Connector			
Pin	Name	Description / Notes	I/O
1	+10V 3mA OUT	±10 V @ 3 mA low power supply for customer use. Short circuit protected. Reference ground common with signal ground.	O
2	SIGNAL GND		GND
3	-10V 3mA OUT		O
4	+REF IN	Differential Reference Input (±10 V Operating Range, ±15 V Maximum Input)	I
5	-REF IN		I
6	ENCODER-B IN	Single-ended encoder channel B input. +5 V logic level.	I
7	ENCODER-A IN	Single-ended encoder channel A input. +5 V logic level.	I
8	CURRENT MONITOR	Current Monitor. Analog output signal proportional to the actual current output. Scaling is 4.4 A/V. Measure relative to signal ground.	O
9	INHIBIT / ENABLE	TTL level (+5 V) inhibit/enable input. Pull to ground to inhibit drive (SW1-5 ON). Pull to ground to enable drive (SW1-5 OFF). Inhibit turns off all power devices.	I
10	+V HALL 30mA OUT	Low Power Supply for Hall Sensors (+6 V @ 30 mA). Referenced to signal ground. Short circuit protected.	O
11	GND	Signal Ground	GND
12	HALL 1	Single-ended Hall/Commutation Sensor Inputs (+5 V logic level). Leave open for brushed motors.	I
13	HALL 2		I
14	HALL 3		I
15	VEL MONITOR OUT	Velocity Monitor. Analog output proportional to motor speed. In Encoder Velocity mode, output is proportional to the encoder line frequency. Encoder Velocity scaling is 22 kHz/V.	O
16	FAULT OUT	TTL level (+5 V) output becomes high when power devices are disabled due to at least one of the following conditions: inhibit, invalid Hall state, output short circuit, over voltage, over temperature, power-up reset.	O

P2 - Power Connector			
Pin	Name	Description / Notes	I/O
1	A	Motor Phase A	O
2	B	Motor Phase B	O
3	C	Motor Phase C (leave open for brushed motors)	O
4	POWER GND	Power Ground (Common with Signal Ground)	PGND
5	HIGH VOLTAGE	DC Power Input	I

Hardware Settings

Configuration Switch Functions			
SW1	Description	On Setting	Off Setting
1	Duty Cycle mode selector. Activates internal PWM feedback. OFF by default.	Duty Cycle mode	Other modes
2	60/120 degree commutation phasing setting. ON by default. For brushed motors, set to 60-degree phasing.	120 degrees	60 degrees
3	Outer loop integration. Activates or deactivates integration. ON for current mode and OFF for other modes. ON by default.	Inactive	Active
4	Test/Offset. Switches the function of the Test/Offset pot between an on-board command input for testing or a command offset adjustment. OFF by default.	Test	Offset
5	Inhibit logic. Sets the logic level of inhibit pins. ON by default.	Drive Inhibit is active low	Drive Inhibit is active high
6	Velocity feedback polarity. Changes the polarity of the internal feedback signal and the velocity monitor output signal. Inversion of the feedback polarity may be required to prevent a motor run- away condition. ON by default.	Standard	Inverted

Mode Selection Table			
Mode	SW1-1	SW1-3	Encoder
CURRENT	OFF	ON	Not Connected
DUTY CYCLE	ON	OFF	Not Connected
ENCODER VELOCITY*	OFF	OFF	Connected

Notes

1. Use SW1-6 to change the feedback polarity if necessary. This may be required to prevent a run-away condition.

Potentiometer Functions		
Potentiometer	Description	Turning CW
1	Loop gain adjustment for duty cycle / velocity modes. Turn this pot fully CCW in current mode.	Increases gain
2	Current limit. It adjusts both continuous and peak current limit while maintaining their ratio.	Increases limit
3	Reference gain. Adjusts the ratio between input signal and output variables (voltage, current, or velocity).	Increases gain
4	Offset / Test. Used to adjust any imbalance in the input signal or in the amplifier. Can also be used as an on-board signal source for testing purposes.	Adjusts offset in negative direction

Notes

1. Note: Potentiometers are approximately linear and have 12 active turns with 1 inactive turn on each end. Test points are provided on the drive PCB near each potentiometer to measure the potentiometer value.

Actuating the Switches



To turn on a switch, use a tool such as a small screwdriver to gently push the switch forward



To turn off a switch, use a tool such as a small screwdriver to gently pull the switch backward. *Tip: use the underside of the cover as a fulcrum and the screwdriver as a lever to pull the switch backward*

Loop Tuning Switch Functions

In general, the drive will not need to be further tuned beyond the default configuration. However, for applications requiring more precise tuning, DIP switches can be used to adjust the current and velocity loop tuning values. Some general rules of thumb to follow when tuning the drive are:

- A larger resistor value will increase the proportional gain, and therefore create a faster response time.
 - A larger capacitor value will increase the integration time, and therefore create a slower response time.
- Proper tuning will require careful observation of the loop response on a digital oscilloscope to find optimal DIP switch settings for the specific application.

(Note: Drive cover must be removed to access SW2 and SW3)

SW2 DIP switches 1-4 add additional parallel capacitance to the velocity loop integrator capacitor (see Block Diagram). The resulting velocity loop capacitance values are given in the table below along with the appropriate DIP switch settings. By default, all SW2 switches are OFF (shaded in the SW2 table below).

SW2 - Velocity Loop Integrator Capacitance Options (uF)																
Switch	.047	147	.267	.367	.517	.617	.737	.837	1.047	1.147	1.267	1.367	1.517	1.617	1.737	1.837
SW2-1	OFF	ON	OFF	ON	OFF	ON	OFF	ON	OFF	ON	OFF	ON	OFF	ON	OFF	ON
SW2-2	OFF	OFF	ON	ON	OFF	OFF	ON	ON	OFF	OFF	ON	ON	OFF	OFF	ON	ON
SW2-3	OFF	OFF	OFF	OFF	ON	ON	ON	ON	OFF	OFF	OFF	OFF	ON	ON	ON	ON
SW2-4	OFF	OFF	OFF	OFF	OFF	OFF	OFF	OFF	ON	ON	ON	ON	ON	ON	ON	ON

Notes

1. The velocity loop integrator capacitor can be shorted entirely by setting SW1-3 to OFF.

SW3 DIP switches add additional resistance and capacitance to the current loop tuning circuitry. SW3 switches 1-5 add additional series resistance to the current loop gain resistor, and SW3 switches 6-10 add additional parallel capacitance to the current loop integrator capacitor (see Block Diagram). The resulting capacitance and resistance values are given in the tables below along with the appropriate DIP switch settings. The default switch settings are shaded in the SW3 tables below.

SW3 - Current Loop Proportional Gain Resistance Options (kΩ)																
Switch	10	20	30	40	50	60	70	80	90	100	110	120	130	140	150	160
SW3-1	ON	OFF	ON	OFF	ON	OFF	ON	OFF	ON	OFF	ON	OFF	ON	OFF	ON	OFF
SW3-2	ON	ON	OFF	OFF	ON	ON	OFF	OFF	ON	ON	OFF	OFF	ON	ON	OFF	OFF
SW3-3	ON	ON	ON	ON	OFF	OFF	OFF	OFF	ON	ON	ON	ON	OFF	OFF	OFF	OFF
SW3-4	ON	ON	ON	ON	ON	ON	ON	ON	OFF	OFF	OFF	OFF	OFF	OFF	OFF	OFF
SW3-5	ON	ON	ON	ON	ON	ON	ON	ON	ON	ON	ON	ON	ON	ON	ON	ON
Switch	170	180	190	200	210	220	230	240	250	260	270	280	290	300	310	320
SW3-1	ON	OFF	ON	OFF	ON	OFF	ON	OFF	ON	OFF	ON	OFF	ON	OFF	ON	OFF
SW3-2	ON	ON	OFF	OFF	ON	ON	OFF	OFF	ON	ON	OFF	OFF	ON	ON	OFF	OFF
SW3-3	ON	ON	ON	ON	OFF	OFF	OFF	OFF	ON	ON	ON	ON	OFF	OFF	OFF	OFF
SW3-4	ON	ON	ON	ON	ON	ON	ON	ON	OFF	OFF	OFF	OFF	OFF	OFF	OFF	OFF
SW3-5	OFF	OFF	OFF	OFF	OFF	OFF	OFF	OFF	OFF	OFF	OFF	OFF	OFF	OFF	OFF	OFF

SW3 - Current Loop Integrator Capacitance Options (uF)																	
Switch	.0047	0094	.0247	.0294	.0517	.0564	.0717	.0764	.0987	.1034	.1187	.1234	.1457	.1504	.1647	.1694	SHORT
SW3-6	OFF	ON	OFF	ON	OFF	ON	OFF	ON	OFF	ON	OFF	ON	OFF	ON	OFF	ON	ON
SW3-7	OFF	OFF	ON	ON	OFF	OFF	ON	ON	OFF	OFF	ON	ON	OFF	OFF	ON	ON	ON
SW3-8	OFF	OFF	OFF	OFF	ON	ON	ON	ON	OFF	OFF	OFF	OFF	ON	ON	ON	ON	ON
SW3-9	OFF	OFF	OFF	OFF	OFF	OFF	OFF	OFF	ON	ON	ON	ON	ON	ON	ON	ON	ON
SW3-10	OFF	OFF	OFF	OFF	OFF	OFF	OFF	OFF	OFF	OFF	OFF	OFF	OFF	OFF	OFF	OFF	ON

Mechanical Information

P1 - Signal Connector		
Recommended cable size		22-30AWG
Connector Information		16-pin, 2.54 mm spaced, friction lock header
Mating Connector	Details	Molex: P/N 22-01-3167 (connector) and P/N 08-50-0114 (insert terminals)
	Included with Drive	Yes

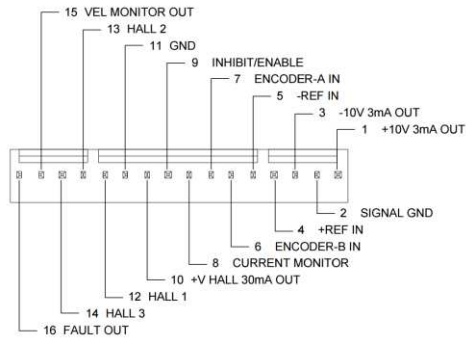

P2 - Power Connector		
Recommended cable size		12-30AWG
Connector Information		5-port, 5.08 mm spaced, quick-disconnect terminal
Mating Connector	Details	Phoenix: P/N 1911994
	Included with Drive	Yes

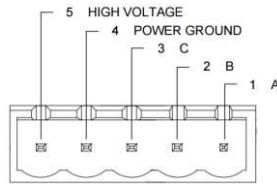

Mounting Dimensions

Mounting Dimensions: 84855104

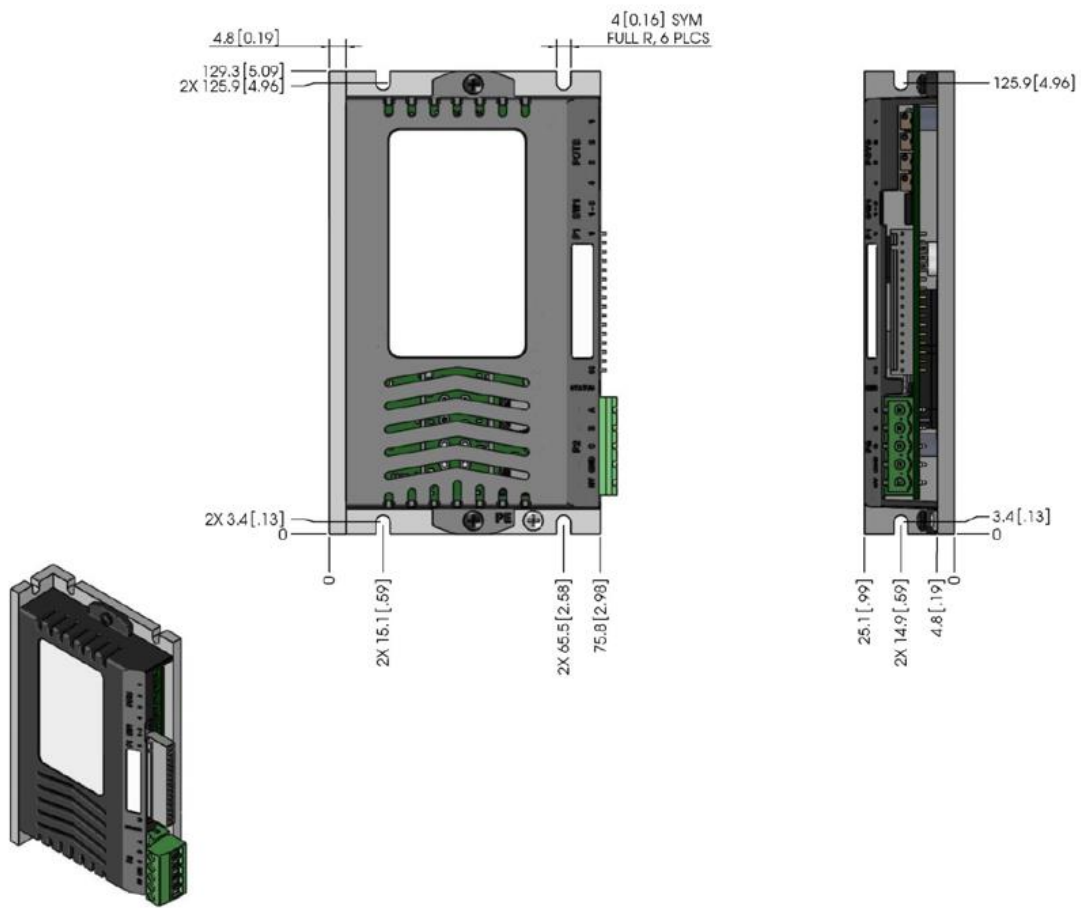

Related Products

Pre-Tuned for these Motors

DCmind Brush 42mm

15W
89 810 908

DCmind Brush 42mm

24W
89 800 908

DCmind Brush 42mm

35W
89 850 908

DCmind Brush 62mm

57W
89 830 912

DCmind Brush 62mm

100W
89 890 911

Notes

DCmind motor range is perfect for applications where silence, long life, efficiency and low EMC levels are required. They can also be provided with gearboxes.

These products are certified by:

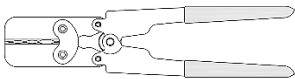

Recommended Tools

Hand Crimp Tool (economy)	
	
Details	Molex: P/N 0638111000
Description	Hand Crimper Tool Rectangular Contacts, 14-24 AWG Side Entry

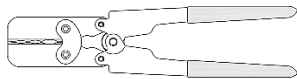
Hand Crimp Tool (premium)	
	
Details	Molex: P/N 0638118200
Description	Hand Crimper Tool Rectangular Contacts, 22-30 AWG Side Entry, Ratchet

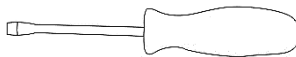
Screwdriver	
	
Details	Wiha: P/N 96015
Description	Screwdriver Slotted 1.5mm

Settings Optimized for Crouzet Motors

Duty Cycle Mode

When speed control is needed without precision and load is fairly constant. No encoder feedback or external controller is necessary.

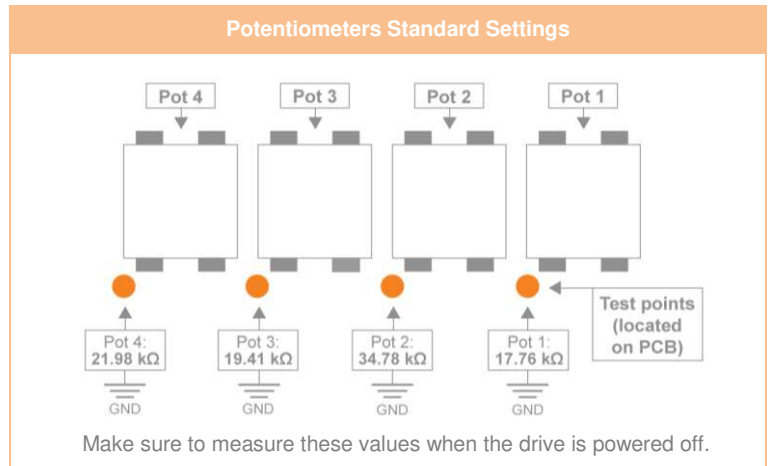
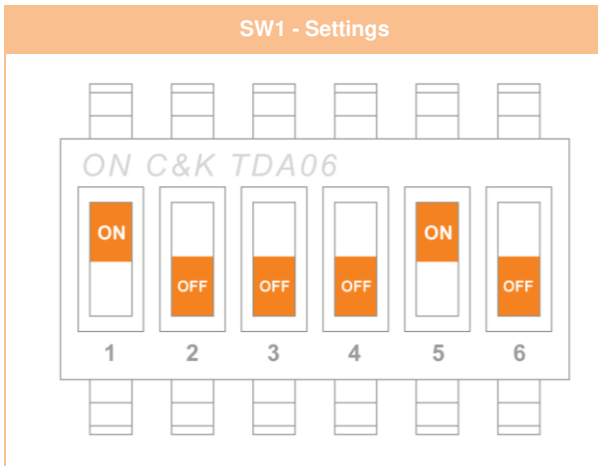

Notes: Settings for Crouzet DCmind Brush + Encoder (89810908, 89800908, 89850908, 89830912, 89890911) up to a nominal load. If your application is outside these conditions, please refer to the information on this datasheet or contact Crouzet tech support for assistance.

Encoder Velocity Mode

When precise speed control is needed and load is fairly constant. Encoder feedback is necessary and external controller could be used if desired, but is not necessary

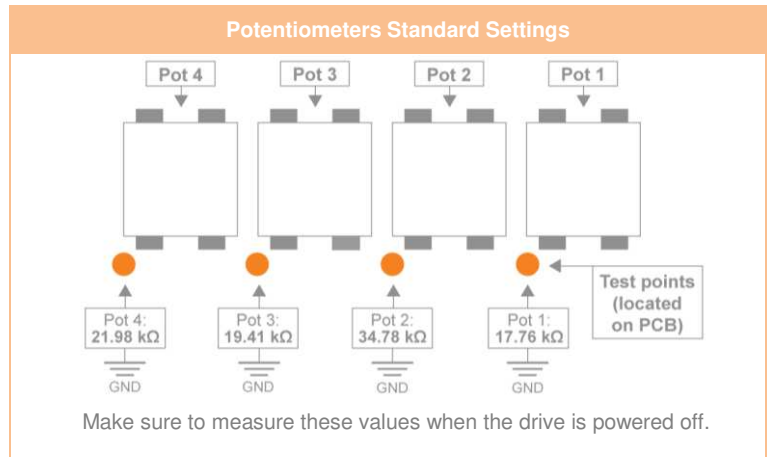
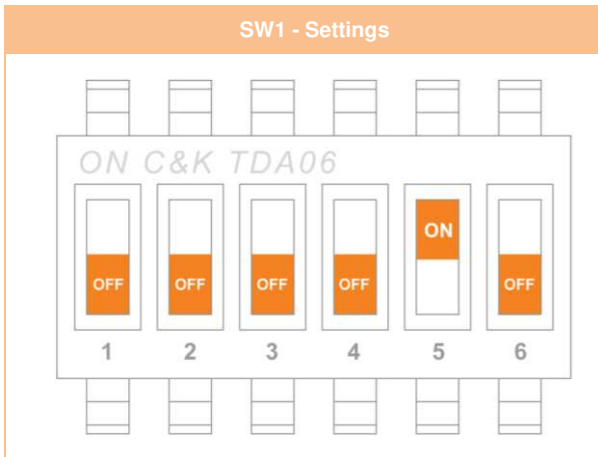

Notes: Settings for Crouzet DCmind Brush + Encoder (89810908, 89800908, 89850908, 89830912, 89890911) and up to a nominal load. If your application is outside these conditions, please refer to the information on this datasheet or contact Crouzet tech support for assistance.

All specifications in this document are subject to change without written notice. Actual product may differ from pictures provided in this document.