



Chipsmall Limited consists of a professional team with an average of over 10 year of expertise in the distribution of electronic components. Based in Hongkong, we have already established firm and mutual-benefit business relationships with customers from,Europe,America and south Asia,supplying obsolete and hard-to-find components to meet their specific needs.

With the principle of “Quality Parts,Customers Priority,Honest Operation,and Considerate Service”,our business mainly focus on the distribution of electronic components. Line cards we deal with include Microchip,ALPS,ROHM,Xilinx,Pulse,ON,Everlight and Freescale. Main products comprise IC,Modules,Potentiometer,IC Socket,Relay,Connector.Our parts cover such applications as commercial,industrial, and automotives areas.

We are looking forward to setting up business relationship with you and hope to provide you with the best service and solution. Let us make a better world for our industry!



Contact us

Tel: +86-755-8981 8866 Fax: +86-755-8427 6832

Email & Skype: info@chipsmall.com Web: www.chipsmall.com

Address: A1208, Overseas Decoration Building, #122 Zhenhua RD., Futian, Shenzhen, China



iMcV-DS3/E3/STS- LineTerm

Operation Manual



FCC Radio Frequency Interference Statement

This equipment has been tested and found to comply with the limits for a Class B computing device, pursuant to Part 15 of the FCC Rules. These limits are designed to provide reasonable protection against harmful interference when the equipment is operated in a commercial environment. This equipment generates, uses and can radiate radio frequency energy and, if not installed and used in accordance with the instruction manual, may cause harmful interference to radio communications. Operation of this equipment in a residential area is likely to cause harmful interference in which the user will be required to correct the interference at his own expense.

Any changes or modifications not expressly approved by the manufacturer could void the user's authority to operate the equipment.

The use of non-shielded I/O cables may not guarantee compliance with FCC RFI limits. This digital apparatus does not exceed the Class B limits for radio noise emission from digital apparatus set out in the Radio Interference Regulation of the Canadian Department of Communications.

Le présent appareil numérique n'émet pas de bruits radioélectriques dépassant les limites applicables aux appareils numériques de classe B prescrites dans le Règlement sur le brouillage radioélectrique publié par le ministère des Communications du Canada.

Limited Lifetime Warranty

Effective for products of B&B Electronics shipped on or after May 1, 2013, B&B Electronics warrants that each such product shall be free from defects in material and workmanship for its lifetime. This limited lifetime warranty is applicable solely to the original user and is not transferable.

This warranty is expressly conditioned upon proper storage, installation, connection, operation and maintenance of products in accordance with their written specifications.

Pursuant to the warranty, within the warranty period, B&B Electronics, at its option will:

1. Replace the product with a functional equivalent;
2. Repair the product; or
3. Provide a partial refund of purchase price based on a depreciated value.

Products of other manufacturers sold by B&B Electronics are not subject to any warranty or indemnity offered by B&B Electronics, but may be subject to the warranties of the other manufacturers.

Notwithstanding the foregoing, under no circumstances shall B&B Electronics have any warranty obligations or any other liability for: (i) any defects resulting from wear and tear, accident, improper use by the buyer or use by any third party except in accordance with the written instructions or advice of the B&B Electronics or the manufacturer of the products, including without limitation surge and overvoltage conditions that exceed specified ratings, (ii) any products which have been adjusted, modified or repaired by any party other than B&B Electronics or (iii) any descriptions, illustrations, figures as to performance, drawings and particulars of weights and dimensions contained in the B&B Electronics' catalogs, price lists, marketing materials or elsewhere since they are merely intended to represent a general idea of the products and do not form part of this price quote and do not constitute a warranty of any kind, whether express or implied, as to any of the B&B Electronics' products.

THE REPAIR OR REPLACEMENT OF THE DEFECTIVE ITEMS IN ACCORDANCE WITH THE EXPRESS WARRANTY SET FORTH ABOVE IS B&B ELECTRONIC'S SOLE OBLIGATION UNDER THIS WARRANTY. THE WARRANTY CONTAINED IN THIS SECTION SHALL EXTEND TO THE ORIGINAL USER ONLY, IS IN LIEU OF ANY AND ALL OTHER WARRANTIES, EXPRESS OR IMPLIED, AND ALL SUCH WARRANTIES AND INDEMNITIES ARE EXPRESSLY DISCLAIMED, INCLUDING WITHOUT LIMITATION (I) THE IMPLIED WARRANTIES OF FITNESS FOR A PARTICULAR PURPOSE AND OF MERCHANTABILITY AND (II) ANY WARRANTY THAT THE PRODUCTS ARE DO NOT INFRINGE OR VIOLATE THE INTELLECTUAL PROPERTY RIGHTS OF ANY THIRD PARTY. IN NO EVENT SHALL B&B ELECTRONICS BE LIABLE FOR LOSS OF BUSINESS, LOSS OF USE OR OF DATA INTERRUPTION OF BUSINESS, LOST PROFITS OR GOODWILL OR OTHER SPECIAL, INCIDENTAL, EXEMPLARY OR CONSEQUENTIAL DAMAGES. B&B ELECTRONIC SHALL DISREGARD AND NOT BE BOUND BY ANY REPRESENTATIONS, WARRANTIES OR INDEMNITIES MADE BY ANY OTHER PERSON, INCLUDING WITHOUT LIMITATION EMPLOYEES, DISTRIBUTORS, RESELLERS OR DEALERS OF B&B ELECTRONIC WHICH ARE INCONSISTENT WITH THE WARRANTY, SET FORTH ABOVE.

Table of Contents

FCC Radio Frequency Interference Statement	ii
Limited Lifetime Warranty.....	ii
About the iMcV-DS3/E3/STS-LineTerm.....	1
Installation	1
Configuration.....	2
Managed Modules	2
DIP Switch Settings	4
LED Operation.....	5
Troubleshooting.....	11
Specifications.....	12
B&B Electronics Technical Support.....	13
Fiber Optic Cleaning Guidelines.....	14
Electrostatic Discharge Precautions.....	15
Safety Certifications.....	16

About the iMcV-DS3/E3/STS-LineTerm

iMcV-DS3/E3/STS-LineTerm is an SNMP manageable module that converts standard thin coax signals (DS3, E3/STS, STS) to a single-mode or multi-mode fiber signal. It performs the standard “LineTermination” (GR-820-CORE) function of these TDM-based line signals. This function transmits an Alarm Indication Signal (AIS) on the line whenever a received signal is lost. Line faults can easily be isolated to one line section and do not propagate over multiple-line sections as they do with normal line repeaters.

Each module includes one pair of BNC connectors and one pair of ST or SC fiber optic connectors. This module can be installed in any iMediaChassis or MediaChassis series, but can only be managed through a SNMP manageable iMediaChassis. DS3 Line Term modules must be configured as Host and Remote. To configure a module as a Remote, set DIP Switch #10 to ON.

In addition, it is available with single-strand fiber: iMcV-DS3/E3/STS-LineTerm BNC/SSFX modules allow two wavelengths (1310 nm and 1550 nm) to share one fiber strand, essentially doubling the capacity of installed fiber. The single-strand versions as HOST and REMOTE must have opposite transmit and receive wavelengths

iMcV-DS3/E3/STS-LineTerm modules must be deployed in pairs (one at each end of a fiber line). The data transmitted on the fiber ports can only be received and interpreted by another iMcV-DS3/E3/STS-LineTerm unit.

Installation

iMcV-DS3/E3/STS-LineTerm modules can be installed in any iMediaChassis or MediaChassis series, but can be managed only through the iMediaChassis. Each module requires one slot in the chassis. To install a module, remove the blank brackets covering the slots where the module is to be installed by removing the screws on the outside edges of the bracket. Slide the module into the chassis card guides, until the module is securely seated in the connector. Secure the module to the chassis by tightening the captive screw. Save any blanks removed during installation for future use.

NOTE

It is not recommended that the iMcV-DS3/E3/STS-LineTerm module be installed in an IE-MediaChassis/1-DC chassis (850-33100). The power source in this chassis is not isolated and cannot support positive referenced ground systems typically used in Telco environments. The IE-MediaChassis/2-DC and the iMediaChassis/6-DC are suitable alternatives.

Configuration

Proper configuration of the iMcV-DS3/E3/STS-LineTerm is required for maximum performance and reliability. The following sections describe the prerequisites and the configurations available for both managed and unmanaged modules.

Requirements

The iMcV-DS3/E3/STS-LineTerm conforms to many DS3/E3/STS-based environments. Ensure all of the relevant information about the expected installation environment is available before configuring the module. This information includes

- Distance of the coax run (450 feet Max)
- Distance of the fiber run (Must match fiber transceiver selected)
- Troubleshooting requirements

Managed Modules

The iMcV-DS3/E3/STS-LineTerm modules can be remotely managed when installed in an iMediaChassis with an SNMP management module.

NOTE

Before installing the modules, they must be configured for Host/Remote via the DIP Switches. The Master/Slave condition requires this configuration:

S1-10: ON Remote Unit Enabled (only at the REMOTE end) (Remote)

S1-10: OFF Remote Unit Disabled (only at the LOCAL end) (Host)

After the module is installed, modify the SNMP enabled features by using the iView² SNMP management software. In a managed chassis, the software settings take priority over DIP Switch settings. Ensure the software settings match the desired configuration requirements for the installation.

iView² Management Software

iView² is the B&B Electronics management software designed specifically for the B&B Electronics “iMcV” family of modules. It features a GUI and gives network managers the ability to monitor and control the manageable B&B Electronics products.

iView² is available in several versions, including WebServer version 3.0, and can also function as a snap-in module for HP OpenView Network Node Manager and other third party SNMP Management software.

iView² supports the following platforms:

- Windows 2000
- Windows XP

- Windows Vista
- Windows 7

In addition, there are Java versions of iView² for any Java-capable operating systems such as Linux.

Please see the SNMP Management Module installation guide for software configuration options.

Unmanaged Modules

Before installing the module in an unmanaged chassis, manually configure all of the desired DIP Switch selectable features.

DIP Switches

The iMcV-DS3/E3/STS-LineTerm DIP Switches are located at S1 and S2 on the PCB. The S2 DIP Switches are factory configured and must not be changed. The S1 DIP Switches provide control over the available iMcV-DS3/E3/STS-LineTerm features.

The location of the S1 DIP Switches is displayed in the following diagram:

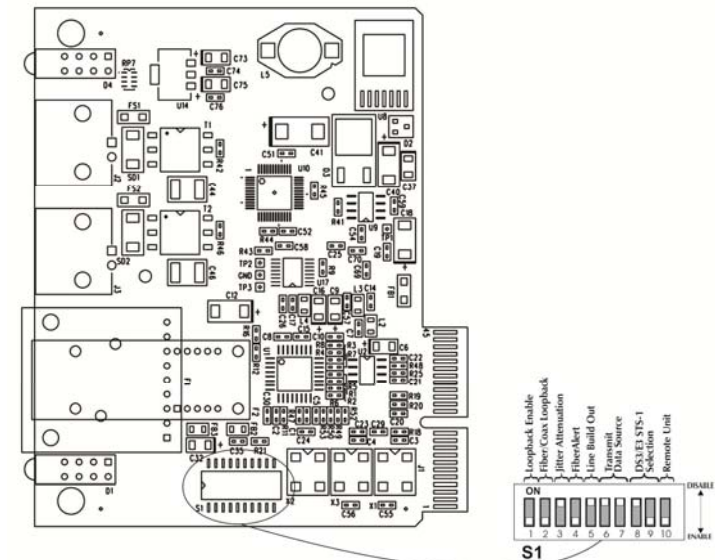

DIP Switch Settings

FUNCTION	SWITCH SETTINGS	RESULT [(D) = Default]
Loopback (iView² Configurable)	S1-1: OFF	Loopback Disabled (D)
	S1-1: ON	Loopback Enabled
Loopback Type (iView² Configurable)	S1-2: OFF	Coax (D)
	S1-2: ON	Fiber
Jitter Attenuation (iView² Configurable)	S1-3: OFF	Jitter Attenuator on Receive Side
	S1-3: ON	Jitter Attenuator on Transmit Side (D)
FiberAlert (iView² Configurable)	S1-4: OFF	FiberAlert Disabled (D)
	S1-4: ON	FiberAlert Enabled
Line Build-Out (iView² Configurable)	S1-5: OFF	0 to 255 ft.
	S1-5: ON	> 255 ft. (D)
Transmit Data Source (iView² Configurable)	S1-6: ON 7: ON	Standard Data (D)
	S1-6: OFF 7: ON	Unframed All Ones
	S1-6: ON 7: OFF	Alternating Ones & Zeros
	S1-6: OFF 7: OFF	Pseudorandom Bit Sequence
DS3/E3/STS Selection	S1-8: ON 9: OFF	45 Mbps (DS3)
	S1-8: OFF 9: ON	34 Mbps (E3)
	S1-8: ON 9: ON	52 Mbps (STS)
Remote Unit	S1-10: OFF	Remote Unit Disabled (D)
	S1-10: ON	Remote Unit Enabled

LED Operation

The iMcV-DS3/E3/STS-LineTerm module features several diagnostic LEDs per port. The LED functions are:

	<u>LEDs Next to Coax (BNC) Port</u>	
ER	Flashes yellow whenever a line code violation is received.	
LOS	Glows red when the BNC is receiving no signal and is in an LOS ALARM state, resulting in sending an RAI signal to the fiber port. If Fault Loopback is set to ON, then AIS will also be sent to the Coax line as well.	
PRBS	Glows green when the BNC port receives a valid Pseudorandom Bit Sequence. Off when the port is not receiving a Pseudorandom Bit Sequence.	
LPBK	Glows yellow when the module is in either coax or fiber loopback mode.	
	<u>LEDs Next to Fiber Optic Port</u>	
ER	Glows yellow when a fiber symbol error has been received.	
LOS	Glows red when a link is not established and is in a LOS ALARM state and will send an AIS signal to the BNC Line. If Fault Loopback is enabled, then an RAI Signal is also sent to the fiber line.	
RM	Glows green on the Remote Unit when set to DSW S1-10. Glows green on the Local unit when it has discovered a Remote management with Remote Unit enabled.	
RAI	Glows yellow when a Remote Alarm Indication is received on the fiber port. When the fiber port receives an RAI signal, this will force AIS to transmit on the COAX Line.	

Features

The iMcV-DS3/E3/STS-LineTerm module includes several features that allow it to be configured for DS3, E3/STS, or STS-based environments.

Loopback (DIP Switch S1, Position 1)

This switch enables or disables the loopback feature. When this feature is enabled, the data line (Coax or Fiber) set by the “Loopback Type” DIP Switch is looped back.

By default this feature is **DISABLED**.

This feature can be controlled by SNMP management software (iView²) when the iMcV-DS3/E3/STS-LineTerm module, configured as a HOST, is installed in a managed chassis.

Loopback Type (DIP Switch S1, Position 2)

This switch identifies which data line is looped back when the Loopback DIP Switch is enabled. The data line loopback selection can specify either a Fiber Loopback or a Coax Loopback.

By default this feature is **COAX**.

This feature can be controlled by SNMP management software (iView²) when the HOST iMcV-DS3/E3/STS-LineTerm module is installed in a managed chassis.

Fault Loopback (DIP Switch S1, Position 4)

This switch enables or disables the Fault Loopback feature. A normal fault Loss Of Signal (LOS) will cause an Alarm Indication Signal (AIS) to be sent on to the next line segment. This feature provides for a fault condition to be sent back towards the direction of the detected fault. In this way, both upstream and downstream craft personnel are alerted to a single fault.

The Fault Loopback feature uses the iMcV-DS3/E3/STS-LineTerm module LEDs to indicate that a loss of one strand of fiber has occurred. When a strand becomes unavailable, the module at the receiver-end detects the LOS of the fiber link and lights the LOS LED. The module then responds by sending a Remote Alarm Indication (RAI) signal back to the Fiber line turning ON the RAI LED at the far end of the line and sending AIS to the COAX Port. The RAI LED is now ON at the source of the Fiber fault. By using the Fault Loopback Function, a local site administrator can quickly determine where a fiber fault is located from either end of the fiber line.

The AIS is transmitted as an M13 framed all-ones signal for DS3. For E3/STS and STS, the AIS signal is an unframed all-ones pattern.

By default this feature is **ENABLED**.

This feature can be controlled by SNMP management software (iView²) when the HOST iMcV-DS3/E3/STS-LineTerm module is installed in a managed chassis.

Transmit LIU Waveshape (Line Build-Out) (DIP Switch S1, Position 5)

This switch selects the optimal transmit waveshape for the line build-out distance on the coax line. The transmit waveshape can be set for a distance of either 0 to 255 feet or over 255 feet. This feature corrects problems related to cabling (i.e., cross-talk, electromagnetic interference, etc). Improperly setting this switch will cause signal degradation.

By default this feature is set to **0 to 255 feet** (450 ft maximum).

Transmit Coax Data Source (DIP Switch S1, Positions 6 & 7)

These switches select the transmit mode used by the iMcV-DS3/E3/STS-LineTerm module. The transmit modes that can be selected include the following:

- Standard data
- Unframed All Ones (diagnostic)
- Alternating Ones and Zeros (diagnostic)
- Pseudorandom Bit Sequence (diagnostic 2¹⁵-1 PRBS Pattern)

These standard Telco transmission pattern modes are provided to help diagnose transmission errors in the line.

By default this feature is set to **STANDARD DATA**.

This feature can be controlled by SNMP-management software (iView²) when the HOST iMcV-DS3/E3/STS-LineTerm module is installed in a managed chassis.

DS3, E3/STS and STS Selection (DIP Switch S1, Position 8)

This switch selects the data rate to use on the coax line. The data rate selections available include the following:

- **DS3** (44.736 Mbps +/- 20 ppm)
- **E3/STS** (34.368 Mbps +/- 20 ppm)
- **STS** (51.840 Mbps +/- 20 ppm)

By default this feature is set to **DS3**.

This feature can be selected only by setting the DIP Switches manually.

Remote Management (DIP Switch S1, Position 10)

This switch enables or disables the Remote Management mode. Enabling Remote Management on the Remote module allows all SNMP configurable features for the Remote modules to be configured from the Host module. By default this feature is

Disabled, and the module acts as a HOST device in this default setting. This feature can be selected only by setting the DIP Switches manually.

Loopback Testing

The iMcV-DS3/E3/STS-LineTerm includes two loopback test modes: Coax Loopback and Fiber Loopback.

The following illustrations show the path that a signal takes in each of the loopback test modes.

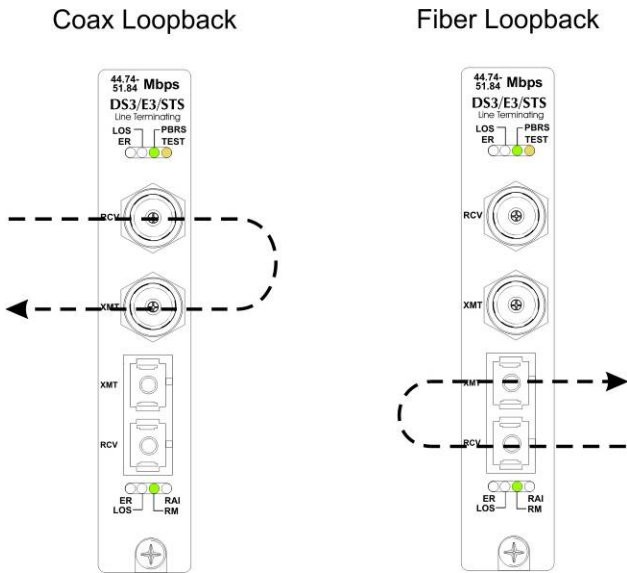

Each loopback performs the following:

- Copies the incoming signal back out to the origin while continuing to transmit this signal downstream.
- Blocks downstream data from arriving on the looped data line.

Loopback testing is useful for troubleshooting problems with network connections should they occur. Looping received data back onto the transmit path helps determine whether a connection is still valid. Remote loopback tests isolate problems on the coax run between an iMcV-DS3/E3/STS-LineTerm module and the connected device, while local loopback tests can isolate problems on the fiber connected to the module.

The following illustrations show a typical progression of loopback tests (i.e., starting by checking the coax segment at the local side, then the fiber segment at the remote side, etc.).

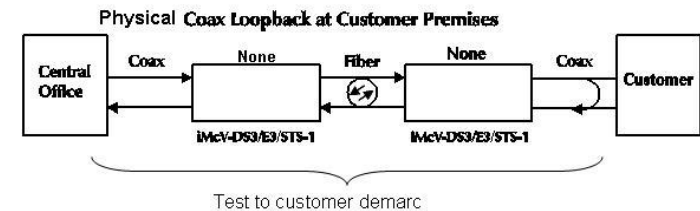
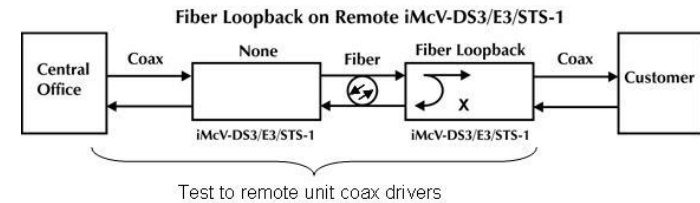
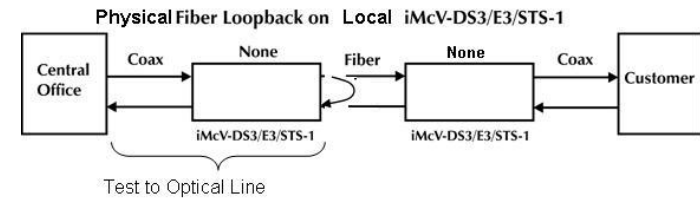
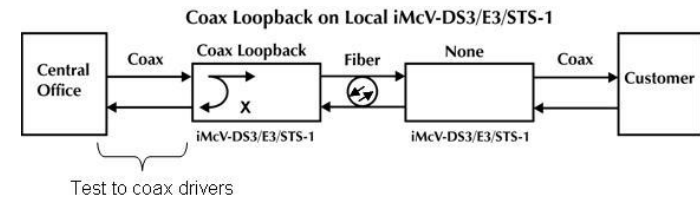

NOTE

Physical fiber loopback capability is only available when performing the loopback at the Host. The Remote unit will not loop the customer data back unless the Remote management DIP Switch #10 is set to OFF.

Pseudorandom Bit Sequence (PRBS) Testing

To test using the internal Pseudorandom Bit Sequence source, ensure that the Central Office and the Customer Premises equipment are configured for loopback. The iMcV-DS3/E3/STS-LineTerm modules should be set to normal default mode. On the HOST iMcV-DS3/E3/STS-LineTerm module, set the Transmit Coax Data Source to "Transmit Pseudorandom Sequence" (S1-6, S1-7=OFF). Verify the PRBS LED comes ON at the HOST iMcV-DS3/E3/STS-LineTerm module to validate the coax wire connections to the Central Office. Verify the PRBS LED comes ON at the REMOTE iMcV-DS3 module to validate the coax wire connections at the Customer Premises equipment and the fiber line going to the REMOTE iMcV-DS3/E3/STS-LineTerm module. The fiber line returning from the remote iMcV-DS3/E3/STS-LineTerm module is validated by verifying the RM LED is ON at the HOST iMcV-DS3/E3/STS-LineTerm module. At this point all connections for the channel have been verified.

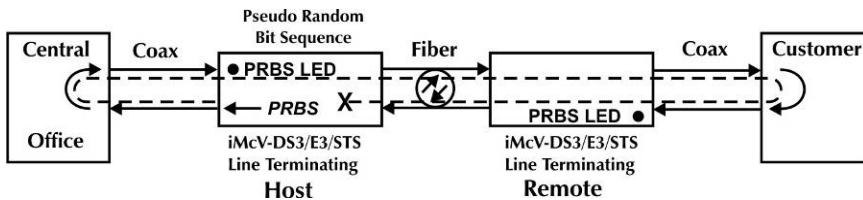

Troubleshooting

General Troubleshooting

- The Coax Port can easily be tested using the internal PRBS signal generator and detector and a physical wire loop on the coax interface.
- The Fiber Port is internally tested at all times by a working pair of units. With one unit configured for Local Management (Switch 10 set OFF) and the other for Remote Management (Switch 10 set ON), the fiber line is verified if the "RM" LED is ON at both ends of the fiber line. Under normal operation only the "RM" LED is ON at both HOST and REMOTE.
- To test a media converter by itself, first make sure you have an appropriate fiber patch cable, then follow these steps to test:
 - Connect the media converter to the BNC device with a coax cable.
 - Loop a single strand of fiber from the transmit port to the receive port of your media converter.
 - Verify that you have a valid connection for both the BNC and fiber ports on your media converter. (No "ER" or "LOS" LED ON)
- If there is trouble with link connectivity, verify your cable connection and DIP Switch setting are correct.
- Use the following LED indications to identify the fault location:

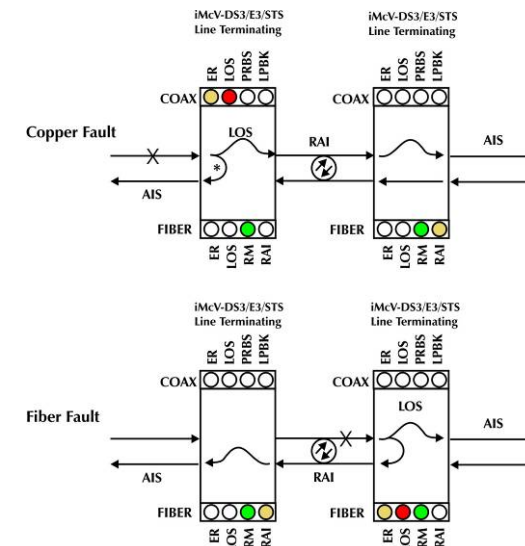

*DIP Switch 4 must be set to ON for Fault Loopback to operate as illustrated above.

Specifications

Standards Compliance (DS3, E3/STS, STS):

ANSI T1.102-1993
ANSI T1.107.1995
GR-820-CORE

DS3, E3/STS, STS Interface:

BNC coax 75 +/- 5% ohms
DS3 (44.736 Mbps +/- 20 ppm)
E3/STS (34.368 Mbps +/- 20 ppm)
STS (51.840 Mbps +/- 20 ppm)

Power Consumption (Typical):

0.550 Amps @ 5 V

Operating Temperature:

+32°F to +122°F (0°C to +50°C)

Storage Temperature:

-4°F to +158°F (-20°C to +70°C)

Humidity:

5% to 95% (non-condensing); 0 to 10,000 ft. altitude

Dimensions:

4.19" x .78" x 2.75"
(106.4 mm x 19.81 mm x 69.85 mm)

B&B Electronics Technical Support

Tel: (800) 346-3119 (in the U.S. and Canada)

Monday-Friday, 7:00am-7:00pm CST

+353 91 792444 (Europe)

Monday through Friday 8:00am - 5:00pm GMT

Fax: (815) 433-5109 U.S. and Canada

+353 91-792445 Europe

E-Mail: support@bb-elec.com U.S. and Canada

techsupport@bb-elec.com Europe

Web: www.bb-elec.com

Fiber Optic Cleaning Guidelines

Fiber Optic transmitters and receivers are extremely susceptible to contamination by particles of dirt or dust, which can obstruct the optic path and cause performance degradation. Good system performance requires clean optics and connector ferrules.

1. Use fiber patch cords (or connectors, if you terminate your own fiber) only from a reputable supplier; low-quality components can cause many hard-to-diagnose problems in an installation.
2. Dust caps are installed at B&B Electronics to ensure factory-clean optical devices. These protective caps should not be removed until the moment of connecting the fiber cable to the device. Should it be necessary to disconnect the fiber device, reinstall the protective dust caps.
3. Store spare caps in a dust-free environment such as a sealed plastic bag or box so that when reinstalled they do not introduce any contamination to the optics.
4. If you suspect that the optics have been contaminated, alternate between blasting with clean, dry, compressed air and flushing with methanol to remove particles of dirt.

Electrostatic Discharge Precautions

Electrostatic discharge (ESD) can cause damage to any product, add-in modules or stand alone units, containing electronic components. Always observe the following precautions when installing or handling these kinds of products

1. Do not remove unit from its protective packaging until ready to install.
2. Wear an ESD wrist grounding strap before handling any module or component. If the wrist strap is not available, maintain grounded contact with the system unit throughout any procedure requiring ESD protection.
3. Hold the units by the edges; do not touch the electronic components or gold connectors.
4. After removal, always place the boards on a grounded, static-free surface, ESD pad or in a proper ESD bag. Do not slide the modules or stand alone units over any surface.



WARNING! Integrated circuits and fiber optic components are extremely susceptible to electrostatic discharge damage. Do not handle these components directly unless you are a qualified service technician and use tools and techniques that conform to accepted industry practices.

Safety Certifications

UL/CUL: Listed to Safety of Information Technology Equipment, including Electrical Business Equipment.



**Class 1 Laser product, Luokan 1 Laserlaite,
Laser Klasse 1. Appareil A' Laser de Classe 1**

European Directive 2002/96/EC (WEEE) requires that any equipment that bears this symbol on product or packaging must not be disposed of with unsorted municipal waste. This symbol indicates that the equipment should be disposed of separately from regular household waste. It is the consumer's responsibility to dispose of this and all equipment so marked through designated collection facilities appointed by government or local authorities. Following these steps through proper disposal and recycling will help prevent potential negative consequences to the environment and human health. For more detailed information about proper disposal, please contact local authorities, waste disposal services, or the point of purchase for this equipment.



International Headquarters

B&B Electronics
707 Dayton Road
Ottawa, IL 61350 USA

Phone (815) 433-5100 — **General Fax** (815) 433-5105

Email: support@bb-elec.com

Website: www.bb-elec.com

European Headquarters

B&B Electronics
Westlink Commercial Park
Oranmore, Co. Galway, Ireland

Phone + 353 91-792444 — **Fax** + 353 91-79244S5

Email: techSupport@bb-elec.com

Website: www.bb-elec.com

**ISO 9001:2008
REGISTERED**



© 2013 B&B Electronics. All rights reserved.

The information in this document is subject to change without notice. B&B Electronics assumes no responsibility for any errors that may appear in this document. iMcV-DS3/E3/STS-LineTerm is a trademark of B&B Electronics. Other brands or product names may be trademarks and are the property of their respective companies.

Document Number 50-80400-00 A3

August 2013