



Chipsmall Limited consists of a professional team with an average of over 10 year of expertise in the distribution of electronic components. Based in Hongkong, we have already established firm and mutual-benefit business relationships with customers from,Europe,America and south Asia,supplying obsolete and hard-to-find components to meet their specific needs.

With the principle of “Quality Parts,Customers Priority,Honest Operation,and Considerate Service”,our business mainly focus on the distribution of electronic components. Line cards we deal with include Microchip,ALPS,ROHM,Xilinx,Pulse,ON,Everlight and Freescale. Main products comprise IC,Modules,Potentiometer,IC Socket,Relay,Connector.Our parts cover such applications as commercial,industrial, and automotives areas.

We are looking forward to setting up business relationship with you and hope to provide you with the best service and solution. Let us make a better world for our industry!



Contact us

Tel: +86-755-8981 8866 Fax: +86-755-8427 6832

Email & Skype: info@chipsmall.com Web: www.chipsmall.com

Address: A1208, Overseas Decoration Building, #122 Zhenhua RD., Futian, Shenzhen, China





86BSD

Digital Output

SPECIFICATIONS

- **Stainless steel with O-ring seal**
- **Pressure/temperature read-out**
- **Digital output**
- **ASIC calibrated**
- **Absolute, gage**
- **Cable/connector option**
- **Low power option**
- **16mm diaphragm diameter**

The 86BSD is a small profile, media compatible, piezoresistive silicon pressure sensor packaged in a 316L stainless steel housing. This 14-bit digital output pressure sensor supports I2C and SPI interface protocols, may come in a 3.3 or 5.0Vdc supply voltage and is designed for o-ring mounting. The sensing package utilizes silicone oil to transfer pressure from the 316L stainless steel diaphragm to the sensing element.

The 86BSD is designed for high performance, low pressure applications. A custom ASIC is used for temperature compensation, offset correction, and provides a digital output of 10~90% or 5~95%.

For a similar sensor with stainless steel fittings, refer to the 85BSD digital output pressure sensor.

FEATURES

- Mountable with O-ring seal
- ±0.25% Accuracy
- ±1.0 Total Error Band
- Cable/connector option
- Low power option
- I²C or SPI Interface protocols

APPLICATIONS

- Level controls
- Tank level measurement
- Corrosive fluids and gas measurement systems
- Sealed systems
- Manifold pressure measurement
- Barometric pressure measurement
- Submersible depth monitoring

STANDARD RANGES

Range	psiG	psiA	Range	BarG	BarA
0 to 001	•		0 to .07	•	
0 to 002	•				
0 to 005	•		0 to .35	•	
0 to 015	•	•	0 to 001	•	•
0 to 030	•	•	0 to 002	•	•
0 to 050	•	•	0 to 005	•	•
0 to 100	•	•	0 to 007	•	•
0 to 150	•	•	0 to 010	•	•
0 to 200	•	•	0 to 014	•	•
0 to 300	•	•	0 to 020	•	•

PERFORMANCE SPECIFICATIONS

Supply Voltage: 3.3Vdc

Ambient Temperature: 25°C (unless otherwise specified)

PARAMETERS	MIN	TYP	MAX	UNITS	NOTES
Zero Pressure Output (10% ~ 90%)		666		Count Hex	1
Zero Pressure Output (5% ~ 95%)		333		Count Hex	1
Full Scale Pressure Output (10% ~ 90%)		399A		Count Hex	1
Full Scale Pressure Output (5% ~ 95%)		3CCB		Count Hex	1
Accuracy	-0.25		0.25	%Span	2
Total Error Band	-1		1	%Span	3
Pressure Resolution	0.008			%Span	
Temperature Accuracy	-1.5		1.5	°C	4
Resolution – Temperature		0.1		°C	
Input Voltage Range	2.7	3.3	5.5	V	1
Supply Current		3		mA	
Insulation Resistance (50Vdc)	50			MΩ	5
Overpressure			2X	Rated	6
Burst Pressure			3X	Rated	7
Load Resistance (R _L)	10			KΩ	
Long Term Stability (Offset & Span)		±0.5		%Span/Year	
Compensated Temperature (≤5psi)	0		50	°C	
Compensated Temperature (≥15psi)	-20		+85	°C	
Operating Temperature	-40		+125	°C	
Storage Temperature	-40		+125	°C	8
Output Pressure Resolution			14	Bits	
Output Temperature Resolution	8		11	Bits	
Start Time to Data Ready			8.4	ms	9
Output Type	10% to 90% or 5% to 95%				
Interface Type	I ² C (ADDR, 0x28H)				
	I ² C (ADDR, 0X36H)				
	I ² C (ADDR, 0x46H)				
	SPI				
Media – Pressure	Liquids and gases compatible with 316/316L Stainless Steel				

Notes

- Measured at vacuum for absolute(A), ambient for gage(G) and sealed gage(S). Output is not ratiometric to supply voltage.
- Accuracy: combined linearity, hysteresis and repeatability.
- Total Error Band: includes calibration errors and temperature effects over the compensated range. See Figure 3.
- The deviation from a best fit straight line (BFSL) fitted to the output measured over the compensated temperature range. For errors beyond the compensated temperature range, See Figure 2.
- Between case and sensing element.
- 2X or 400psi, whichever is less. The maximum pressure that can be applied to a transducer without changing the transducer's performance or accuracy.
- 3X or 600psi, whichever is less. The maximum pressure that can be applied to a transducer without rupture of either the sensing element or transducer.
- Maximum temperature range for product with standard cable and connector is -20°C to +105°C.
- Start time to data ready is the time to get valid data after POR (Power on Reset). The time to get subsequent valid data is then specified by the response time specification.

DIMENSIONS

DIMENSIONS ARE IN INCHES [mm].

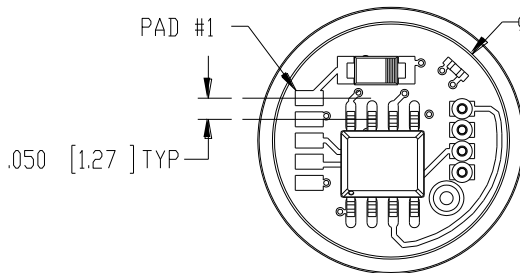
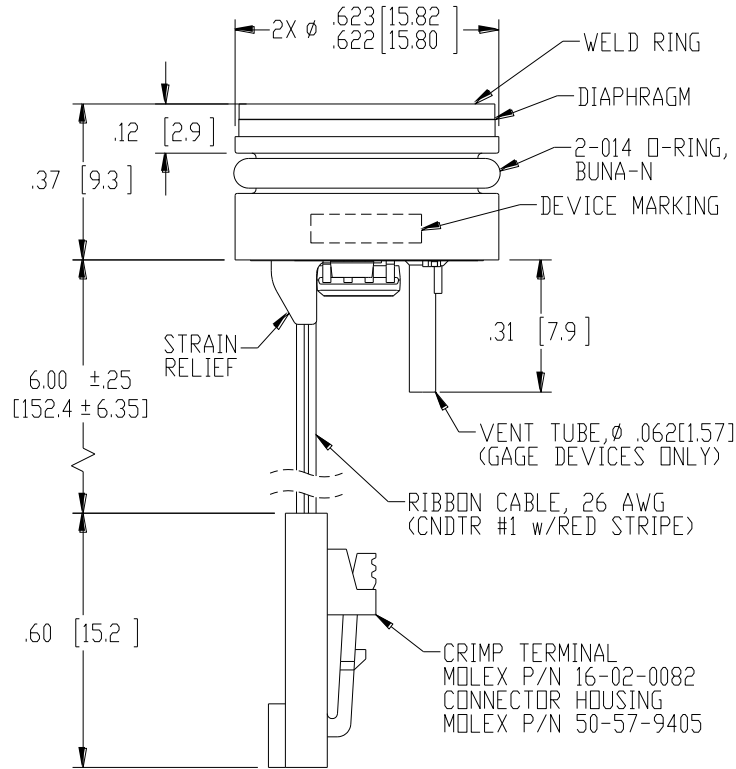

PAD/CNDR	FUNCTION
1	VDD
2	GND
3	SCL/SCLK
4	SDA/MISO
5	INT/SS

VIEW SHOWN w/o
CABLE AND CONNECTOR FOR CLARITY

BLOCK DIAGRAM

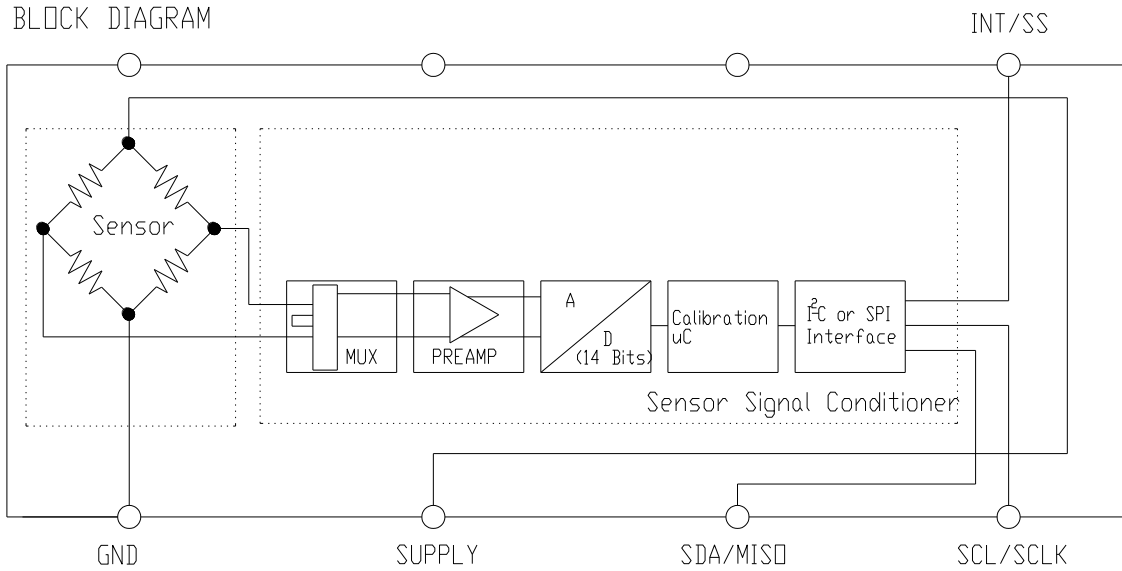

Fig 1

I2C INTERFACE PARAMETERS

PARAMETERS	SYMBOL	MIN	TYP	MAX	UNITS
SCLK CLOCK FREQUENCY	F _{SCL}	100		400	KHz
START CONDITION HOLD TIME RELATIVE TO SCL EDGE	t _{HDSTA}	0.1			µs
MINIMUM SCL CLOCK LOW WIDTH @1	t _{LOW}	0.6			µs
MINIMUM SCL CLOCK HIGH WIDTH @1	t _{HIGH}	0.6			µs
START CONDITION SETUP TIME RELATIVE TO SCL EDGE	t _{SUSTA}	0.1			µs
DATA HOLD TIME ON SDA RELATIVE TO SCL EDGE	t _{HDDAT}	0			µs
DATA SETUP TIME ON SDA RELATIVE TO SCL EDGE	t _{SUDAT}	0.1			µs
STOP CONDITION SETUP TIME ON SCL	t _{SUSTO}	0.1			µs
BUS FREE TIME BETWEEN STOP AND START CONDITION	t _{BUS}	2			µs

SPI INTERFACE PARAMETERS

PARAMETERS	SYMBOL	MIN	TYP	MAX	UNITS
SCLK CLOCK FREQUENCY	F _{SCL}	50		800	KHz
SS DROP TO FIRST CLOCK EDGE	t _{HDSS}	2.5			µs
MINIMUM SCL CLOCK LOW WIDTH @1	t _{LOW}	0.6			µs
MINIMUM SCL CLOCK HIGH WIDTH @1	t _{HIGH}	0.6			µs
CLOCK EDGE TO DATA TRANSITION	t _{CLKD}	0		0.1	µs
RISE OF SS RELATIVE TO LAST CLOCK EDGE	t _{SUSS}	0.1			µs
BUS FREE TIME BETWEEN RISE AND FALL OF SS	t _{BUS}	2			µs

@1 COMBINED LOW AND HIGH WIDTHS MUST EQUAL OR EXCEED MINIMUM SCL PERIOD.

TEMPERATURE/PRESSURE ACCURACY

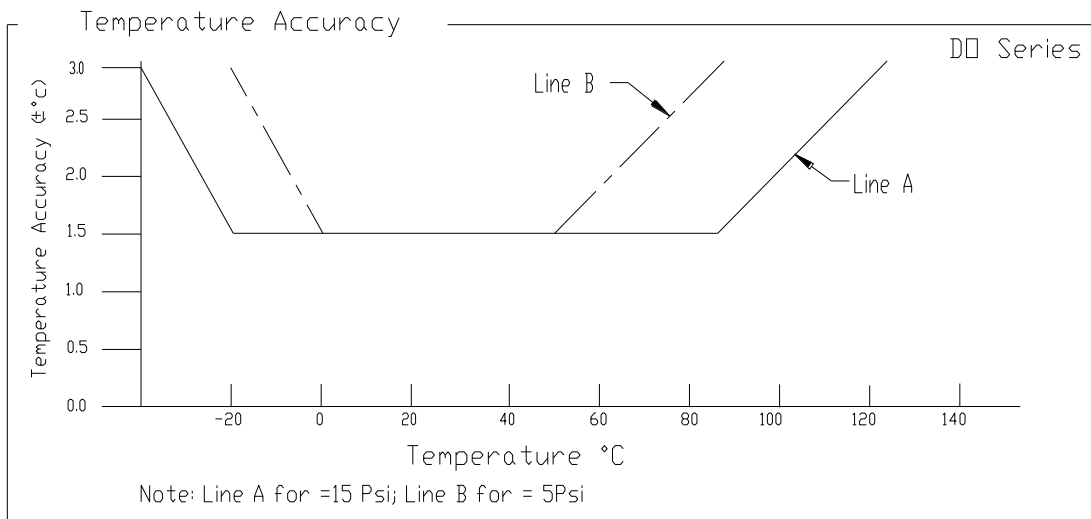

Fig 2

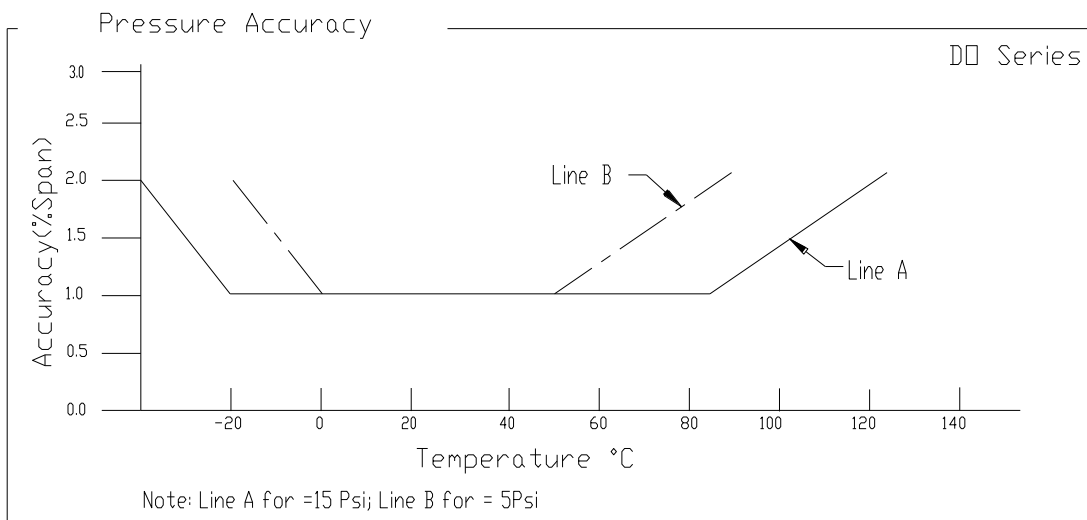

Fig 3

PRESSURE TRANSFER FUNCTIONS

Pressure Transfer Functions

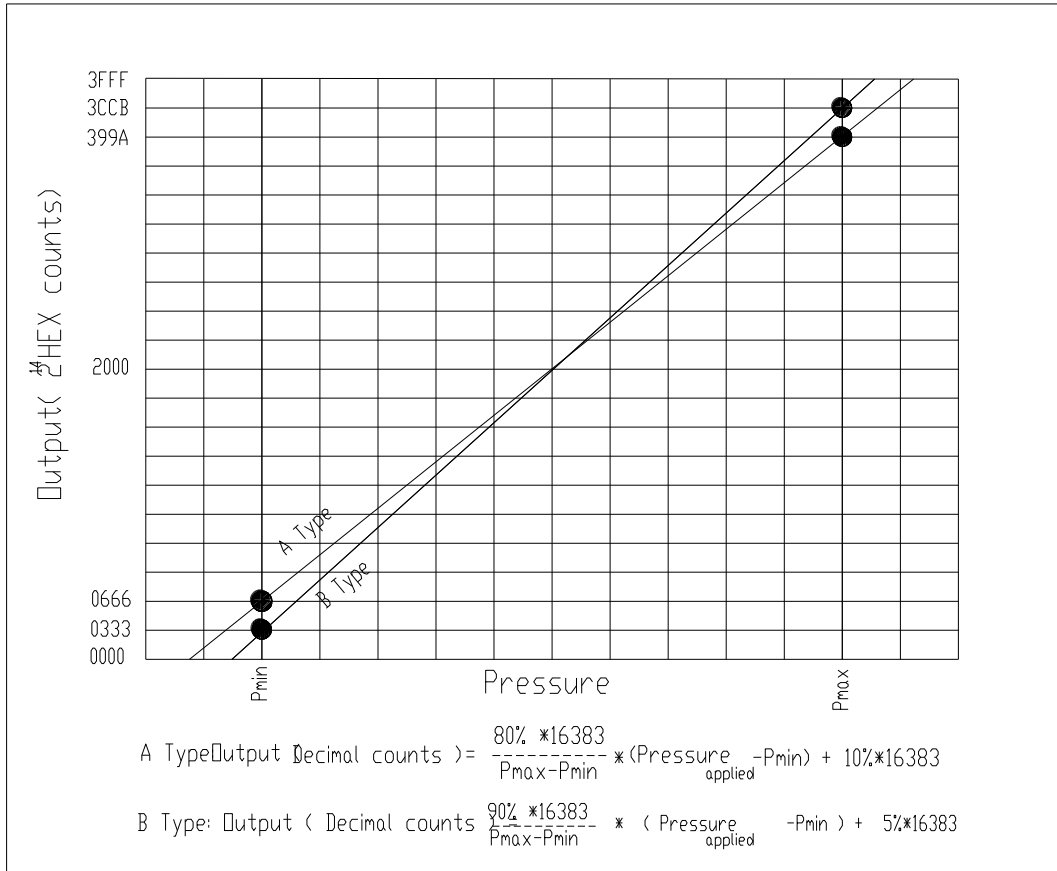

Fig 4

Sensor Output at Significant Percentages

% Output	Digital Counts (decimal)	Digital Counts (hex)
0	0	0 X 0000
5	819	0 X 0333
10	1638	0 X 0666
50	8192	0 X 2000
90	14746	0 X 399A
95	15563	0 X 3CCB
100	16383	0 X 3FFF

TEMPERATURE TRANSFER FUNCTIONS

Temperature Transfer Functions

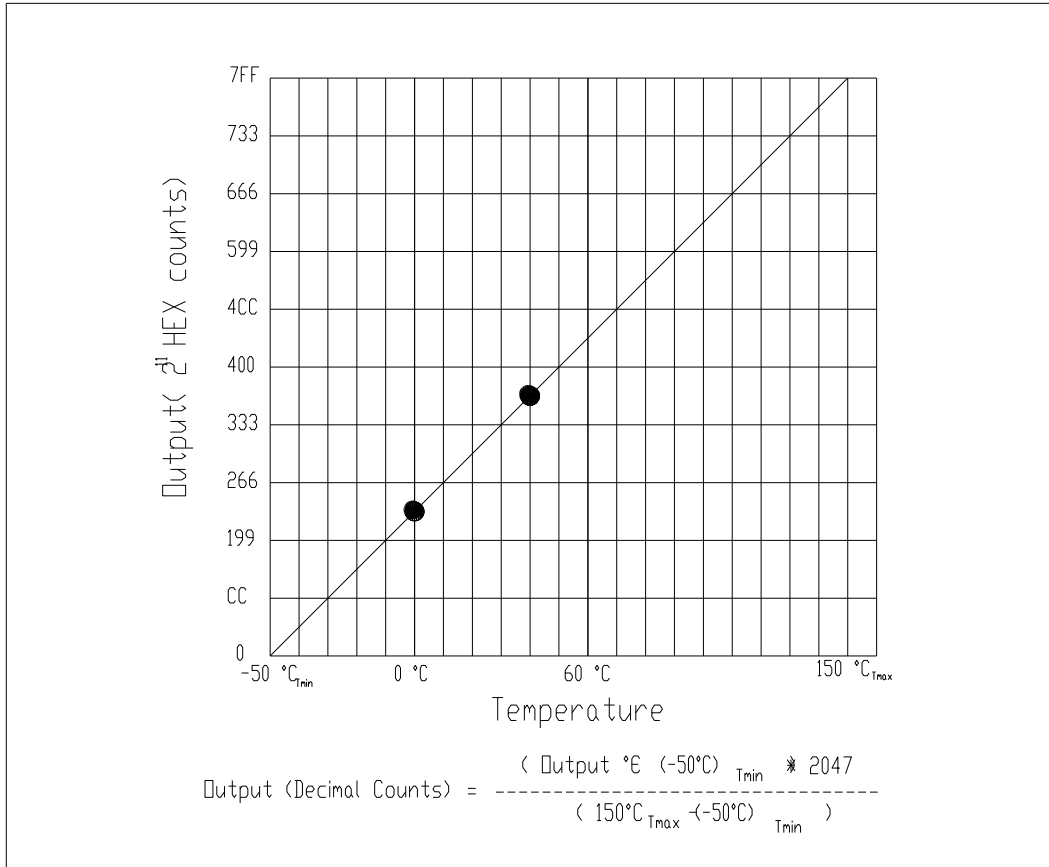
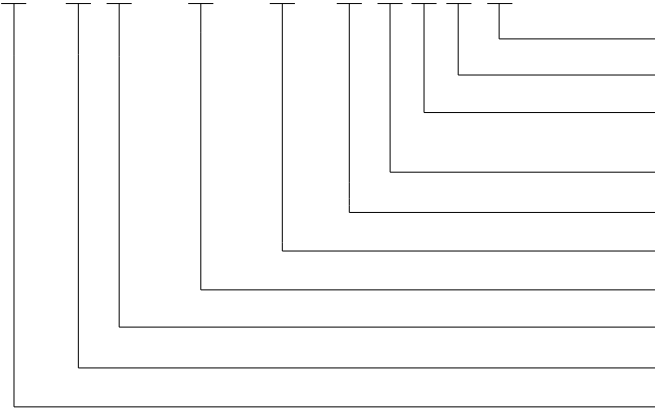

Fig 5

Temperature Output vs Counts

Output °C	Digital Counts (decimal)	Digital Counts (hex)
-50	0	0 X 0000
0	512	0 X 0200
10	614	0 X 0266
25	767	0 X 02FF
40	921	0 X 0399
85	1381	0 X 0565
150	2047	0 X 07FF

ORDERING INFORMATION**86B S D 015P A - 3 A I C L**

Low Power (Blank = None, L = Low Power)
 Connection (P = Pads, R = Ribbon Cable, C = Cable w/ Connector)
 Interface (I = I2C (ADDR. 0X28H, J = I2C (ADDR. 0X36H),
 K = I2C (ADDR. 0X46H, S = SPI)
 Output (A = 10~90%, B = 5~95%)
 Supply Voltage (3 = 3.3Vdc, 5 = 5.0Vdc)
 Type (A = Absolute, G = Gage)
 Pressure Range
 Digital Output
 Stainless Steel
 Model

NORTH AMERICA

Measurement Specialties, Inc.,
 a TE Connectivity Company
 45738 Northport Loop West
 Fremont, CA 94538
 Tel: +1 800 767 1888
 Fax: +1 510 498 1578
 e-mail: pfg.cs.amer@meas-spec.com
 Website: www.meas-spec.com

EUROPE

Measurement Specialties (Europe), Ltd.,
 a TE Connectivity Company
 26 Rue des Dames
 78340 Les Clayes-sous-Bois, France
 Tel: +33 (0) 130 79 33 00
 Fax: +33 (0) 134 81 03 59
 Sales: pfg.cs.emea@meas-spec.com

ASIA

Measurement Specialties (China), Ltd.,
 a TE Connectivity Company
 No. 26 Langshan Road
 Shenzhen High-Tech Park (North) Nanshan
 District, Shenzhen, 518057
 China
 Tel: +86 755 3330 5088
 Fax: +86 755 3330 5099
 e-mail: pfg.cs.asia@meas-spec.com
 Website: www.meas-spec.com

TE.com/sensorsolutions

Measurement Specialties, Inc., a TE Connectivity company.

Measurement Specialties, TE Connectivity, TE Connectivity (logo) and EVERY CONNECTION COUNTS are trademarks. All other logos, products and/or company names referred to herein might be trademarks of their respective owners.

The information given herein, including drawings, illustrations and schematics which are intended for illustration purposes only, is believed to be reliable. However, TE Connectivity makes no warranties as to its accuracy or completeness and disclaims any liability in connection with its use. TE Connectivity's obligations shall only be as set forth in TE Connectivity's Standard Terms and Conditions of Sale for this product and in no case will TE Connectivity be liable for any incidental, indirect or consequential damages arising out of the sale, resale, use or misuse of the product. Users of TE Connectivity products should make their own evaluation to determine the suitability of each such product for the specific application.

© 2015 TE Connectivity Ltd. family of companies All Rights Reserved.

DA5803-14BA07_000

000058033004 ECN2410