



Chipsmall Limited consists of a professional team with an average of over 10 year of expertise in the distribution of electronic components. Based in Hongkong, we have already established firm and mutual-benefit business relationships with customers from,Europe,America and south Asia,supplying obsolete and hard-to-find components to meet their specific needs.

With the principle of “Quality Parts,Customers Priority,Honest Operation,and Considerate Service”,our business mainly focus on the distribution of electronic components. Line cards we deal with include Microchip,ALPS,ROHM,Xilinx,Pulse,ON,Everlight and Freescale. Main products comprise IC,Modules,Potentiometer,IC Socket,Relay,Connector.Our parts cover such applications as commercial,industrial, and automotives areas.

We are looking forward to setting up business relationship with you and hope to provide you with the best service and solution. Let us make a better world for our industry!



Contact us

Tel: +86-755-8981 8866 Fax: +86-755-8427 6832

Email & Skype: info@chipsmall.com Web: www.chipsmall.com

Address: A1208, Overseas Decoration Building, #122 Zhenhua RD., Futian, Shenzhen, China



SN8000

Wi-Fi 802.11b/g/n Module

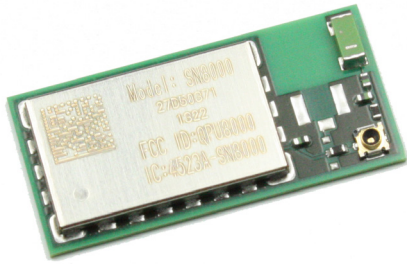

The SN8000 is a certified 2.4 GHz IEEE 802.11b/g/n Wi-Fi module based on the Broadcom BCM43362 chipset. SN8000 is designed to fit indoor and outdoor sensor and control applications. It integrates Wi-Fi IC, RF front end, temperature compensated crystal (TCXO) and an on-board antenna. The module dimensions are 24 x 11.4 x 2.0 mm.

SN8000 is enabled with Broadcom WICED™ SDK software to support low power, low cost microcontroller platforms from STM32F2/F4, Freescale K60, i.MX6, Atmel SAM4, NXP LPC17xx, NXP LPC43xx, and ZentriOS SDK.

The SN8000 module is an ideal solution for home automation, industrial control, Smart Energy, medical and healthcare applications with or without cloud services.

The module and evaluation kit are available from Murata distribution partners. A footprint compatible version with U.FL connector, SN8000UFL, is also available to connect to an external antenna.

SN8000 Module Features

- 2.4GHz IEEE 802.11b/g/n
- Chipset: Broadcom BCM43362 Wi-Fi®
- Supports WPA/WPA2 Security
- Compatible with Broadcom WICED™ SDK for STM32F2/F4, Freescale K60, i.MX6, Atmel SAM4, NXP LPC17xx, NXP LPC43xx, and ZentriOS SDK
- FCC/IC Certified, CE Compliant
- RoHS2 Compliant

SN8000 Module Application

- Home Automation & Home Energy Management
- Systems
- Smart Appliances
- Industrial Control and Monitoring
- Medical and Healthcare

Module Block Diagram

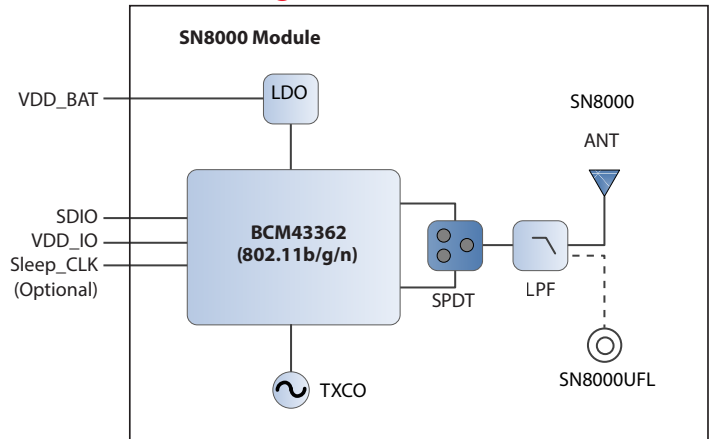

Module Specifications

Technology	2.4 GHz IEEE 802.11b/g/n
Antenna Configuration	On-board or U.FL Connector
Transmit Power	+18.5dBm @b mode/11Mbps
Max receive sensitivity	-96dBm
Host interface	SDIO
Operating temperature	-40°C to +85°C

Module Dimensions

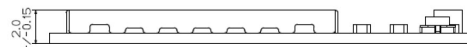
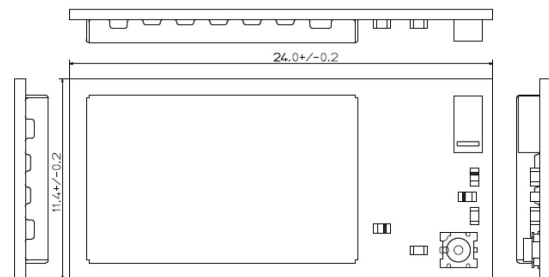

L (mm)	W (mm)	H (mm)
24.0 ±0.2	11.4 ±0.2	2.0 ±1.5



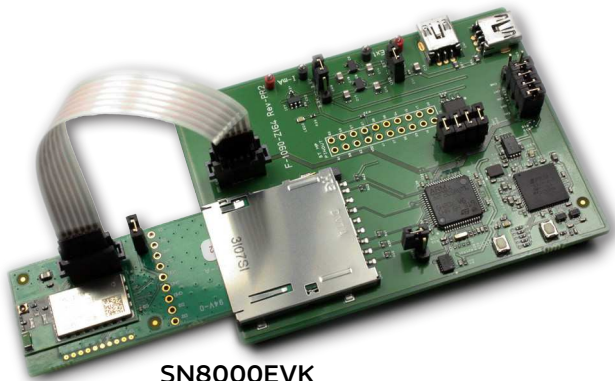

SN8000EVK
(P/N 88-00153-85 & 88-00153-87)

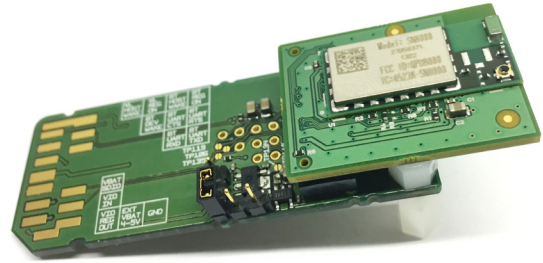

SN8000CMK
P/N 88-00153-90

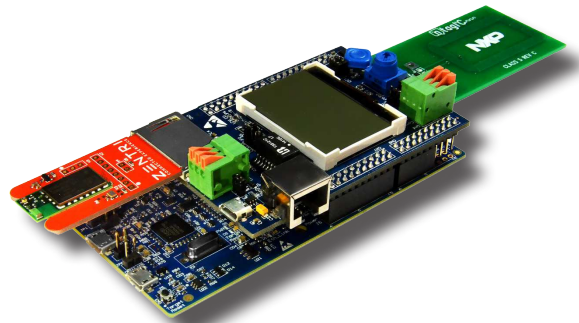

NXP/Zentri LPC43S67-A70CM Cloud Connectivity Kit
(P/N OM13086)

Item	Model Number	Ordering Part Number	Description
SN8000 module	SN8000	88-00153-00	Murata SN8000 WiFi 11n module with on-board antenna
SN8000 UFL module	SN8000UFL	88-00153-02	Murata SN8000UFL WiFi 11n module with u.FL connector
SN8000EVK	SN8000EVK	88-00153-85	Murata SN8000 module evaluation and development kit
SN8000UFL EVK	SN8000UFL EVK	88-00153-87	Murata SN8000UFL module evaluation and development kit
SN8000CMK	SN8000CMK	88-00153-90	Murata SN8000 Connector Module Kit for Freescale i.MX6 microcontroller
NXP LPC43S67-A70CM Cloud Connectivity Kit		OM13086	NXP and Zentri Cloud Connectivity Kit