



Chipsmall Limited consists of a professional team with an average of over 10 year of expertise in the distribution of electronic components. Based in Hongkong, we have already established firm and mutual-benefit business relationships with customers from,Europe,America and south Asia,supplying obsolete and hard-to-find components to meet their specific needs.

With the principle of “Quality Parts,Customers Priority,Honest Operation,and Considerate Service”,our business mainly focus on the distribution of electronic components. Line cards we deal with include Microchip,ALPS,ROHM,Xilinx,Pulse,ON,Everlight and Freescale. Main products comprise IC,Modules,Potentiometer,IC Socket,Relay,Connector.Our parts cover such applications as commercial,industrial, and automotives areas.

We are looking forward to setting up business relationship with you and hope to provide you with the best service and solution. Let us make a better world for our industry!



Contact us

Tel: +86-755-8981 8866 Fax: +86-755-8427 6832

Email & Skype: info@chipsmall.com Web: www.chipsmall.com

Address: A1208, Overseas Decoration Building, #122 Zhenhua RD., Futian, Shenzhen, China



**ebm-papst St. Georgen GmbH & Co. KG**

Hermann-Papst-Str. 1

D-78112 St. Georgen

Phone +49 (0) 7724 81-0

Fax +49 (0) 7724 81-1309

info2@de.ebmpapst.com

www.ebmpapst.com

Nominal data

Type	8880 N	
Phase		1~
Nominal voltage	VAC	230
Frequency	Hz	50
Speed (rpm)	min ⁻¹	1750
Power consumption	W	9.0
Min. ambient temperature	°C	-10
Max. ambient temperature	°C	80
Air flow	m ³ /h	30
Sound power level	B	3.3
Sound pressure level	dB(A)	18

ml = Max. load · me = Max. efficiency · fa = Free air · cs = Customer specification · ce = Customer equipment
Subject to change



Technical description

Weight	0.490 kg
Dimensions	80 x 80 x 38 mm
Impeller material	Sheet steel, painted black
Housing material	Die-cast aluminum
Part no.	9244014343
Airflow direction	Exhaust over struts
Direction of rotation	Clockwise, viewed toward rotor
Storage	Sintec sleeve bearing
Service life L10 at 40 °C	60000 h
Service life L10 at maximum temperature	25000 h
Cable	With 2 leads AWG 18, TR 64 Grounding lug M4 x 8
Motor protection	Protected from overload by impedance protection
Approval	VDE, CSA, UL, CE

Product drawing

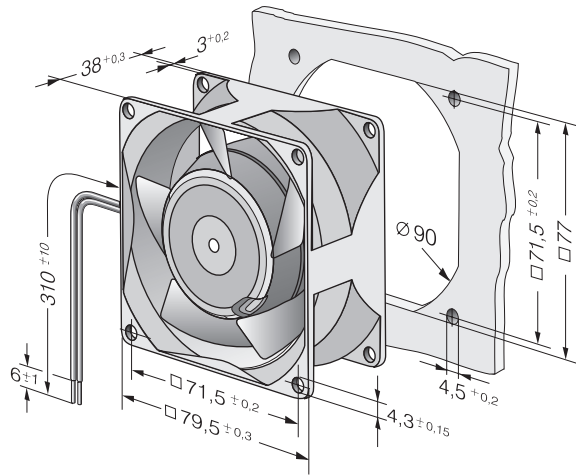

Curves: Air performance

