



Chipsmall Limited consists of a professional team with an average of over 10 year of expertise in the distribution of electronic components. Based in Hongkong, we have already established firm and mutual-benefit business relationships with customers from,Europe,America and south Asia,supplying obsolete and hard-to-find components to meet their specific needs.

With the principle of “Quality Parts,Customers Priority,Honest Operation,and Considerate Service”,our business mainly focus on the distribution of electronic components. Line cards we deal with include Microchip,ALPS,ROHM,Xilinx,Pulse,ON,Everlight and Freescale. Main products comprise IC,Modules,Potentiometer,IC Socket,Relay,Connector.Our parts cover such applications as commercial,industrial, and automotives areas.

We are looking forward to setting up business relationship with you and hope to provide you with the best service and solution. Let us make a better world for our industry!



Contact us

Tel: +86-755-8981 8866 Fax: +86-755-8427 6832

Email & Skype: info@chipsmall.com Web: www.chipsmall.com

Address: A1208, Overseas Decoration Building, #122 Zhenhua RD., Futian, Shenzhen, China



LOC		DIST		REVISIONS			
FT	8	P	LTR	DESCRIPTION	DATE	DMN	APVD
AE				REDRAWN W/O CHANGE PER EC 0020-290-96	09 DEC 97	-	-

GUIDE PIN, QTY: 2
MATERIAL: STAINLESS STEEL

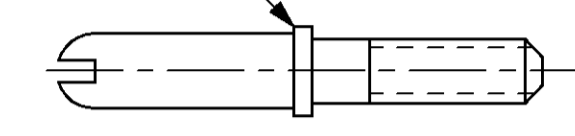

MALE BLOCK, QTY: 1
PHENOLIC, BLACK
34 POSITION

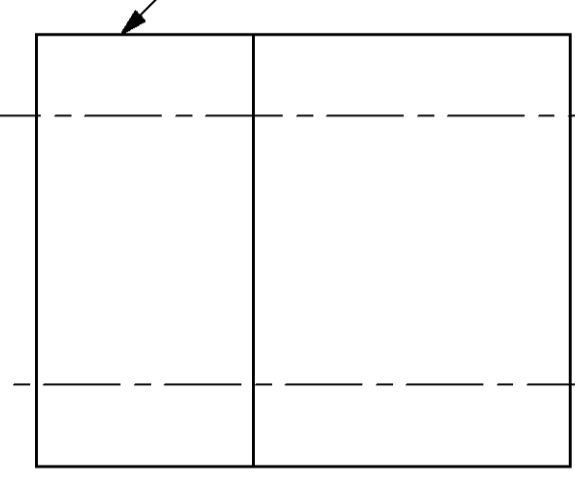

GUIDE SOCKET, QTY: 2
MATERIAL: STAINLESS STEEL

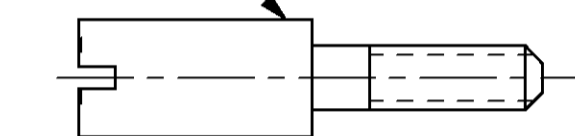

LOCK WASHER, QTY: 4
MATERIAL: STAINLESS STEEL
FINISH: PASSIVATED

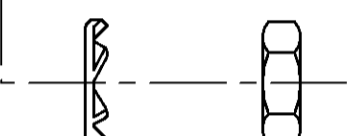

4-40 HEX NUT, QTY: 4
MATERIAL: CARBON STEEL
FINISH: ZINC PLATED

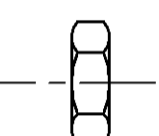

U BOLT, QTY: 1
MATERIAL: STAINLESS STEEL
FINISH: PASSIVATED

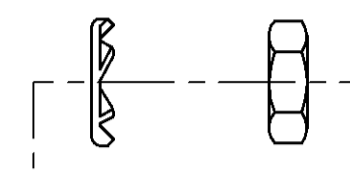

BRACKET, QTY: 1
MATERIAL: STAINLESS STEEL

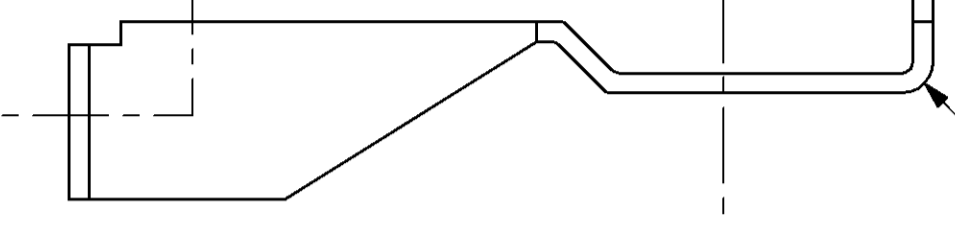

PROTECTIVE SLEEVE, QTY: 2
MATERIAL: POLYVINYL CHLORIDE

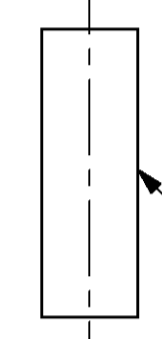

WIRE GUIDE, QTY: 1
MATERIAL: CARBON STEEL
FINISH: 5.08µm [.000200] MIN NICKEL

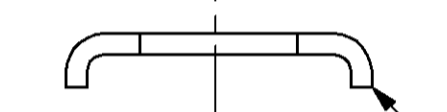

8-32 HEX NUT, QTY: 2
MATERIAL: CARBON STEEL
FINISH: ZINC PLATED

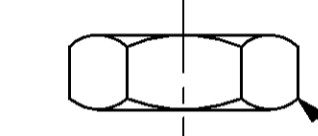

MALE JACKSCREW TIP, QTY: 1
MATERIAL: STAINLESS STEEL

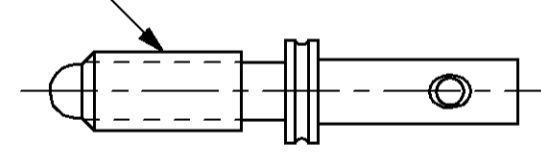

FLAT WASHER, QTY: 2
MATERIAL: STAINLESS STEEL
FINISH: PASSIVATED



JACKSCREW BODY, QTY: 2
MATERIAL: DIE CAST ZINC
FINISH: ZINC PLATED

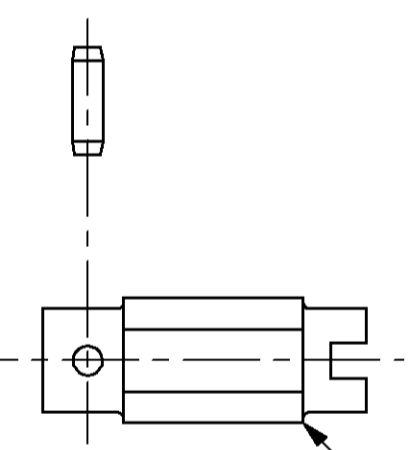

SPIROL PIN, QTY: 2
MATERIAL: STAINLESS STEEL
FINISH: PASSIVATED

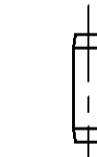

FEMALE JACKSCREW TIP, QTY: 1
MATERIAL: STAINLESS STEEL

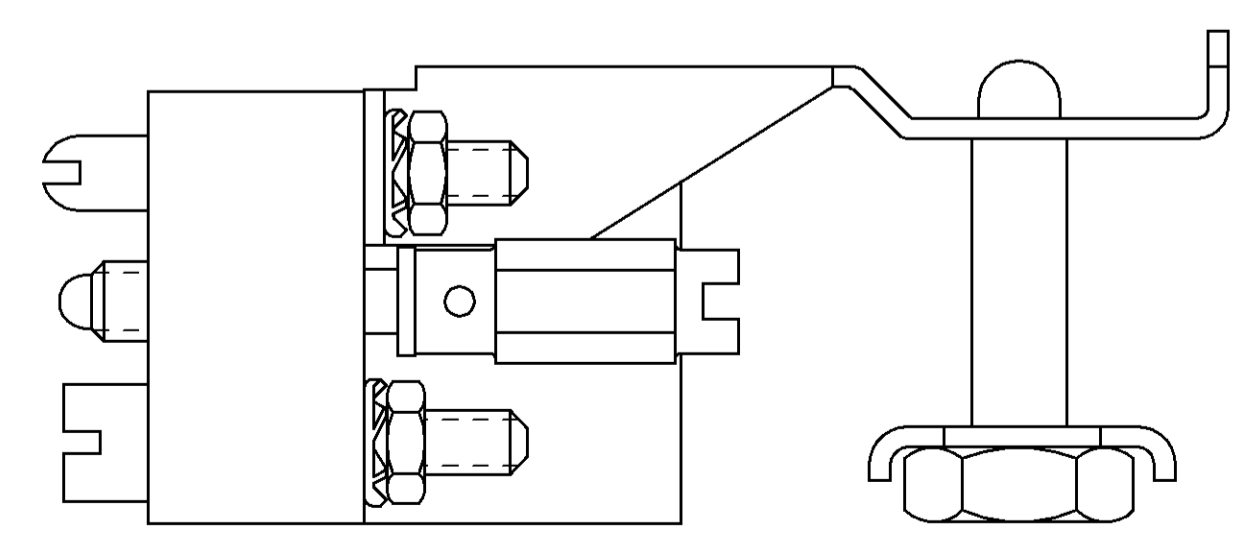
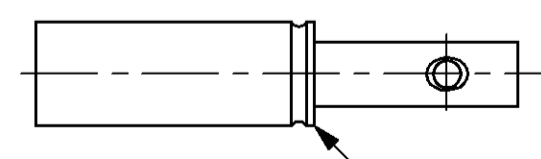

ASSEMBLED CONNECTOR KIT

9-203439-9
PART NUMBER

THIS DRAWING IS A CONTROLLED DOCUMENT.		DMN S. CARBO 09 DEC 97	AMP Incorporated Harrisburg, PA 17105-3608	
DIMENSIONS: mm (INCHES)		CHK R. STONE 23 OCT 97	NAME G. STEINHAUER 09 JAN 98	
TOLERANCES UNLESS OTHERWISE SPECIFIED:		PRODUCT SPEC		
0 PLC	±-	APPLICATION SPEC		
1 PLC	±-	SIZE		
2 PLC	+0.25 (.010)	CASE CODE		
3 PLC	±-	DRAWING NO		
4 PLC	±-	RESTRICTED TO		
ANGLES	±-	A1 00779 203439		
MATERIAL	SEE CALLOUTS	WEIGHT		
FINISH	SEE CALLOUTS	CUSTOMER DRAWING		
		SCALE 3:1		SHEET 1 OF 1
				REV AE