



Chipsmall Limited consists of a professional team with an average of over 10 year of expertise in the distribution of electronic components. Based in Hongkong, we have already established firm and mutual-benefit business relationships with customers from,Europe,America and south Asia,supplying obsolete and hard-to-find components to meet their specific needs.

With the principle of “Quality Parts,Customers Priority,Honest Operation,and Considerate Service”,our business mainly focus on the distribution of electronic components. Line cards we deal with include Microchip,ALPS,ROHM,Xilinx,Pulse,ON,Everlight and Freescale. Main products comprise IC,Modules,Potentiometer,IC Socket,Relay,Connector.Our parts cover such applications as commercial,industrial, and automotives areas.

We are looking forward to setting up business relationship with you and hope to provide you with the best service and solution. Let us make a better world for our industry!



## Contact us

Tel: +86-755-8981 8866 Fax: +86-755-8427 6832

Email & Skype: info@chipsmall.com Web: www.chipsmall.com

Address: A1208, Overseas Decoration Building, #122 Zhenhua RD., Futian, Shenzhen, China



## Features

- Complete Touchscreen Module:
  - Projected Capacitive Multi Touch Controller
  - 7in LCD
  - 4 Capacitive “Navigation” Keys
  - 200 bytes non-volatile serial EEPROM
- Touch:
  - Atmel maXTouch™ mXT768E Touch Controller
  - Supports up to 10 touches
- Display:
  - 800x480 resolution
  - ≤30 ms response time
  - White LED backlight
  - 18-bit RGB
- Navigation Keys:
  - Atmel AT42QT1070 QTouch™ Button Sensor IC
- Cover Panel:
  - 1.1mm Soda Lime Glass



## PDA TM7000: 7in PCAP Touch Module



Visit <http://www.pdaatl.com/tm7000>  
for the latest information on the TM7000

1404-3-5



## Contents

1	Module Overview	4
1.1	PCB Connections	4
1.2	Debug Connector J1	5
1.3	LCD Backlight Power J2	5
1.4	Host Connector J4	6
1.5	Host Connector J5	7
1.6	Host Interface (Combined) J6	8
1.7	Display Flex Connector J8	9
1.8	Touch Sensor Flex Connector J7	10
2	Overview of the 7in PCAP Touch Module	11
2.1	Introduction	11
2.2	Understanding Unfamiliar Concepts	12
2.3	LCD Panel	12
2.3.1	Scan Direction Selection	12
2.3.2	RGB Signal Routing	13
2.4	maXTouch Capacitive Touchscreen Controller	14
2.4.1	maXTouch Controller Interface	15
2.5	QTouch Capacitive Button Controller	15
2.5.1	QTouch Controller Interface	15
2.6	Serial EEPROM	15
3	Getting Started	16
3.1	Hardware Connections	16
3.2	Software	16
3.3	Using the Touch Module	16
3.3.1	Navigation Keys	16
3.3.2	Evaluating the Touch Module	17
4	Specifications	18
4.1	Mechanical Specifications	18
4.2	Absolute Maximum Specifications	20
4.3	Recommended Operating Conditions	20
4.4	DC Specifications	20
4.5	I2C-compatible Bus Specifications	21
4.6	Power Consumption	21
4.7	Part Number	21
5	I2C Basics (I2C-compatible Operation)	22

5.1	Interface Bus	22
5.2	Transferring Data Bits	22
5.3	START and STOP Conditions	22
5.4	Address Byte Format	23
5.5	Data Byte Format	23
5.6	Combining Address and Data Bytes into a Transmission	24
6	Revision History	25
7	Notes	26



# 1 Module Overview

## 1.1 PCB Connections

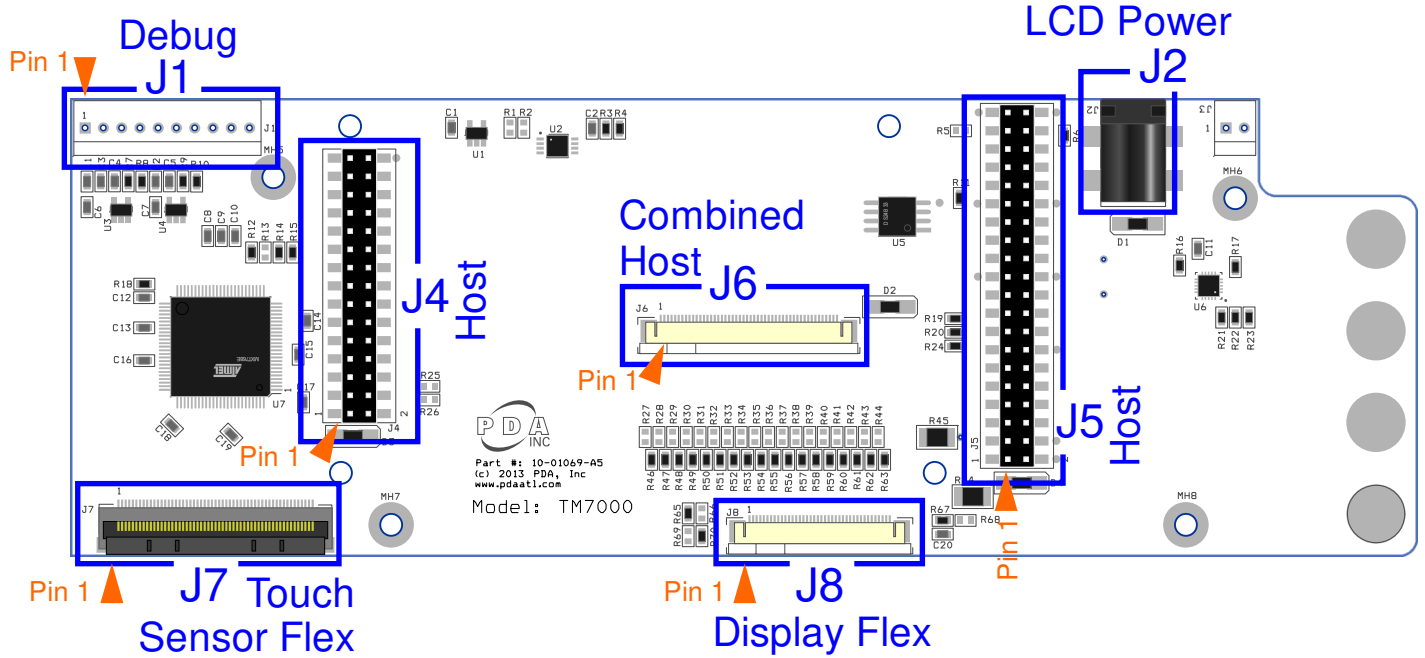

**Figure 1 - PCB Connectors**

NOTE: Insert flex in Connector J6 with contacts facing DOWN.

The following notations are used for pin descriptions:

I	Input only	OD	Open drain output
O	Output only, push-pull	P	Ground or power
MXT	maXTouch touchscreen	QT	QTouch Button Controller
EE	Serial EEPROM	LCD	LCD Panel

NOTE: Inputs and output are defined from the standpoint of the Touch Module.

## 1.2 Debug Connector J1

Connector J1 carries signals used to debug the MaXTouch Touch Controller and QTouch Button Controller.

Pin	Type	Description	MXT	QT
1	P	+5Vdc		
2	O	~QT_CHG		•
3	O	~MXT_CHG	•	
4	-	N/C		
5	I	I <sup>2</sup> C SDA	•	•

Pin	Type	Description	MXT	QT
6	I/O	I <sup>2</sup> C SCL	•	•
7	-	N/C		
8	P	GND		
9	O	DBG DATA	•	
10	O	DBG CLK	•	

## 1.3 LCD Backlight Power J2

Connector J2 is used to provide +5Vdc system and LCD backlight power to the touch module when the [Connector J6](#) host interface is being used. The host interface on connector [J6](#) only provides +3.3Vdc system power. By contrast, when the TM7000 is connected to the host via connectors [J4](#) and [J5](#), system power and LCD backlight power is provided through those interfaces.



**NOTE: J2 should NOT be used when J4 and J5 are in use.**

The mating connector for J2 is a 2.1mm I.D x 5.5mm O.D barrel connector (center positive). A +5Vdc supply rated for 1A minimum should be connected to J2.

Suggested power supplies:

- Phihong PSC12R-050, (+5Vdc, 2A)
- Phihong PSAC05R-050(P), (+5Vdc, 1A)

## 1.4 Host Connector J4

Connector J4 connects to the host and carries signals between the host and (1) the MaXTouch Touch Controller, (2) the QTouch Button Controller and (3) LCD Panel.



**NOTE: J4 (and J5) should not be used when J6 is in use.**

**J2 should not be used when J4 (and J5) are in use.**

Pin	Type	Description	MXT	LCD	QT	EE
1	P	+3.3Vdc				
2	P	GND	•			
3	P	+3.3Vdc				
4	P	GND				
5	O	~MXT_CHG	•			
6	O	~QT_CHG			•	
7	I	I <sup>2</sup> C SCL	•		•	
8	I/O	I <sup>2</sup> C SDA	•		•	
9	P	GND				
10	I	LCD_DATA_15		•		
11	P	GND				
12	I	LCD_DATA_13		•		
13	P	GND				
14	I	LCD_DATA_14		•		
15	P	GND				

Pin	Type	Description	MXT	LCD	QT	EE
16	I	LCD_DATA_12		•		
17	P	GND				
18	I	LCD_DATA_0		•		
19	I	LCD_DATA_1		•		
20	I	LCD_DATA_2		•		
21	I	LCD_DATA_3		•		
22	I	LCD_DATA_4		•		
23	I	LCD_DATA_5		•		
24	I	LCD_DATA_6		•		
25	I	LCD_DATA_7		•		
26	I	LCD_DATA_8		•		
27	I	LCD_DATA_9		•		
28	I	LCD_DATA_10		•		
29	I	LCD_DATA_11		•		
30	P	GND				

### 1.5 Host Connector J5

Connector J5 connects to the host and carries signals between the host and (1) the LCD Panel and (2) serial EEPROM.



**NOTE: J5 (and J4) should not be used when J6 is in use.**

**J2 should not be used when J5 (and J4) are in use.**

Pin	Type	Description	MXT	LCD	QT	EE
1	P	+5Vdc				
2	P	GND				
3	P	+5Vdc				
4	P	GND				
5	I	LCD_DATA_16		•		
6	I	LCD_DATA_17		•		
7	I	LCD_DATA_18		•		
8	I	LCD_DATA_19		•		
9	I	LCD_DATA_20		•		
10	I	LCD_DATA_21		•		
11	I	LCD_DATA_22		•		
12	I	LCD_DATA_23		•		
13	P	GND				
14	P	GND				
15	I	DISP (Display Enable)		•		
16	I	Backlight PWM		•		
17	I	VSYNC		•		
18	I	HSYNC		•		
19	I	DE		•		
20	I	PCLK		•		

Pin	Type	Description	MXT	LCD	QT	EE
21	P	GND				
22	P	GND				
23	-	N/C				
24	-	N/C				
25	-	N/C				
26	-	N/C				
27	-	N/C				
28	I/O	One-Wire Interface				•
29	P	GND				
30	P	GND				
31	-	N/C				
32	-	N/C				
33	-	N/C				
34	-	N/C				
35	-	N/C				
36	O	Module Presence Detect				
37	-	N/C – See Note 1				
38	-	N/C				
39	P	GND				
40	P	GND				

Note 1: by populating R5, the touch module's ~RESET signal is accessible at this pin.



## 1.6 Host Interface (Combined) J6

Connector J6 connects to the host and carries the combined signals of [J4](#) and [J5](#). It provides an alternate interface between the host and (1) the MaXTouch Touch Controller, (2) the QTouch Button Controller, (3) LCD Panel, and (4) serial EEPROM.

When the host interface on connector J6 is used, +5Vdc system power must be provided using [Connector J2](#). See Section 1.3 for details.

Suggested Flex:

Manufacturer P/N: Würth Electronics #687 650 100 002

Description: 0.5mm pitch 50 position FFC, Length 100mm

Flex should be inserted Connector J6 with contacts facing DOWN.

**NOTE: J6 should not be used when J4 and J5 are in use.**

Pin	Type	Description	MXT	LCD	QT	EE
1	I/O	One-Wire Interface				•
2	P	GND				
3	I	LCD_DATA_0		•		
4	I	LCD_DATA_1		•		
5	I	LCD_DATA_2		•		
6	I	LCD_DATA_3		•		
7	P	GND				
8	I	LCD_DATA_4		•		
9	I	LCD_DATA_5		•		
10	I	LCD_DATA_6		•		
11	I	LCD_DATA_7		•		
12	P	GND				
13	I	LCD_DATA_8		•		
14	I	LCD_DATA_9		•		
15	I	LCD_DATA_10		•		
16	I	LCD_DATA_11		•		
17	P	GND				
18	I	LCD_DATA_12		•		
19	I	LCD_DATA_13		•		
20	I	LCD_DATA_14		•		
21	I	LCD_DATA_15		•		
22	P	GND				
23	I	LCD_DATA_16		•		
24	I	LCD_DATA_17		•		
25	I	LCD_DATA_18		•		

Pin	Type	Description	MXT	LCD	QT	EE
26	I	LCD_DATA_19		•		
27	P	GND				
28	I	LCD_DATA_20		•		
29	I	LCD_DATA_21		•		
30	I	LCD_DATA_22		•		
31	I	LCD_DATA_23		•		
32	P	GND				
33	I	PCLK		•		
34	I	VSYNC		•		
35	I	HSYNC		•		
36	I	DE		•		
37	-	N/C				
38	-	N/C				
39	-	N/C				
40	-	N/C				
41	I	DISP		•		
42	I	I <sup>2</sup> C SDA	•		•	
43	I/O	I <sup>2</sup> C SCL	•		•	
44	O	~MXT_CHG	•			
45	O	~QT_CHG			•	
46	I	LCD_PWM		•		
47	I	~RESET	•		•	
48	P	+3.3Vdc				
49	P	+3.3Vdc				
50	P	GND				

### 1.7 Display Flex Connector J8

Connector J8 connects to the LCD panel flex and carries signals between the host and the LCD Panel.

Pin	Type	Description
1	O	U/D
2	O	L/R
3	P	GND
4	O	PCLK
5	P	GND
6	O	R0
7	O	R1
8	O	R2
9	P	GND
10	O	R3
11	O	R4
12	O	R5
13	P	GND
14	O	G0
15	O	G1
16	O	G2
17	P	GND
18	O	G3
19	O	G4
20	O	G5

Pin	Type	Description
21	P	GND
22	O	B0
23	O	B1
24	O	B2
25	P	GND
26	O	B3
27	O	B4
28	O	B5
29	P	GND
30	O	HSYNC
31	O	VSYNC
32	O	DE
33	O	MODE
34	P	+3.3Vdc
35	P	+3.3Vdc
36	P	LED-
37	P	LED-
38	O	LCD_PWM
39	P	LED+
40	P	LED+

## 1.8 Touch Sensor Flex Connector J7

Connector J7 connects to the touch sensor flex and carries signals used by the maXTouch controller to detect user input on the touch sensor.

Pin	Type	Description
1	P	GND
2	I/O	X0
3	I/O	X1
4	I/O	X2
5	I/O	X3
6	I/O	X4
7	I/O	X5
8	I/O	X6
9	I/O	X7
10	I/O	X8
11	I/O	X9
12	I/O	X10
13	I/O	X11
14	I/O	X12
15	I/O	X13
16	I/O	X14
17	I/O	X15
18	I/O	X16
19	I/O	X17
20	I/O	X18
21	P	GND
22	I/O	Y0
23	I/O	Y1
24	I/O	Y2
25	I/O	Y3
26	I/O	Y4
27	I/O	Y5
28	I/O	Y6

Pin	Type	Description
29	I/O	Y7
30	I/O	Y8
31	I/O	Y9
32	I/O	Y10
33	I/O	Y11
34	I/O	Y12
35	I/O	Y13
36	I/O	Y14
37	I/O	Y15
38	I/O	Y16
39	I/O	Y17
40	I/O	Y18
41	I/O	Y19
42	I/O	Y20
43	I/O	Y21
44	I/O	Y22
45	I/O	Y23
46	I/O	Y24
47	I/O	Y25
48	I/O	Y26
49	I/O	Y27
50	I/O	Y28
51	I/O	Y29
52	I/O	Y30
53	I/O	Y31
54	P	GND
55	P	GND

## 2 Overview of the 7in PCAP Touch Module

### 2.1 Introduction

The 7in PCAP Touch Module is a touchscreen module offering best-in-class projected capacitance multi-touch functionality combined with a 7in LCD panel. The module is configured for development and evaluation with several Atmel ARM-based EK solutions as well as development and integration with a custom host system.

For convenience, this module features host interface connectors ([J4](#) and [J5](#)) positioned for direct installation on Atmel ARM-based EK boards.

As shown in Figure 2 below, the module provides host access to several sub-system components to maximize effective integration.

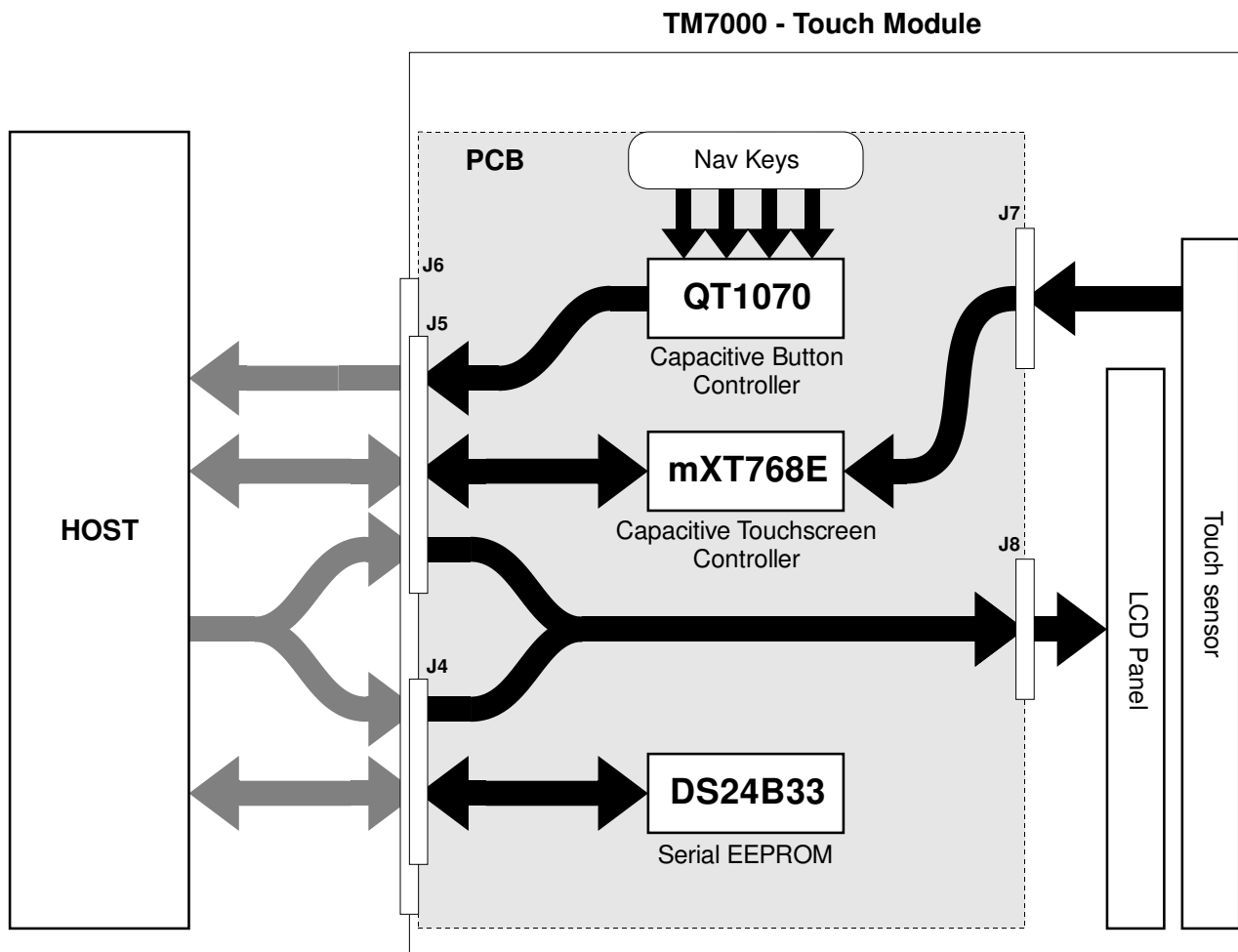

Figure 2 - Functional Block Diagram

## 2.2 Understanding Unfamiliar Concepts

Throughout this document, the functionality of the module sub-system will be outlined and summarized. However, the user is encouraged to refer to the resources and documents below in order to gain a more thorough understanding of each sub-system.

- For a basic overview of I<sup>2</sup>C communication, refer to [Section 5](#) of this document
- Atmel maXTouch mXT768E Datasheet ([www.atmel.com](http://www.atmel.com))
- Atmel QTouch QT1070 Datasheet ([www.atmel.com](http://www.atmel.com))
- Maxim DS24B33 Datasheet ([www.maximintegrated.com](http://www.maximintegrated.com))

In addition, when developing or evaluating with the Atmel ARM-based EK's, it is recommended that the user visit [www.at91.com](http://www.at91.com) which contains a broad range of resources for the EK's and the ARM devices they feature.

## 2.3 LCD Panel

The module provides the host with a direct connection from the host ([Connector J6](#) or [Connectors J4](#) and [J5](#)) to the LCD panel interface ([Connector J8](#)). Aside from generating supply voltages for the LED backlight and providing backlight control to the host, no display panel control is performed by the module.

### 2.3.1 Scan Direction Selection

The touch module provides a means for configuring the scan direction of the LCD by populating resistors indicated in Figure 3 below.

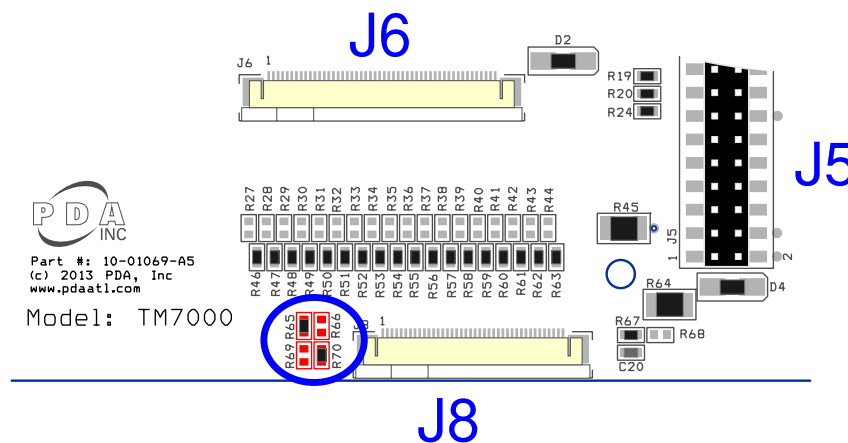

**Figure 3 – LCD Scan Direction Configuration Resistors**

The LCD panel Up/Down scanning direction is configured by populating R69 and R65 as shown in Table 2-1 below. The LCD panel Left/Right scanning direction is configured by populating R70 and R66 as shown in Table 2-2 below.

**Table 2-1 - LCD Up/Down Scanning Selection**

R69	R65	Direction
0 Ω	DNP	Up
DNP	0 Ω	<b>Down</b>

Note: Factory setting is scanning “Down”

Table 2-2 - LCD Left/Right Scanning Selection

R70	R66	Direction
0 Ω	DNP	Right
DNP	0 Ω	Left

Note: Factory setting is scanning "Right"

### 2.3.2 RGB Signal Routing

To support use with multiple host EK options, the touch module provides a means for selecting the routing of LCD\_DAT\_xx signals to the LCD RGB data signals by populating one of the two groups of resistors indicated in Figure 4 below.

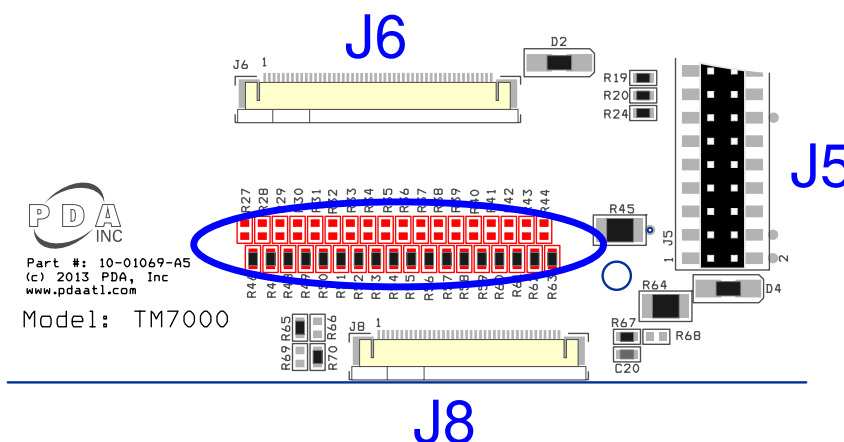

Figure 4 – RGB Signal Routing Configuration Resistors

Populating resistors R46-R63 selects the Atmel "Series-5 / A5D3x" routing scheme. Populating resistors R27-R44 selects the Atmel "Islero" routing scheme. The PCB ships with R46-R63 populated – selecting the "Series-5 / A5D3x" scheme by default.

Details of each scheme are shown in Table 2-3 below.



**Table 2-3 – RGB Signal Routing Selection**

Series 5/A5D3x (R46 – R63)	Islero (R27 - R44)	LCM
LCD_DAT_17	LCD_DAT_23	R5
LCD_DAT_16	LCD_DAT_22	R4
LCD_DAT_15	LCD_DAT_21	R3
LCD_DAT_14	LCD_DAT_20	R2
LCD_DAT_13	LCD_DAT_19	R1
LCD_DAT_12	LCD_DAT_18	R0
LCD_DAT_11	LCD_DAT_15	G5
LCD_DAT_10	LCD_DAT_14	G4
LCD_DAT_9	LCD_DAT_13	G3
LCD_DAT_8	LCD_DAT_12	G2
LCD_DAT_7	LCD_DAT_11	G1
LCD_DAT_6	LCD_DAT_10	G0
LCD_DAT_5	LCD_DAT_7	B5
LCD_DAT_4	LCD_DAT_6	B4
LCD_DAT_3	LCD_DAT_5	B3
LCD_DAT_2	LCD_DAT_4	B2
LCD_DAT_1	LCD_DAT_3	B1
LCD_DAT_0	LCD_DAT_2	B0

Note: Factory setting is “Series 5/A5D3x”

## 2.4 maXTouch Capacitive Touchscreen Controller

The module touch screen interface is based on the Atmel maXTouch mXT768E Touch Controller and operates using the touch sensor at [connector J7](#).

The touch controller scans the touch sensor and will signal the host with an active low interrupt signal (~MXT\_CHG on [J4](#) or [J6](#)) when new touch data is available. Data communication with the maXTouch controller is performed over a shared I<sup>2</sup>C interface (I<sup>2</sup>C SCL and I<sup>2</sup>C SDA on [J4](#) or [J6](#)). The I<sup>2</sup>C address of the touch controller can be configured by populating R12 or R13 (shown below in Figure 5) according to Table 2-4 below. The PCB ships with R12 populated – thus the I<sup>2</sup>C address is set to 0x4C by default.

**NOTE: The TM7000 does not have pull-up resistors on the I<sup>2</sup>C SCL and SDA lines. A pull-up resistor for the maXTouch ~CHG interrupt signal is located at R14.**

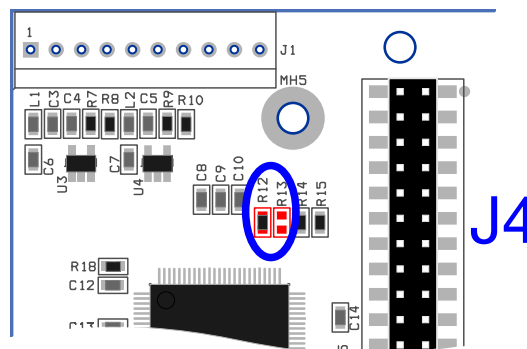

**Figure 5 - Touch Controller I<sup>2</sup>C Address Selection**

Table 2-4 - Touch Controller I<sup>2</sup>C Address Selection

R12	R13	I <sup>2</sup> C Address
0 Ω	DNP	0x4C
DNP	0 Ω	0x4D

Note: 0x4C is the default I<sup>2</sup>C address

### 2.4.1 maXTouch Controller Interface

Details of the maXTouch communication protocol are beyond the scope of this document. However information is provided in Section 3.2 below to facilitate evaluation and initial development.



**This module is pre-loaded with a configuration already optimized for this touch sensor and panel, so the developer need only focus on interfacing with the device. When developing the maXTouch controller interface during evaluation and host development, care should be taken to avoid changing the maXTouch configuration or committing changes to NV storage on the maXTouch controller.**

To get started with host interface development, the user is *strongly* encouraged to leverage existing code available from the resources outlined in Sections 3.2.

## 2.5 QTouch Capacitive Button Controller

The module's "nav key" interface is based on the Atmel QT1070 7-Channel Capacitive Sensor Driver.

The button controller scans the 4 capacitive nav keys (K1, K2, K3 and K4) and will signal the host with an active low interrupt signal (~QT\_CHG on [Connector J4](#) or [J6](#)) when a touch event has occurred. Data communication with the QT1070 controller is performed over a shared I<sup>2</sup>C interface (I<sup>2</sup>C SCL and I<sup>2</sup>C SDA on [J4](#) or [J6](#)). The I<sup>2</sup>C address of the button controller is 0x1B and cannot be changed.

**NOTE: The TM7000 does not have pull-up resistors on the I<sup>2</sup>C SCL and SDA lines. A pull-up resistor for the QTouch ~CHG interrupt signal is located at R16.**

### 2.5.1 QTouch Controller Interface

Details of the QTouch communication protocol are beyond the scope of this document. The user is encouraged to review the QT1070 Datasheet ([www.atmel.com](http://www.atmel.com)).

## 2.6 Serial EEPROM

The module includes a DS24B33 Serial EEPROM providing 512 bytes of non-volatile storage. Data communication with the EEPROM is performed over a One-Wire Interface. The EEPROM is not used by another subsystem on the touch module and can be freely used by the host system for any purpose. For example, Atmel ARM-based EK's running Linux or Android operating systems use the pre-programmed contents of the EEPROM to identify this module type.



**NOTE: The user should take care if choosing to overwrite the pre-programmed EEPROM contents. As noted above, certain builds of Linux or Android targeted for the Atmel ARM-based EKs use the EEPROM contents to identify the module and may no longer recognize the module. The user is advised to backup the EEPROM contents before overwriting.**

The serial EEPROM communicates via a one-wire interface (One-wire Interface on [J5](#) or [J6](#)). Refer to the DS24B33 Datasheet ([www.maximintegrated.com](http://www.maximintegrated.com)) for details.

## 3 Getting Started

This module was designed to install on a variety of Atmel ARM-based EK's including the SAM9X5-EK, SAM9N12-EK, SAMA5D3x-EK and the SAMA5D3 Xplained. This provides the fastest way to evaluate the performance of the touchscreen and display using a familiar, full-featured OS.

The following sections provide basic information related to using and evaluating the Touch Module. Visit Precision Design Associates website ( [www.pdaatl.com](http://www.pdaatl.com) ) or Atmel's AT91 Community website ( [www.at91.com](http://www.at91.com) ) for more information related to this touch module or guidance appropriate for your specific EK.

### 3.1 Hardware Connections

The module interfaces with the EK board via one of two methods depending on the EK:

- the two large dual-row headers, [J4](#) and [J5](#)
- the flex connector, [J6](#)

Refer to the specific EK documentation to determine which method is appropriate.

### 3.2 Software

Several options exist when developing for the touch module whether targeting a custom host or an Atmel EK.

#### 3.2.1.1 Atmel Software Framework

The Atmel Software Framework ([asf.atmel.com](http://asf.atmel.com)) contains examples of code for interfacing with devices in the maXTouch family of touch controllers. The capabilities of various maXTouch devices may differ, but the basic communication protocol is common and can be applied to this module.

#### 3.2.1.2 Linux Kernel / Android

The Linux Kernel ([www.kernel.org](http://www.kernel.org)) has included basic support for maXTouch touch devices since version 2.6.36. The mainline driver has undergone considerable evolution since then.

Atmel hosts the AT91 community website with resources dedicated to developing their EKs for Android ( [www.at91.com/android4sam/](http://www.at91.com/android4sam/) ) and Linux ( [www.at91.com/linux4sam/](http://www.at91.com/linux4sam/) )





In addition, Atmel maintains patches ([www.github.com/atmel-maxtouch/linux](http://www.github.com/atmel-maxtouch/linux)) which provide numerous out-of-cycle improvements to the mainline Linux Kernel driver.

## 3.3 Using the Touch Module

### 3.3.1 Navigation Keys

When using this module with one of the standard Atmel Android demo builds, the navigation keys function as shown in Table 3-1 below:

Table 3-1 - Navigation Key Function (Android)

Key	Navigation Function
K1	 Back
K2	 Menu
K3	 Home
K4	 Power / Sleep

### 3.3.2 Evaluating the Touch Module

For effective evaluation of the module – the touch sensor and the LCD panel in particular – the user is encouraged to try the following applications and tools depending on the host OS.

#### 3.3.2.1 Android

The following Android apps available from Google Play:

[TouchTest](#) by Moonblink

[Doty](#) by Gerry Steele

[Multitouch Visible Test](#) by Battery Powered Games

[Screen Test](#) by Amberfog

#### 3.3.2.2 Linux

The user can perform simple touch / drawing test using the `ts_test` utility that is part of **tslib**.

## 4 Specifications

For complete specifications, refer to the datasheets listed in section 2.2 for the various sub-system components outlined in sections 2.3 through 2.6.

### 4.1 Mechanical Specifications

Drawings and CAD models available upon request.

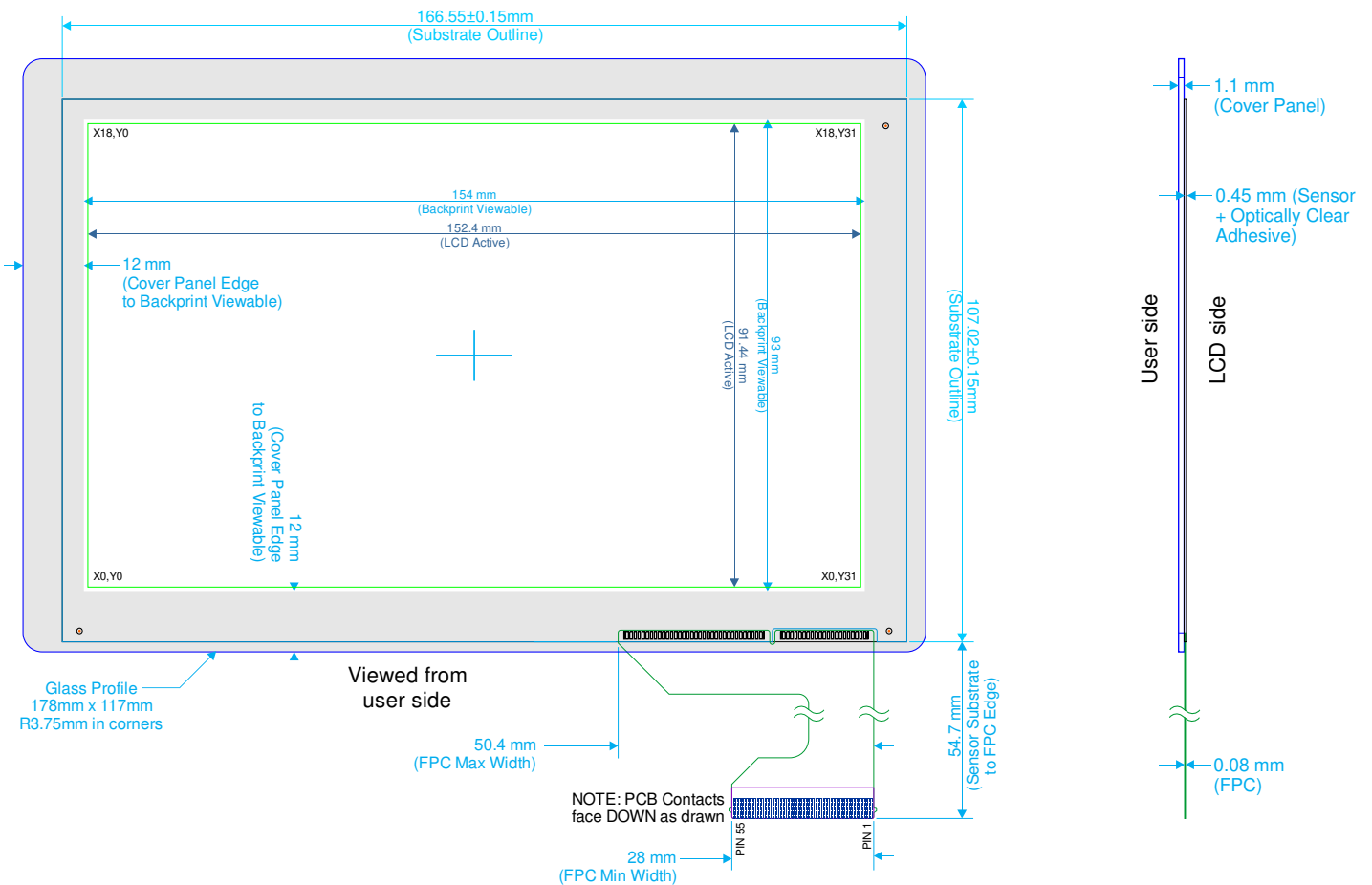

**Figure 6 - Sensor Only Dimensions**

Sensor Assy (P/N: 90-00020-A0) may be purchased individually.  
Minimum order quantities apply. Contact PDA for details.

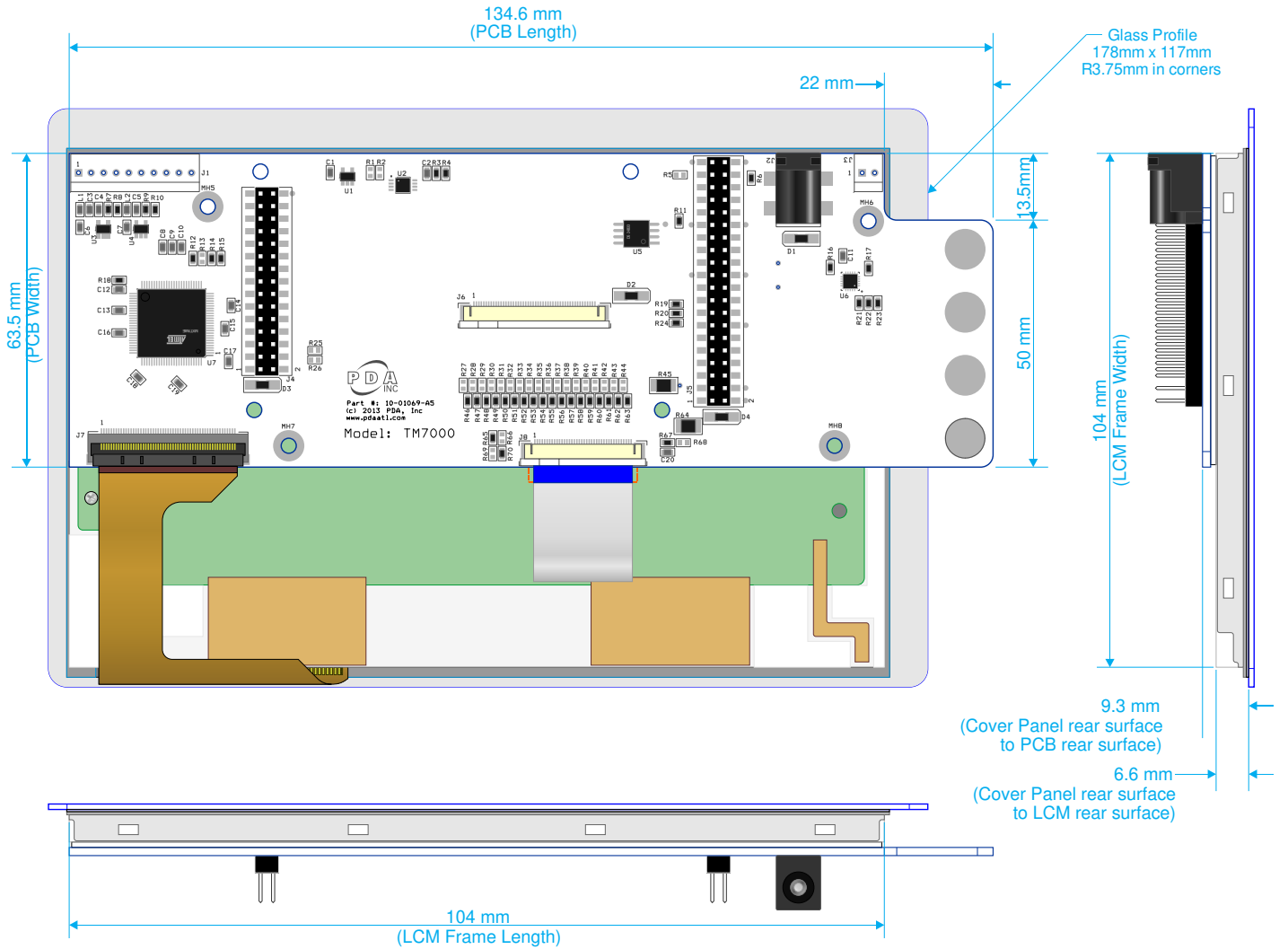



Figure 7 – Module Dimensions



## 4.2 Absolute Maximum Specifications

Parameter	Value
Operating temp	0°C to + 70°C
Storage temp	-40°C to + 85°C
Vdd	-0.5 to +6V
Max continuous pin current, any control or drive pin	±40 mA
Voltage forced onto any pin	-0.5V to (Vdd + 0.5) Volts
 <b>CAUTION:</b> Stresses beyond those listed under <i>Absolute Maximum Specifications</i> may cause permanent damage to the device. This is a stress rating only and functional operation of the device at these or other conditions beyond those indicated in the operational sections of this specification are not implied. Exposure to absolute maximum specification conditions for extended periods may affect device reliability.	

## 4.3 Recommended Operating Conditions

Parameter	Value
Vin	5.0V ±5 percent
Supply ripple + noise	±20 mV

## 4.4 DC Specifications

Vin = 5.0V, Vdd=3.3Vdc, Ta = recommended range, unless otherwise noted

Parameter	Description	Min	Typ	Max	Units	Notes
V <sub>IL</sub>	Low input logic level	- 0.5	–	0.3 Vdd	V	1.8V <Vdd <3.3V
V <sub>HL</sub>	High input logic level	0.7 Vdd	–	Vdd + 0.5	V	1.8V <Vdd <3.3V
V <sub>OL</sub>	Low output voltage	–	–	0.2Vdd	V	
V <sub>OH</sub>	High output voltage	0.8Vdd	–	–	V	
I <sub>IL</sub>	Input leakage current	–	–	1	µA	

#### 4.5 I2C-compatible Bus Specifications

Parameter	Operation
Touchscreen Controller Address	Selectable: 0x4C or 0x4D
Navigation Key Controller Address	0x1B
Maximum bus speed (SCL)	400 kHz
I2C Specification	Version 2.1

#### 4.6 Power Consumption

Vdd (V)	Mode	Idd (mA)
+3.3Vdc	mXT768E in Free Run, LCD backlight on maximum intensity	300 max
+5Vdc		650

#### 4.7 Part Number

Part Number	Description
90-00036-A0	TM7000: 7in PCAP Touch Module

## 5 I2C Basics (I2C-compatible Operation)

### 5.1 Interface Bus

The device communicates with the host over an I<sup>2</sup>C-compatible bus, in accordance with version 2.1 of the I<sup>2</sup>C specification. The following sections give an overview of the bus; more detailed information is available from [www.i2c-bus.org](http://www.i2c-bus.org). Devices are connected to the I<sup>2</sup>C-compatible bus as shown in Figure 8 both bus lines are connected to Vdd via pull-up resistors. The bus drivers of all I<sup>2</sup>C-compatible devices must be open-drain type. This implements a wired “AND” function that allows any and all devices to drive the bus, one at a time. A low level on the bus is generated when a device outputs a zero.

**Figure 8. I<sup>2</sup>C-compatible Interface Bus**

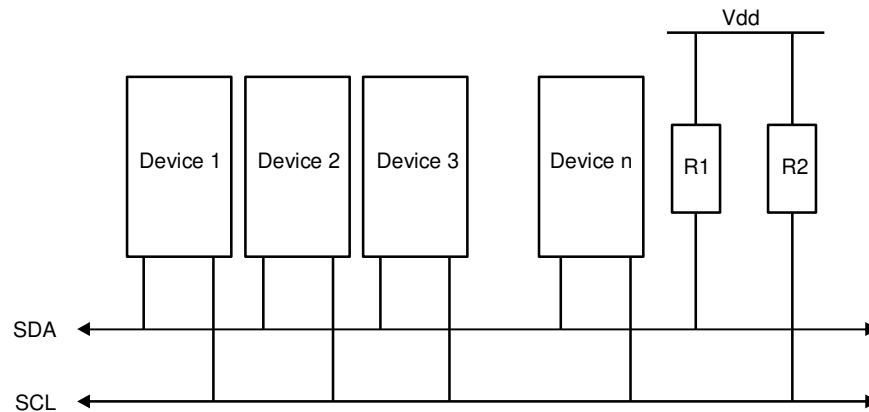

### 5.2 Transferring Data Bits

Each data bit transferred on the bus is accompanied by a pulse on the clock line. The level of the data line must be stable when the clock line is high; the only exception to this rule is for generating START and STOP conditions.

**Figure 9. Data Transfer**

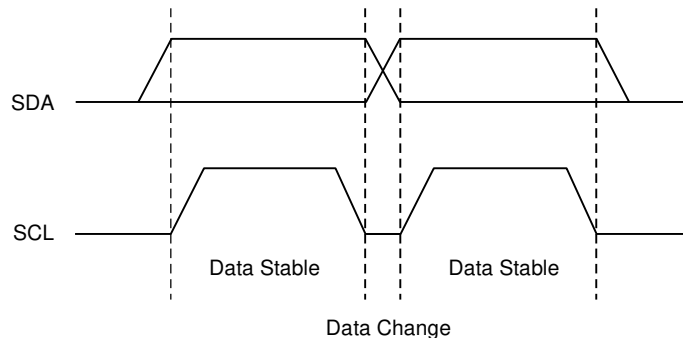

### 5.3 START and STOP Conditions

The host initiates and terminates a data transmission. The transmission is initiated when the host issues a START condition on the bus, and is terminated when the host issues a STOP condition. Between the START and STOP conditions, the bus is considered busy. As shown in Figure 10 START and STOP conditions are signaled by changing the level of the SDA line when the SCL line is high.

Figure 10. START and STOP Conditions

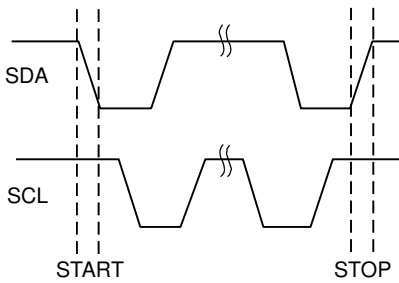

### 5.4 Address Byte Format

All address bytes are 9 bits long. They consist of 7 address bits, one READ/WRITE control bit and an acknowledge bit. If the READ/WRITE bit is set, a read operation is performed. Otherwise a write operation is performed. An address byte consisting of a slave address and a READ or a WRITE bit is called SLA+R or SLA+W, respectively. When the device recognizes that it is being addressed, it acknowledges by pulling SDA low in the ninth SCL (ACK) cycle.

The most significant bit of the address byte is transmitted first.

Figure 11. Address Byte Format

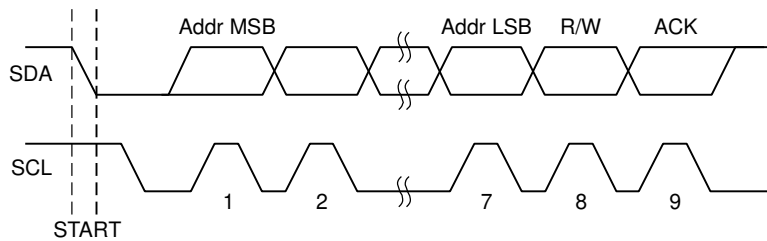

### 5.5 Data Byte Format

All data bytes are 9 bits long, consisting of 8 data bits and an acknowledge bit. During a data transfer, the host generates the clock and the START and STOP conditions. The slave device is responsible for acknowledging the reception. An acknowledge (ACK) is signaled by the slave device pulling the SDA line low during the ninth SCL cycle. If the slave device leaves the SDA line high, a NACK is signaled.

Figure 12. Data Byte Format

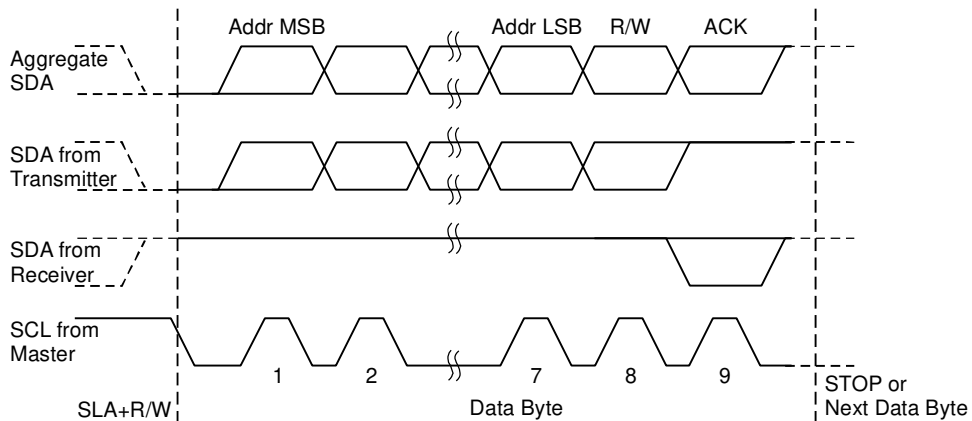

## 5.6 Combining Address and Data Bytes into a Transmission

A transmission consists of a START condition, an SLA+R or SLA+W, one or more data bytes and a STOP condition. The wired “ANDing” of the SCL line is used to implement handshaking between the host and the device. The device extends the SCL low period by pulling the SCL line low whenever it needs extra time for processing between the data transmissions.

Figure 13 shows a typical data transmission. Note that several data bytes can be transmitted between the SLA+R or SLA+W and the STOP.

**Figure 13. Byte Transmission**

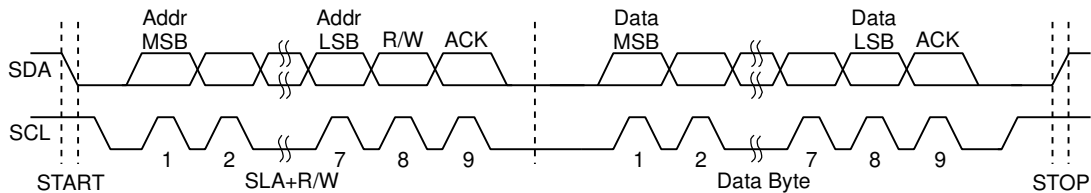

## 6 Revision History

Revision No.	History
Rev1403-1-1	Initial Draft (unreleased)
Rev1403-1-2 Rev1403-1-3 Rev1403-2-4	Preliminary Release (limited release)
Rev1404-3-5	Initial Release