



Chipsmall Limited consists of a professional team with an average of over 10 year of expertise in the distribution of electronic components. Based in Hongkong, we have already established firm and mutual-benefit business relationships with customers from,Europe,America and south Asia,supplying obsolete and hard-to-find components to meet their specific needs.

With the principle of “Quality Parts,Customers Priority,Honest Operation,and Considerate Service”,our business mainly focus on the distribution of electronic components. Line cards we deal with include Microchip,ALPS,ROHM,Xilinx,Pulse,ON,Everlight and Freescale. Main products comprise IC,Modules,Potentiometer,IC Socket,Relay,Connector.Our parts cover such applications as commercial,industrial, and automotives areas.

We are looking forward to setting up business relationship with you and hope to provide you with the best service and solution. Let us make a better world for our industry!



Contact us

Tel: +86-755-8981 8866 Fax: +86-755-8427 6832

Email & Skype: info@chipsmall.com Web: www.chipsmall.com

Address: A1208, Overseas Decoration Building, #122 Zhenhua RD., Futian, Shenzhen, China





Designers' Choice

AUDIO JACKS & "F" CONNECTORS

SURFACE MOUNT STEREO JACKS

- Mates with 2.5mm and 3.5mm plugs
- Designed for reliable interface with audio equipment including computer speakers, headphones, sound cards, cell phones, etc.
- Models available for mono and stereo applications
- Low profile, surface mount design

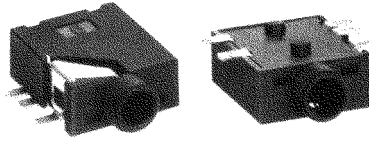

SPECIFICATIONS

Housing: Polyamide, Rated UL 94V-0
Ground Terminal: .012 Brass, Gold Flash ①
Spring Contacts: .008 Phosphor Bronze, Gold Flash ② ⑤
Shunt Terminals: .012 Brass, Gold flash ③ ④

FOR 2.5mm PLUGS

Supplied on Tape and Reel

FOR 3.5mm PLUGS

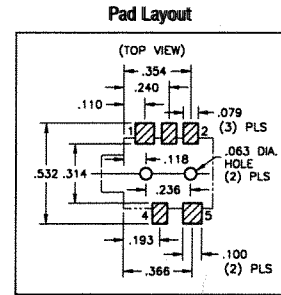
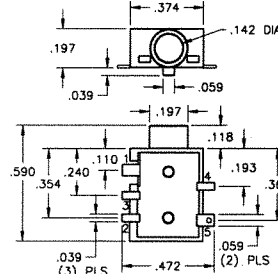
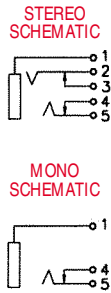
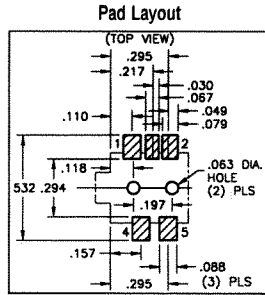
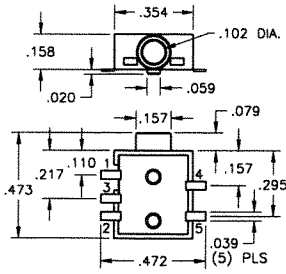

CAT. NO. 980TR (Stereo) Tape Spec's: 24mm wide; 16mm pitch
 CAT. NO. 982TR (Mono) Reel Spec's: 15 inch reel (1,000 pieces per reel)

CAT. NO. 981TR (Stereo) Tape Spec's: 24mm wide; 16mm pitch
 CAT. NO. 983TR (Mono) Reel Spec's: 15 inch reel (800 pieces per reel)

COLOR KEYED — PC PHONO JACKS

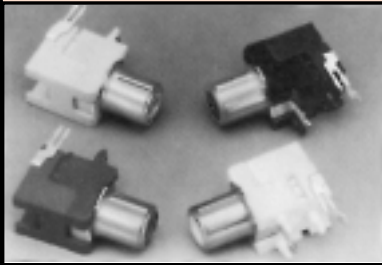

- Mates with .125 diameter pins
- Features a normally closed circuit
- Various colors for circuit identification
- Snap-fit mounting for positive retention during wave soldering

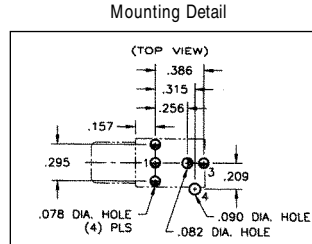
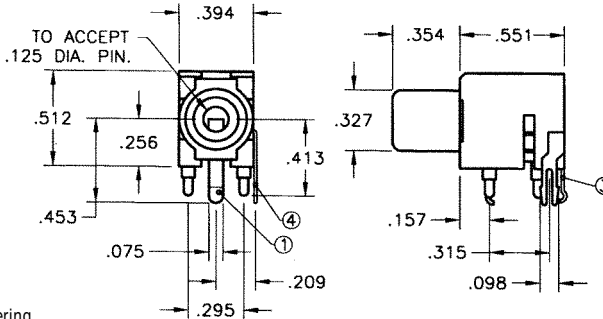

| CAT. NO. | COLOR |
|----------|--------|
| 970 | WHITE |
| 971 | RED |
| 972 | BLACK |
| 973 | YELLOW |

SPECIFICATIONS

Housing: PBT
Ground Terminal: .020 Brass, Nickel Plate ①
Spring Contact: .012 Phosphor Bronze, Silver Plate ③
Shunt Terminal: .016 Brass, Silver Plate ④

"F" FEMALE CONNECTORS

SNAP-FIT PC MOUNT

- Low profile
- Snap-fit mounting for positive retention during wave soldering
- Rugged, stable construction facilitates reliable mating
- High reliability, manufactured using Nickel Plated Brass bodies and Tin Plated Phosphor Bronze contacts
- Supplied with washer and nut

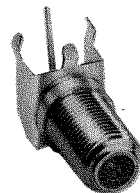
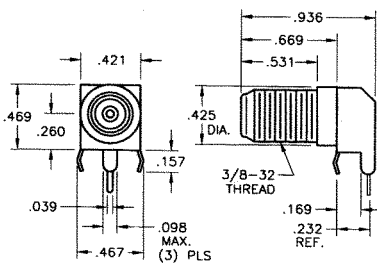

Mounting Detail

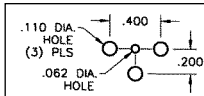

CAT. NO. 911

PANEL MOUNT

- Anti-rotation design
- Rugged construction facilitates reliable mating
- High reliability, manufactured using Nickel Plated Brass bodies and Tin Plated Phosphor Bronze contacts
- Supplied with washer and nut

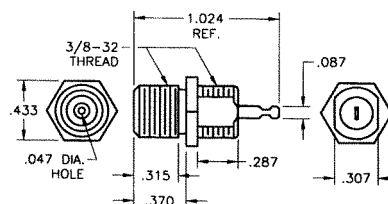

Mounting Detail

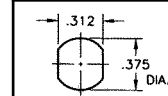

CAT. NO. 912