



Chipsmall Limited consists of a professional team with an average of over 10 year of expertise in the distribution of electronic components. Based in Hongkong, we have already established firm and mutual-benefit business relationships with customers from,Europe,America and south Asia,supplying obsolete and hard-to-find components to meet their specific needs.

With the principle of “Quality Parts,Customers Priority,Honest Operation,and Considerate Service”,our business mainly focus on the distribution of electronic components. Line cards we deal with include Microchip,ALPS,ROHM,Xilinx,Pulse,ON,Everlight and Freescale. Main products comprise IC,Modules,Potentiometer,IC Socket,Relay,Connector.Our parts cover such applications as commercial,industrial, and automotives areas.

We are looking forward to setting up business relationship with you and hope to provide you with the best service and solution. Let us make a better world for our industry!



## Contact us

Tel: +86-755-8981 8866 Fax: +86-755-8427 6832

Email & Skype: info@chipsmall.com Web: www.chipsmall.com

Address: A1208, Overseas Decoration Building, #122 Zhenhua RD., Futian, Shenzhen, China



DATE	REV	EON	APP'D. BY
1/30/06	A1	7462	JM
6-25-09	A2	8769	JM
2-14-11	A3	9128	TRM
5-23-12	A4	9477	SMN

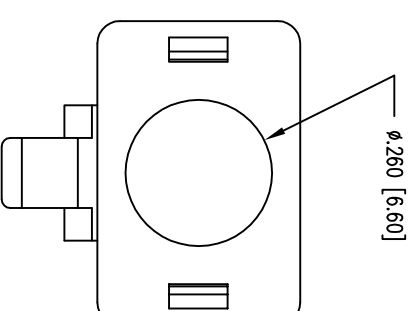
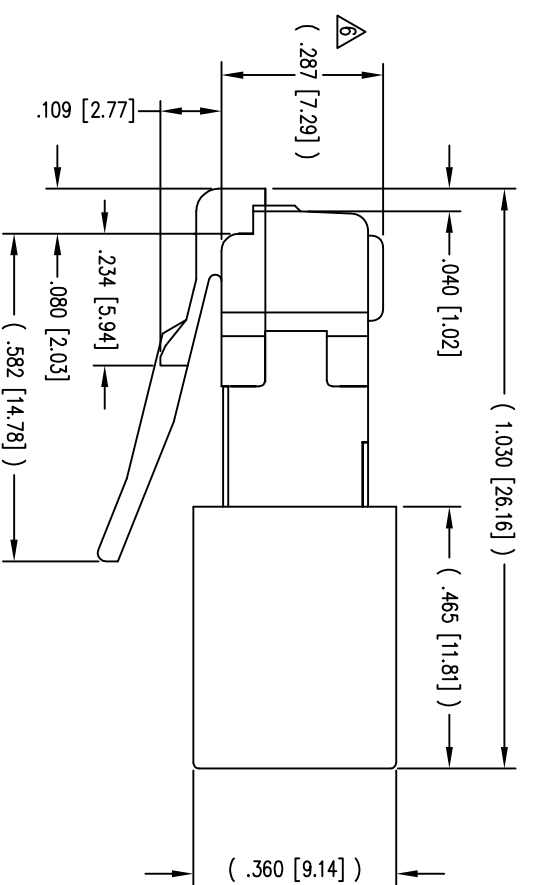
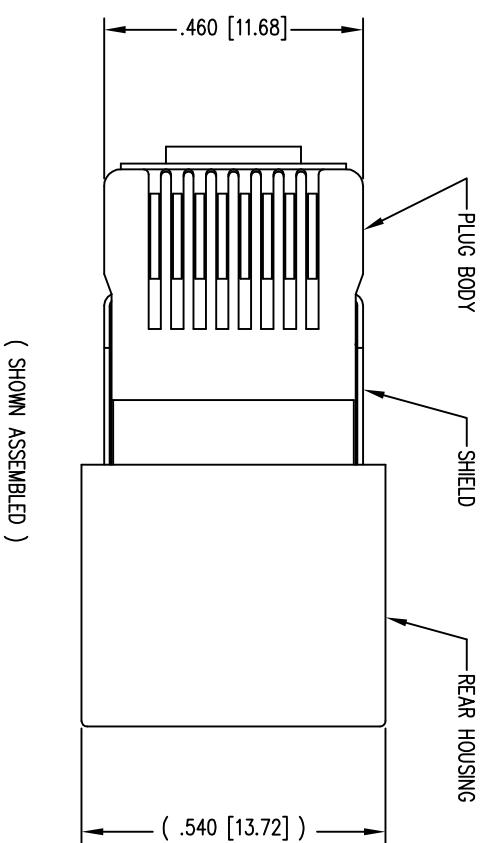

B

B

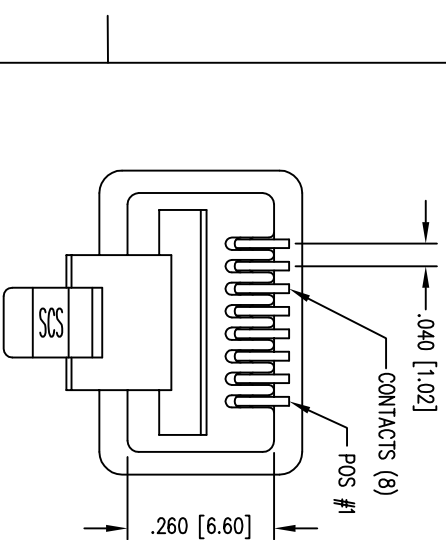

A

A

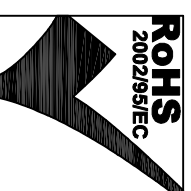
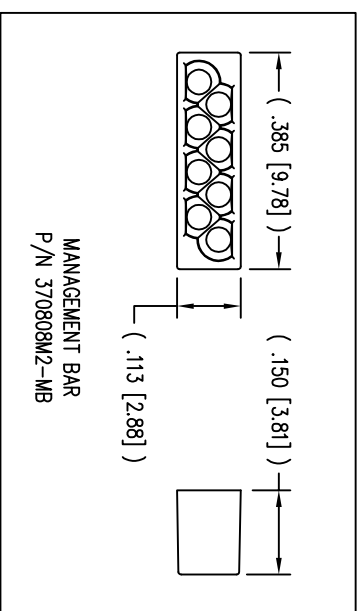
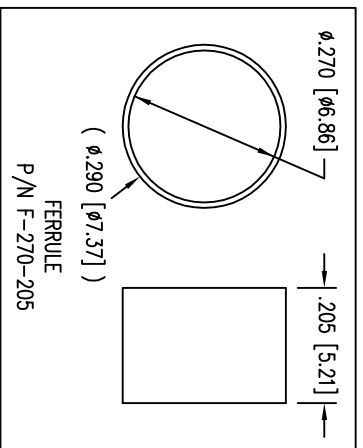

BULK	50 MICRO-INCHES [1.27um]	943-SP-370808SM2-A10
PACKAGE	CONTACT PLATING IN MATING AREA	PART NUMBER

- NOTES:
- 1- PLUG KIT CONSISTS OF :  
PRE-INSERTED PLUG HOUSING & SHIELD  
MANAGEMENT BAR  
FERRULE
  - 2- MATERIALS :  
FRONT HOUSING PLASTIC : CLEAR POLYCARBONATE, UL 94-V0  
MANAGEMENT BAR : CLEAR POLYCARBONATE, UL 94-V0  
SHIELD : TIN PLATED BRASS  
CONTACTS : PHOSPHOR BRONZE, SELECTIVE GOLD PLATING  
FERRULE : NICKEL OR TIN PLATED BRASS
  - 3- CONTACTS TERMINATE STRANDED & SOLID CONDUCTORS UP TO .042 [1.07] OUTSIDE DIAMETER OF INSULATION.
  - 4- FOR PRODUCT SPECIFICATION SEE PRO26-01.
  - 5- DIMENSIONS AND TOLERANCES COMPLY WITH TIA-1096 STANDARD.
  - 6- TERMINATED PLUG HEIGHT: .237 [6.02] ±.005 [0.13]
  - 7- DESIGNED FOR CATEGORY 5/5e APPLICATIONS.

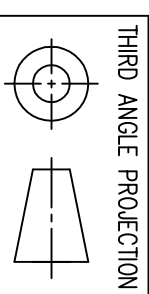

THIRD ANGLE PROJECTION  
DO NOT SCALE DRAWING  
DRAWING IS SUBJECT TO CHANGE WITHOUT NOTICE  
DIMENSIONS: INCHES [METRIC]  
UNLESS OTHERWISE SPECIFIED TOLERANCES ARE ±.005 [0.13]  
ANGLES ARE ± 1°

TITLE:  
SHIELDED CAT 5 PLUG, 8 X 8 SHIELDED PLUG

11118 Susquehanna Trail South  
Glen Rock, PA 17327-9199  
(717) 235-7512 Fax: (717) 235-7954  
<http://www.stewartconnector.com>

THIS DRAWING AND THE SUBJECT MATTER SHOWN THEREON ARE CONFIDENTIAL AND THE PROPRIETARY PROPERTY OF BEL STEWART CONNECTOR AND SHALL NOT BE REPRODUCED, COPIED, OR USED IN ANY MANNER WITHOUT PRIOR WRITTEN CONSENT OF BEL STEWART CONNECTOR. THIS PRODUCT MAY BE PROTECTED BY ONE OR MORE OF THE FOLLOWING US PATENTS: 5628847 6402559 6409533 6524728 7753717 8033863 OTHER PATENTS MAY BE PENDING.		DRN BY: R.S.	DATE: 11-8-96
SHEET NO. 1 OF 1	APP'D BY: R.J.	DATE: 11-8-96	REV: A4
DWG NO. CT370012		REV. A4	