



Chipsmall Limited consists of a professional team with an average of over 10 year of expertise in the distribution of electronic components. Based in Hongkong, we have already established firm and mutual-benefit business relationships with customers from,Europe,America and south Asia,supplying obsolete and hard-to-find components to meet their specific needs.

With the principle of “Quality Parts,Customers Priority,Honest Operation,and Considerate Service”,our business mainly focus on the distribution of electronic components. Line cards we deal with include Microchip,ALPS,ROHM,Xilinx,Pulse,ON,Everlight and Freescale. Main products comprise IC,Modules,Potentiometer,IC Socket,Relay,Connector.Our parts cover such applications as commercial,industrial, and automotives areas.

We are looking forward to setting up business relationship with you and hope to provide you with the best service and solution. Let us make a better world for our industry!



Contact us

Tel: +86-755-8981 8866 Fax: +86-755-8427 6832

Email & Skype: info@chipsmall.com Web: www.chipsmall.com

Address: A1208, Overseas Decoration Building, #122 Zhenhua RD., Futian, Shenzhen, China



DATE	DESCRIPTION	REV.
5.23.16	CHANGE AS PER ECN 16-060 UPDATE HOUSING	A

FRONT SHELL

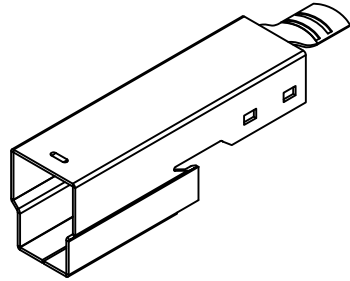

INSERTED BODY

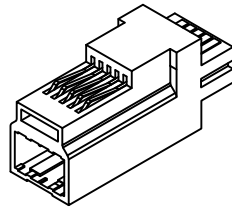

REAR SHELL

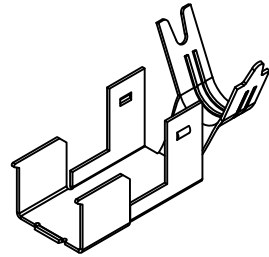

ASSEMBLED PLUG

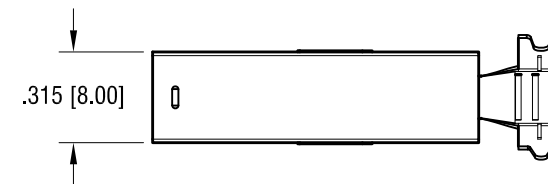
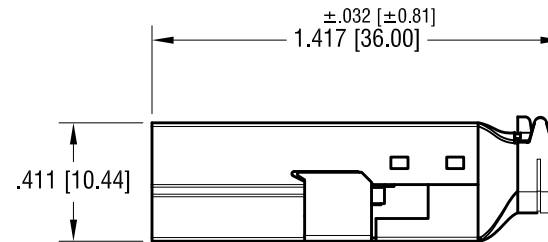
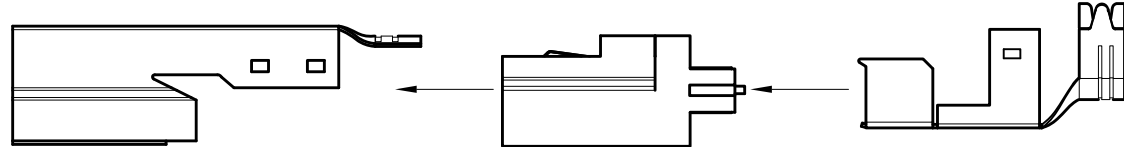
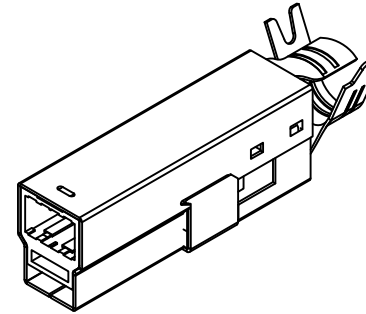

PLUG SPECIFICATIONS:

- SHELL: MAT'L- STEEL
- FINISH- NICKEL PLATE
- INSULATION: MAT'L- THERMOPLASTIC, UL 94V-0
- CONTACT: MAT'L- PHOSPHOR BRONZE
- FINISH- GOLD FLASH OVER NICKEL

ELECTRICAL CHARACTERISTICS:

- RATED VOLTAGE: 30V (RMS)
- CONTACT CURRENT RATING: 1 Amp DC MAX.
- CONTACT RESISTANCE: 15m Ω min.
- DIELECTRIC WITHSTANDING VOLTAGE: 750V AC FOR 1 MINUTE

MECHANICAL CHARACTERISTICS:

- OPERATING TEMPERATURE: -13°F (-25°C) TO 176°F (+80°C)
- DURABILITY: 1500 CYCLES MIN.

THIS DOCUMENT IS THE PROPERTY OF KEYSTONE ELECTRONICS CORP. AND SHALL NOT BE REPRODUCED, DISTRIBUTED OR USED AS A BASIS FOR MANUFACTURE WITHOUT PRIOR WRITTEN PERMISSION FROM KEYSTONE ELECTRONICS CORP.

KEYSTONE ELECTRONICS CORP.			
www.keyelco.com • ASTORIA, N.Y. 11105-2017 • Tel (718) 956-8900			
PART NAME		USB 3.0 TYPE B PLUG KIT	
MATERIAL		AS NOTED	
FINISH	AS NOTED	DRN BY NT	DATE 4.07.10
		APPD LN	SCALE 2X
TOLERANCES	INCH [MM]	CODE	DWG NO.
DECIMAL	± .010 [± 0.25]	C	952
ANGULAR	± 1°		
UNLESS OTHERWISE SPECIFIED			