



Chipsmall Limited consists of a professional team with an average of over 10 year of expertise in the distribution of electronic components. Based in Hongkong, we have already established firm and mutual-benefit business relationships with customers from,Europe,America and south Asia,supplying obsolete and hard-to-find components to meet their specific needs.

With the principle of “Quality Parts,Customers Priority,Honest Operation,and Considerate Service”,our business mainly focus on the distribution of electronic components. Line cards we deal with include Microchip,ALPS,ROHM,Xilinx,Pulse,ON,Everlight and Freescale. Main products comprise IC,Modules,Potentiometer,IC Socket,Relay,Connector.Our parts cover such applications as commercial,industrial, and automotives areas.

We are looking forward to setting up business relationship with you and hope to provide you with the best service and solution. Let us make a better world for our industry!



Contact us

Tel: +86-755-8981 8866 Fax: +86-755-8427 6832

Email & Skype: info@chipsmall.com Web: www.chipsmall.com

Address: A1208, Overseas Decoration Building, #122 Zhenhua RD., Futian, Shenzhen, China



5 0 Y E A R S O F E X C E L L E N C E

PANAVISE[®]
Innovative Holding Solutions[™]

PANAVISE[®]

The Industry Leader In:

> Work Holding Tools > CCTV Camera Mounts > Audio / Video Mounts > Mobile Electronics Mounts





Vision to Vise

PanaVise Products, Inc. was founded in 1956 by tool and die maker Otto Colbert.



PanaVise Products, Inc. designs, engineers and manufactures its "innovative holding solutions" in Reno, Nevada. Our 58,000 square foot facility contains our corporate offices, as well as manufacturing, warehousing and shipping facilities.

New product design is the responsibility of our engineering department. Special customer generated (OEM) projects are expertly guided through the engineering process, then carefully manufactured to meet your exact specifications. A wide range of equipment, including computerized lathes, sheet metal stamping machinery, bending, deburring, painting, and powder coating stations, means we can control the manufacturing process from beginning to end.

If you have a specific project in mind, don't hesitate to consult our engineering department at **1.800.759.7535**.

In 1956, Mr. Colbert needed an easy way to inspect and work on his dies. To make his work more productive, he invented and patented the famous "**split-ball**." The split-ball is a clever adaptation that allows a vise head to move easily through three planes (Tilt, Turn & Rotate) and to lock securely into position with a single control knob. To this day, his invention still forms the core of our product line.

Following in Mr. Colbert's footsteps, PanaVise continues to design and manufacture products that solve practical problems. Over the years, a natural outgrowth of our work holding expertise has been to develop other items which hold things securely and offer a wide range of motion. Our Mobile Electronics, CCTV Camera Mounts, and Audio/Video Mounts are perfect examples of how we've applied Mr. Colbert's philosophy to solve practical, real-world problems. Our dedication to finding innovative holding solutions has earned us the nickname "**the hold it anywhere you want it company.**"

PanaVise Products, Inc. is located in beautiful northern Nevada and operates in a 58,000 square foot facility (see photo, right). Our on-site engineering and manufacturing facilities give us complete control over product design, development, and production. We still believe in manufacturing quality products, and are dedicated to making the world's most "**Innovative Holding Solutions.**"

If you have questions about any of the products contained within this catalog, please call a PanaVise Representative at **1.800.759.7535**. Additional information can be found at our website, **www.panavise.com**.

Table of Contents

> Innovative Holding Solutions™

Limited Lifetime Warranty

All PanaVise products are warranted against defective materials and/or workmanship to all original consumer owners from the date of original consumer purchase for the lifetime of ownership by the original consumer owner. In the event of defective materials and/or workmanship, PanaVise Products, Inc. will, without charge, repair or replace, at its option, the defective product within 60-days from the receipt of the defective product at the following address:

PanaVise Products, Inc.
ATTN: Warranty Department
7540 Colbert Drive
Reno, NV 89511-1225

In order to make a claim under this Warranty and to obtain performance of any obligation under warranty, the consumer must call PanaVise's Warranty Department at 1.800.759.7535. Questions will be answered and/or instructions given on how to return the defective product to PanaVise.

The Warranty does not apply to damage not resulting from defective materials and/or workmanship while in the possession of the original consumer or to unreasonable use by the original consumer, which includes but is not limited to improper installation, or failure to provide reasonable and necessary maintenance. (Due to normal wear and tear, vise jaws, suction cups and vacuum pads are not covered by this Warranty.) PanaVise Products, Inc. is not liable for any incidental or consequential damages. Some states do not allow the exclusion or limitation of incidental or consequential damages, so the above limitation or exclusion may not apply to you. This Warranty gives you specific legal rights, and you may also have other rights which vary from state to state.

Patents, Trademarks & Copyright

PanaVise's products are protected under one or more of the following U.S. Patents: 2,898,068; 3,661,376; 5,118,058; 5,187,744; 5,465,932; D390,849. Patents pending on additional products in the U.S. and in other countries.

PanaVise, PanaPress, PV, PV Jr., Posi-Stop, Slimline, Slimline 2000, Uniflex, Stay-Put, PortaGrip, PortaGrip 2000, InDash, WindowGrip Deluxe, Multi Media Mount, ClipCaddy, and ViseBuddy are registered trademarks or trademarks of PanaVise Products, Inc. in the U.S. and in other countries.

All materials contained in this catalog (such as text, graphics, logos, pictures, and images) are protected by United States copyright law and may not be reproduced, distributed, transmitted, displayed, published, or broadcast without the prior written permission of PanaVise Products, Inc. You may not remove or alter any copyright, patent, trademark, or other notice from this material.

©2006 PanaVise Products, Inc.

Product specifications are subject to change without notice.

Work Holding Tools : Vise Combinations, Heads, Bases & Arbor Presses

Work Holding Tools Introduction	4-5
Precision Vise Combinations	6-8
Component Interchangeability Chart	9
Vise Heads	10-12
Vise Bases	13
Vise Base Mounts	14-15
Circuit Board Holders	16-17
Circuit Board Accessories	17
PanaPress Arbor Press	18
PanaPress Retrofit Kits and Accessories	18-19
IDC Assembly Press Accessories	20
Heavy Duty Vise	21
Vise Accessories	22-23

CCTV Camera Mounts : For Professional Installers

CCTV Camera Mounts Introduction	24-25
Small Camera Mounts	26-27
J-Box Mounts	28-29
Standard Camera Mounts	30-31
Specialty Camera Mounts	32-33
Custom Component System	34-35

Audio/Video Mounts : For Speakers & Flat Panel Displays

Audio/Video Mounts Introduction	36-37
Small Speaker Mounts (up to 20 lbs.)	38-39
Large Speaker Mounts (up to 40 lbs.)	40-41
Flat Screen Mounts	42-43

Mobile Electronics Mounts : For Satellite Radios, GPS, Etc

Mobile Electronics Mounts Introduction	44-45
Window Mounts	46-47
Custom Dash Mounts and Accessories	48-49
Mounting Accessories	50-51
Mobile Electronics Holders	51
Pedestal Mounts	52-53
Radio and Communications Mounts	54
Custom Communications Mounting System	55
Mobile Data Terminal Mounts	56-58
Flex Mounts	59

Product Index : Quick Reference Guide

Index by Model Number	60
Index by Product Name	61



PARAVISE®

Work Holding Tools

> Innovative Holding Solutions™

Tilt, Turn & Rotate

PanaVise's patented "split-ball" allows the vise head to move smoothly through 3-planes: Tilts 90°, Turns & Rotates 360° to position the vise head exactly where you want it.



Accessories

Unique vise accessories (pages 22-23) help keep you organized! Here the Wire Manager, Model 358, keeps the leads under control, and when combined with the Solder Station, Model 371, makes a neat, efficient work station.

Interchangeability

All 300 series Vise Heads (pages 10-12) fit all 300 series Vise Bases (page 13). Work on a circuit board in the morning and a model train in the afternoon! If you already own a PanaVise, you can easily expand its capabilities by adding another Vise Head.



Base Mounts

Because you work in different environments, PanaVise Base Mounts help you work more efficiently. Base Mounts (pages 14-15) include mounting screws and fit the PV Jr. Model 201, 300 and 305 Bases.

One Knob; 3-planes

A single knob controls the Vise Head. Loosen the knob and the Vise Head moves smoothly into position; tighten it and the Vise Head locks into place.

Precision Vise Combinations

PanaVise vises and work holding tools have hundreds of uses limited only by your imagination! Each vise allows the head to "Tilt, Turn & Rotate" and position your work anywhere you want it. Our precision vises make any project more productive — PanaVise: "Better than a third hand!"

PV Jr. Model 201

The AMAZING Mini-Vise: perfect for arts and crafts, model making, electronics and other small projects!



Model 201 Features:

- > The easy-to-use single knob controls head movement through 3-planes: 210° Tilt, 360° Turn & 360° Rotation
- > Fine/coarse adjusting knob controls jaw pressure for delicate work
- > Grooved jaws are excellent for holding small objects and are made of reinforced thermal composite plastic [continuous heat tolerance to 350°F (177°C), intermittent heat up to 450°F (204°C)]
- > Jaws are 2" (50.8mm) tall, 1" (25.4mm) wide, and open to 2.875" (73mm)
Neoprene jaw pads are available (page 22) for holding extremely delicate items
- > Base features 4.3125" (109.5mm) bolt circle countersunk for three 1/4" (6.3mm) flat-head screws (not included); compatible with all PanaVise Base Mounts (pages 14-15)
- > **Height:** 6.75" (173mm), **Weight:** 1.2 lbs. (0.6kg)

Vacuum Base PV Jr. Model 209

The most PORTABLE precision vise you'll ever own! Ideal for light-duty field repairs, electronics, hobbies and more!



Model 209 Features:

- > The easy-to-use single knob controls head movement through 3-planes: 210° Tilt, 360° Turn & 360° Rotation
- > Fine/coarse adjusting knob controls jaw pressure for delicate work
- > Grooved jaws are excellent for holding small objects and are made of reinforced thermal composite plastic [continuous heat tolerance to 350°F (177°C), intermittent heat up to 450°F (204°C)]
- > Jaws are 2" (50.8mm) tall, 1" (25.4mm) wide, and open to 2.875" (73mm)
- > Arm movement is 140°; positive indents control movement to prevent "flopping"; the control knob locks the arm firmly into place
- > Lever locks vacuum pad into place on any smooth, flat, non-porous surface; lift tab to release vise from surface
- > **Base Diameter:** 3.4" (86.4mm), **Height:** 7.5" (173mm), **Weight:** 0.8 lbs. (0.4kg)

All PanaVise 300 series Vises have interchangeable components (see chart page 9). You can easily add another Head (pages 10-12) or Base Mount (pages 14-15). All PanaVise work holding tools will make your work space more efficient and productive — and they'll provide a lifetime of service.

Standard PanaVise Model 301

The ORIGINAL work holding tool for hobbies, electronics, small home repairs and work bench environments!



Model 301 Features:

- > The easy-to-use single knob controls head movement through 3-planes: 90° Tilt, 360° Turn & 360° Rotation
- > Jaws are 2.5" (63.5mm) wide, 0.5" (12.6mm) tall and open to 2.25" (57.1mm)
- > Nylon jaws offer excellent electrical insulation and gentle holding power [continuous heat tolerance up to 200°F (93°C), intermittent heat to 300°F (149°C)]. Interchangeable jaws available (page 22)
- > Base accepts all 300 series Heads and any 5/8" (15.9mm) diameter shaft
- > Base features 4.3125" (109.5 mm) bolt circle countersunk for three 1/4" (6.3mm) flat-head screws (not included)
- > **Height:** 6.25" (171.4mm), **Weight:** 2.7 lbs. (1.2kg)

Vacuum Base PanaVise Model 381

The world's most PORTABLE work holding tool for hobbies, electronics and small home repairs!



Model 381 Features:

- > Our Vacuum Base PanaVise is widely used for portable applications. Simply flip the lever to activate the rubber base and attach the unit to any smooth, flat, non-porous surface
- > Single knob controls head movement through 3-planes: 90° Tilt, 360° Turn & 360° Rotation
- > Jaws are 2.5" (63.5mm) wide, 0.5" (12.6mm) tall and open to 2.25" (57.1mm)
- > Nylon jaws offer excellent electrical insulation and gentle holding power [continuous heat tolerance up to 200°F (93°C), intermittent heat to 300°F (149°C)]. Interchangeable jaws available (page 22)
- > Base accepts all 300 series Heads and any 5/8" (15.9mm) diameter shaft
- > Pad footprint measures 5.125" x 4.25" (130.2mm x 108mm)
- > **Height:** 6.125" (155.6mm), **Weight:** 2.8 lbs. (1.3kg)

Precision Vise Combinations

We've selected some of our more specialized Heads, Bases and even a Base Mount to create two unique Vise combinations. These specialty tools are ready for a lifetime of service, plus they're compatible with all 300 series interchangeable components (chart page 9), and include the patented "split-ball" which allows a Head to be positioned through 3-planes: 90° Tilt, 360° Turn & 360° Rotation.

Multi-Purpose Work Center Model 350

The MULTI-PURPOSE work holding tool for larger, heavier objects. It's perfect for home repair or hobby needs!



Model 350 Features:

- > Self-centering, extra-wide opening jaws open a full 9" (228.6mm) and hold heavier objects by centering weight over base
- > Parts Tray Base Mount adds stability [8.5" (215.9mm) diameter] and has six individual trays to neatly hold small parts and tools. Includes six non-marring, anti-skid pads
- > Ribbed, neoprene jaw pads are 1.875" (47.6mm) high x 1.5" (38.1mm) wide and provide a sure grip; reverse the pads and the wide "V" holds cylindrical objects
- > Single knob controls head movement through 3-planes: 90° Tilt, 360° Turn & 360° Rotation
- > "Double-action" jaws open/close quickly. Can be reversed to provide 'zero' closure
- > Base accepts all 300 series Heads and any 5/8" (15.9mm) diameter shaft
- > **Height:** 7.875" (200mm), **Weight:** 5.0 lbs. (2.3kg)

Wide Opening Head PanaVise Model 396

The work holding tool with EXPANDED capabilities, perfect for holding larger objects!



Model 396 Features:

- > Wide opening jaws open a generous 6" (152.4mm)
- > Ribbed, neoprene jaw pads are 1.875" (47.6mm) high x 1.5" (38.1mm) wide and provide a sure grip to hold and insulate PC boards and other larger objects; reverse the pads and the wide "V" holds delicate cylindrical objects
- > Single knob controls head movement through 3-planes: 90° Tilt, 360° Turn & 360° Rotation
- > Base accepts all 300 series Heads and any 5/8" (15.9mm) diameter shaft
- > Base features 4.3125" (109.5mm) bolt circle countersunk for three 1/4" (6.3mm) flathead screws (not included)
- > **Height:** 7.3125" (185.7mm), **Weight:** 3.0 lbs. (1.4kg)

Unique Component System

Create a custom work holding tool for your specific needs with the PanaVise system of interchangeable Heads, Bases and Base Mounts. All PanaVise Bases include the patented "split-ball" which allows a Head to be positioned through 3-planes: 90° Tilt, 360° Turn & 360° Rotation. All 300 series Bases accept any 300 series Head — a multitude of useful options at your fingertips!

Heads



PV Jr. Head
Model 203



Standard Head
Model 303



Low Profile Head
Model 304



Circuit Board Holder
Model 315



Fixturing Head
Model 337



Wide Opening Head
Model 366



Extra-Wide Opening Head
Model 376



Micrometer Holder
Model 385

Bases



Low Profile Base
Model 305



Standard Base
Model 300



Vacuum Base
Model 380

Base Mounts



Weighted Base Mount
Model 308



Surface Plate Base Mount
Model 310



Bench Clamp Base Mount
Model 311



Parts Tray Base Mount
Model 312



Magnetic Base Mount
Model 335

Accessories



Jaw Pads
Models 204 & 346



Vise Jaws
Models 343, 344, 352, 353 & 354



Wire Manager
Model 358



Soldering Kit
Model 371

Vise Heads

A new Head will add extra versatility and productivity to your existing Vise, or start here to build your own custom combination! All shafts are 5/8" (15.9mm) in diameter and are compatible with the 300 Standard Base, the 305 Low-Profile Base, and the 380 Vacuum Base (page 13). All of our Vise Heads offer a lifetime of trouble-free service!

PV Jr. Head Model 203

Our most popular Vise Head for arts and crafts, model making, electronics and other small projects!

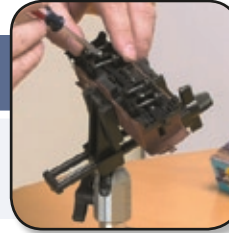

Model 203 Features:

- > We've adapted the PV Jr. Head to fit all 300 series Bases
- > Fine/coarse adjusting knob controls jaw pressure
- > Jaws feature horizontal grooves perfect for holding small tubes, rods, or small circuit boards firmly in place and are made of reinforced thermal composite plastic [continuous heat tolerance to 350°F (177°C), intermittent heat up to 450°F (204°C)]
- > Neoprene Jaw Pads (page 22) are available for holding delicate items
- > Jaws are 2" (50.8mm) tall, 1" (25.4mm) wide and open to 2.875" (73mm)
- > **Height:** 3.75" (95.2mm), **Weight:** 0.4 lbs. (0.2kg)

Standard Head Model 303

Our best selling general purpose Vise Head for hobbies, electronics and small home repairs!



Model 303 Features:

- > Jaws are 2.5" (63.5mm) wide, 0.5" (12.6mm) tall and open to 2.25" (57.1mm)
- > Nylon jaws offer excellent electrical insulation and gentle holding power [continuous heat tolerance up to 200°F (93°C), intermittent heat to 300°F (149°C)]
- > Additional jaws are available for this Head (page 22)
- > Throat depth: 1.375" (34.9mm)
- > **Height:** 4.25" (108.0mm), **Weight:** 1.5 lbs. (0.7kg)

You might consider adding...



Wire Manager Model 358

Keep your wire leads and tools organized! Slides onto 366 Wide Opening Head and 376 Extra-Wide Opening Head (page 11). See page 23 for full specifications.

Low-Profile Head Model 304

Popular for jewelry making, watch repair and lapidary work!



Model 304 Features:

- > Same basic function as the 303 Standard Head (page 10), except that the shaft is cast into the back of the Head. This allows the Head to be positioned more closely to the work surface — great for use under a magnifying light
- > When used with a 305 Low Profile Base (page 13), you can create a very low-profile Vise
- > Features steel jaws. Additional jaws are available for this Head (page 22)
- > Throat depth: 1.375" (34.9mm)
- > **Length:** 7.75" (196.8mm), **Weight:** 1.4 lbs. (0.6kg)

Wide Opening Head Model 366

Hold large objects with this general purpose Vise Head!



Model 366 Features:

- > Jaws pads are 1.875" (47.6mm) high x 1.5" (38.1mm) wide. Opens to 6" (152.4mm) with jaw pads and 6.25" (158.8mm) without jaw pads
- > Ribbed, neoprene jaw pads provide a sure grip and can hold and insulate PC boards and other larger objects; reverse the pads and the wide "V" holds delicate cylindrical objects such as coils and tuners
- > Remove jaw pads from steel jaws when working with high heat
- > Black oxide coating reduces glare and promotes eye comfort
- > **Head Length:** 11" (279.4mm)
- > **Height** (shaft to top of jaw pads): 5.125" (130.2mm), **Weight:** 1.6 lbs (0.7kg)

Extra-Wide Opening Head Model 376

Hold large, heavy objects with this general purpose Vise Head!

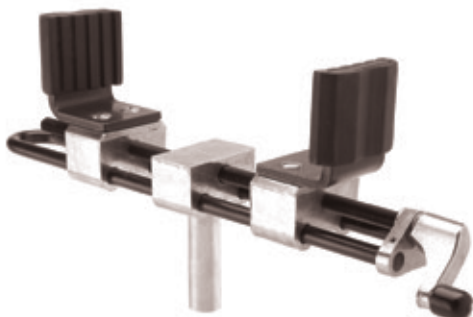

Model 376 Features:

- > Self-centering, extra-wide opening jaws open a full 9" (228.6mm) and hold heavy objects by centering weight over the base
- > Ribbed, neoprene jaw pads are 1.875" (47.6mm) high x 1.5" (38.1mm) wide and provide a sure grip; reverse the pads and the wide "V" holds round or elliptical objects
- > "Double action" jaws open/close quickly. Jaws can be reversed to provide 0" closure
- > Black oxide coating reduces glare and promotes eye comfort
- > **Head Length:** 11.5" (292.1mm)
- > **Height** (shaft to top of jaw pads): 5.25" (133.3mm), **Weight:** 1.9 lbs. (0.9kg)

Circuit Board Holder Model 315

PanaVise Circuit Board Holders help you work quicker & smarter!



Model 315 Features:

- > The two moveable arms extend 6" (154mm) from the cross bar and have "V" shaped grooves which securely hold the board edges
- > One arm is spring tensioned to equalize holding pressure, and includes a lever which locks the internal spring "open" for quick board insertion and removal
- > "V" notches positioned laterally near the arms' tips securely and conveniently hold small electronic parts
- > Shaft is 4.125" (104.8mm) long and 5/8" (15.9mm) in diameter; compatible with all 300 series Bases; accessories available (page 17)
- > **Height** (bottom of shaft to tip of arms): 10.875" (276.2mm), **Weight:** 1.0 lb. (0.5kg)

Fixturing Head Model 337

Exceptional choice for woodworkers and pattern makers!

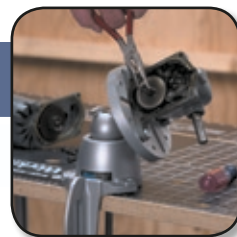
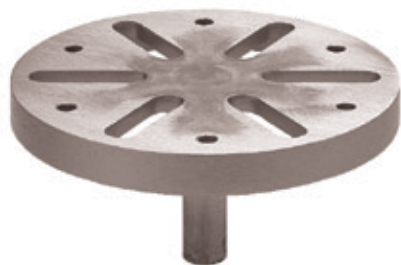

Model 337 Features:

- > Work can be attached easily to this universal Fixturing Head
- > Six slots are 0.4375" (11.1mm) wide and 1.1875" (30.2mm) long; six 0.25" (6.3mm) bolt holes are evenly spaced on a 4.375" (111.1mm) bolt circle
- > Flat surface: 5.375" (136.5mm) in diameter
- > Shaft is 4.125" (104.8mm) long and 5/8" (15.9mm) in diameter; compatible with all 300 series Bases
- > **Height** (shaft to top of head): 3.75" (95.2mm), **Weight:** 11.5oz. (1.3kg)

Micrometer Holder Model 385

Holds a micrometer or small item exactly where YOU want it!



Model 385 Features:

- > Gently, yet firmly, holds micrometers of all sizes. Can also hold small PC boards and other objects
- > Delrin® pads open 0.5" (12.7mm) and close to 0" for holding thin items
- > Throat depth: 0.95" (24.1mm)
- > **Height** (shaft to top of jaws): 3.14" (79.8mm), **Weight:** 0.23 lbs. (0.1kg)

Micrometer Stand Combination Model 391

The 385 Micrometer Holder & 305 Low-Profile Base are available as a pre-selected Micrometer Stand Combination, Model 391.

Vise Bases

Our patented "split-ball" technology is built into every 300 series Vise Base so you can easily "Tilt, Turn & Rotate" your work. Bases are compatible with all 300 series Vise Heads (pages 10-12) and accept any 5/8" (15.9mm) diameter shaft. Models 300 and 305 are compatible with all 300 series Base Mounts (pages 14-15). Mix and match to create the perfect combination!

Standard Base Model 300

Our most popular base!



Model 300 Features:

- > Accepts all 300 series Heads and any 5/8" (15.9mm) diameter shaft
- > Create a versatile work holding system by selecting two or three different Heads!
- > Single control knob and exclusive "split-ball" lock Head firmly in place
- > Base features 4.3125" (109.5mm) bolt circle countersunk for three 1/4" (6.3mm) flat-head screws (not included)
- > **Height:** 3.75" (95.2mm), **Weight:** 1.4 lbs. (0.6kg)



Low-Profile Base Model 305

Lowest Profile Base on the market!



Model 305 Features:

- > Designed for working close to the bench surface
- > Accepts all 300 series Heads and any 5/8" (15.9mm) diameter shaft
- > Use with the 304 Low-Profile Head (page 11) to create a very low-profile vise
- > Single control knob and exclusive "split-ball" locks Head firmly in place
- > Base features 4.3125" (109.5mm) bolt circle countersunk for three 1/4" (6.3mm) flat-head screws (not included)
- > **Height:** 2.5" (63.5mm), **Weight:** 1.3 lbs. (0.6kg)



Vacuum Base Model 380

Create the world's most PORTABLE work holding tool!



Model 380 Features:

- > Our Vacuum Base is in wide use for portable applications. Simply flip the lever to "activate" the rubber pad and attach the unit to any smooth, non-porous surface
- > Accepts all 300 series Heads and any 5/8" (15.9mm) diameter shaft
- > Pad footprint measures 5.125" x 4.25" (130.2mm x 108mm)
- > Single control knob and exclusive "split-ball" locks Head firmly in place
- > **Height:** 3.25" (82.5mm), **Weight:** 1.7 lbs. (0.8kg)



Vise Base Mounts

Whether you already own a 300 series Vise or are selecting components to build your own custom work holding tool, our Base Mounts will add versatility and productivity to your next PanaVise project! **All Base Mounts include three flathead mounting screws.**

Weighted Base Mount Model 308

Add portability & stability to your Vise for light duty work!

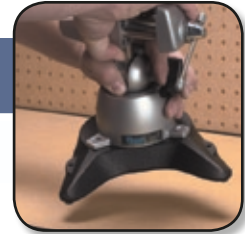

Model 308 Features:

- > This husky, cast iron Base Mount is compact and features two extensions for extra stability
- > Compatible with the 201 PV Jr. Vise (page 6) and 300 & 305 Bases (page 13)
- > Includes four non-marring, anti-skid pads
- > Two 1/4-20 holes are drilled and tapped on the side extensions for mounting accessories such as the 371 Solder Station (page 23)
- > **Overall dimensions:** 6.875" deep x 7.5" wide (174.6mm x 190.5mm)
- > **Height** (with pads): 1.1875" (30.2mm), **Weight:** 5.0 lbs. (2.3kg)

Surface Plate Base Mount Model 310

When you need a portable, stable Vise!

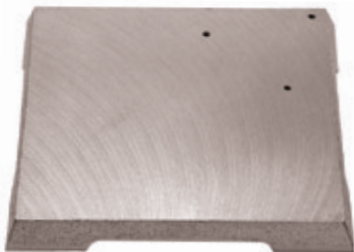

Model 310 Features:

- > The 310 Surface Plate Base Mount has a precision cast iron flat surface (Blanchard ground) which is ideal for layout work and for use as a portable work station
- > Square surface: 10.75" x 10.75" (273.1mm x 273.1mm)
- > Compatible with the 201 PV Jr. Vise (page 6) and 300 & 305 Bases (page 13)
- > Includes four non-marring, anti-skid pads
- > **Height:** 1.25" (31.8mm), **Weight:** 10.0 lbs. (4.5kg)

Bench Clamp Base Mount Model 311

Clamp your Vise to a table, workbench or ladder...



Model 311 Features:

- > Clamps to anything up to 3.4375" (87.3mm) thick
- > Compatible with the 201 PV Jr. Vise (page 6) and 300 & 305 Bases (page 13)
- > Includes four non-marring, anti-skid neoprene pads for additional anti-slip characteristics without excessive tightening of the clamping screw. Finger grip for added convenience
- > Throat depth from center of clamping screw: 2.3125" (58.7mm)
- > **Weight:** 2.4 lbs. (1.1kg)

PanaVise Base Mounts can be added to any Vise combination that includes our 300 Standard Base or our 305 Low-Profile Base; they are also compatible with the 201 PV Jr. Vise. All Base Mounts are guaranteed to deliver a lifetime of quality service!

Parts Tray Base Mount Model 312

Neatly organizes your small parts and tools!



Model 312 Features:

- > Cast aluminum Base Mount adds stability and has six integral parts wells with rounded and sloped walls for easy parts removal
- > Compatible with the 201 PV Jr. Vise (page 6) and 300 & 305 Bases (page 13)
- > Includes six non-marring, anti-skid pads
- > Three 1/4-20 holes are drilled and tapped on the outer lip for mounting accessories such as the 371 Solder Station (page 23)
- > **Overall diameter:** 8.5" (215.9mm)
- > **Height:** 0.75" (19.1mm), **Weight:** 1.9 lbs. (0.9kg)

Magnetic Base Mount Model 335

Magnetically attach your PanaVise to any flat, ferrous metal surface!



Model 335 Features:

- > Compatible with the 201 PV Jr. Vise (page 6) and 300 & 305 Bases (page 13)
- > Perfect for attaching work holding tools on machinery, truck beds, tool boxes, file cabinets... anywhere magnets are not a problem
- > Magnet is slightly recessed into Base Mount to avoid scratching metal surfaces
- > Magnetic power holds up to 5 lbs. (2.3kg) at 90°
- > **Overall diameter:** 4.32" (2.28mm)
- > **Height:** 0.5" (12.7mm), **Weight:** 1.0 lbs. (0.4kg)

You might consider adding...



Solder Station Model 371

Keep your iron and solder close at hand! Designed for use with the 312 Parts Tray Base Mount (see above) and the 308 Weighted Base Mount (see page 14). Combines a soldering iron holder, controlled-feed solder/wire holder (for standard sized spools), and two nib sponges with self-purging slits. See page 23 for full specifications.

Circuit Board Holders

The moveable arms on all PanaVise Circuit Board Holders extend 6" (152.4 mm) from the cross bar. "V" shaped grooves securely hold the board edge. The spring-tensioned arm equalizes holding pressure and the lever locks the arm open for quick board insertion and removal. "V" notches positioned near the arms' tips conveniently hold small electronic parts.

Circuit Board Holder Model 315

PanaVise Circuit Board Holders help you work quicker and smarter!



Model 315 Features:

- > Hold circuit boards up to 12" (304.8mm) wide and up to 0.156" (4mm) thick
 - Arms move independently
- > Ratcheted pivot holds board horizontally, vertically or any angle in between
- > See Circuit Board Accessories (page 17)
- > Shaft is 4.125" (104.8mm) long and 5/8" (15.9mm) in diameter; compatible with all 300 series Bases
- > **Height** (bottom of shaft to tip of arms): 10.875" (276.2mm),
- > **Weight:** 1.0 lb. (0.5kg)

Electronic Work Center Model 324

Make work areas more efficient and manageable!



Model 324 Features:

- > The PanaVise Electronic Work Center is a complete and economical work station combination
- > This practical, pre-assembled combination includes a 315 Circuit Board Holder (see above), a 300 Standard Base (page 13), a 312 Parts Tray Base Mount (page 15), and a 371 Solder Station (page 23)
- > Single control knob and exclusive "split-ball" lock the Circuit Board Holder firmly into place
- > Release the knob pressure and Circuit Board Holder Tilts 90°, Turns 360° & Rotates 360° and can be easily removed from the base. Base is compatible with all 300 series Heads (pages 10-12)
- > **Height:** 13.5" (342.9mm)
- > **Weight:** 4.5 lbs. (2kg)

All PanaVise Circuit Board Holders have plenty of head movement, including the ability to rotate quickly and easily from front to back. This makes it easy to insert and solder components, and to flip the board around for QC work. All Circuit Board Holders will provide a lifetime of superior service.

Rapid Assembly Circuit Board Holder Model 333

Speed your production work!

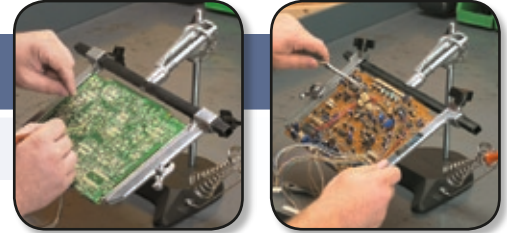

Model 333 Features:

- > For quick circuit board rotation and component insertion/soldering, the Rapid Assembly Circuit Board Holder features eight rotating adjustment positions at the head, six positive lock positions in the vertical plane, and variable height adjustment
- > Hold circuit boards up to 12" (304.8mm) wide and up to 0.156" (4mm) thick. — Arms move independently
- > "V" notches positioned laterally near the arms' tips securely and conveniently hold small electronic parts
- > 5.0 lb Weighted Base is extremely stable
- > **Height** (base to top of vertical shaft): 10" (254mm), **Weight:** 6.4 lbs. (2.9kg)

Circuit Board Accessories

Expand the capability of your PanaVise Circuit Board Holder with these outstanding accessories!

Circuit Board Arms Model 316

Add a set of arms to work on multiple boards!



- > Compatible with all Circuit Board Holders
- > Includes left and right arm
- > Arms extend 6" (152.4mm) from cross bar

Replacement Knobs Model 319

Missing a knob? Replacements are available!



- > For use with the:
315 Circuit Board Holder
333 Rapid Assembly Circuit Board Holder
324 Electronic Work Center

Circuit Board Cross Bars Models 318-14 thru 318-30

Add longer cross bars for wider circuit boards!



- > For use with the 315 Circuit Board Holder, 333 Rapid Assembly Circuit Board Holder, and 324 Electronic Work Center
- > Available in 4" (101.6mm) increments from 14" (304.8mm) to 30" (762mm)
- > When selecting a crossbar, add a minimum of 2" (50.8mm) to your widest circuit board width to accommodate Circuit Board Arms

PanaPress and Accessories

Our precision 1/4 ton (227kg) PanaPress (arbor press) is extremely useful in manufacturing or as a repair tool. By adding Retrofit Kits, you can quickly and efficiently convert a standard PanaPress into an IDC Bench Assembly Press or a Crimp Press.

PanaPress Model 502

Ideal for pressing bearings, sleeves, collars, forming and assembling small parts, broaching, staking, etc...

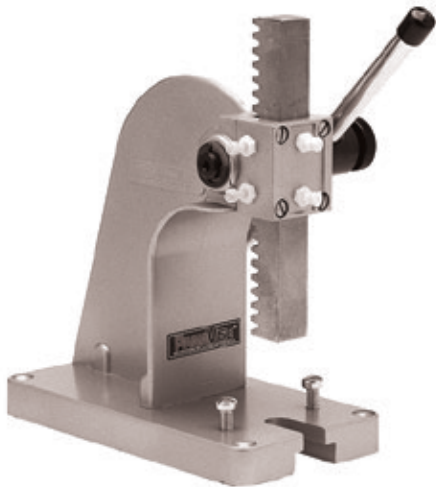
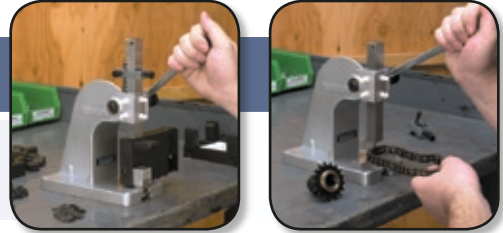

Model 502 Features:

- > Reversible ram applies up to 1/4 ton (500 lbs. / 227kg) of pressure and is 0.75" x 0.75" (19.1mm x 19.1mm) square and 5.875" (149.2mm) long
- > One end of the ram is reamed 0.251" (6.4mm) for adding tooling
- > Four adjustable nylon gibs provide exceptional ram control
- > Arm is 8" (203.2mm) long
- > Base footprint is 3.7" x 7" (94mm x 177.8mm) and includes four 0.25" (6.3mm) holes countersunk at the corners for bolting to a work surface
- > Two additional holes for mounting Retrofit Kits on the base are pre-drilled and tapped 1/4-20 and may be used for customer tooling
- > **Height** (from base to top of back – not including variable ram height or arm length): 7" (177.8mm), **Weight:** 5.4 lbs. (2.5kg)

IDC Bench Assembly Retrofit Kit Model 506

Convert any PanaPress into a rugged Insulation Displacement Connector (IDC) Assembly Press!



506 Kit installed on 502 PanaPress



Model 506 Features:

- > Perfect for independent repair technicians and in-house service departments; perfect for low volume, mass termination of various IDC connectors on ribbon cable
- > Retrofit Kit includes IDC base (for holding IDC Base Plates), ram adapter (for applying even pressure across a connector), cable guide, mounting screws and allen wrench
- > Smoothly and securely terminates up to 64-pin conductor cable
- > More effective than hand crimpers (eliminates the "scissor effect")
- > Helps prevent injuries to wrist, hands, nerves and tendons
- > Interchangeable base plates and flat ribbon cable cutter are available (page 20)

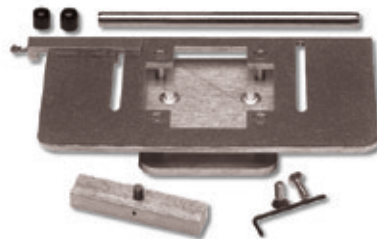

506 Retrofit Kit.
(PanaPress sold separately.)

The PanaPress can be found in a variety of work environments including manufacturing, jewelry/watch repair, and service centers. PanaPress accessories expand the capabilities of your PanaPress and will deliver a lifetime of quality service.

Crimp Press Retrofit Kit Model 561

Convert any PanaPress into a convenient Crimp Press to eliminate wrist fatigue!



561 Kit installed on 502 PanaPress



Model 561 Features:

- > Includes longer, 12" lever for increased leverage ratio over standard 502 PanaPress, crimp die holders, all mounting hardware and two allen wrenches to ease installation
- > Designed to assist in-house service departments, independent technicians, and medium-volume manufacturers

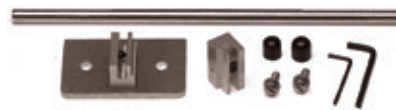

561 Retrofit Kit.
(PanaPress sold separately.)

- > Accepts all industry standard crimp die sets
- > High leverage ratio helps prevent injuries to the wrist, hands, nerves and tendons
- > More effective than hand crimpers (completely eliminates the "scissor effect")

PanaPress Posi-Stop Model 570

Adjustable Positive Stop for ALL PanaVise Presses precisely controls ram depth!

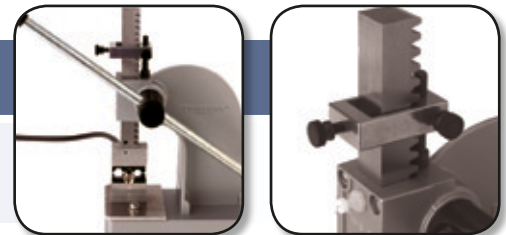

Model 570 Features:

- > Accurately controls where the ram will stop its motion
- > Quickly and easily slips over ram
- > Easy-to-use coarse adjustment firmly locks the Posi-Stop in place
- > Fine precision adjustment stops the ram exactly where you want it

Replacement Guide Arm Model 532

Add an extra guide arm when precision is critical!



- > Use two guide arms for precise cable alignment
- > Identical to the Guide Arm included with the 506 Retrofit Kit

IDC Assembly Press Accessories

A complete selection of IDC Base Plates, Cutters and Replacement Blades are available for the IDC Bench Assembly Press [(502 PanaPress with 506 Retrofit Kit (page 18)]. Useful for all independent technicians, in-house repair departments, or short run manufacturers!

IDC Base Plates Models 510-513

Interchangeable IDC Base Plates for quick cable termination!

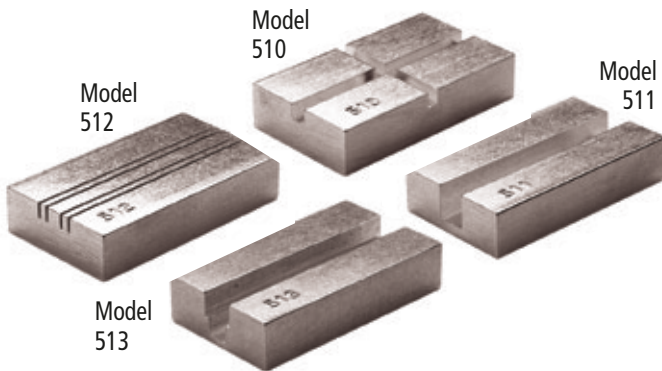

Model 510-513 Features:

- > IDC Base Plates are custom cut to hold a wide variety of connectors
- > Base Plates fit into IDC Base (included with 506 Retrofit Kit); insert and remove various Base Plates as needed

Female Socket Transition Connectors	510 series
Card Edge Connectors	511 series
DIP Plugs	512 series
D-Sub Connectors	513 series

For specific applications: call PanaVise for a dimension specification sheet which is used to determine the correct Base Plate for your needs. If you require a Base Plate that is not currently produced, call or e-mail us for information on how we can make a base plate to satisfy your requirements (Toll Free: 1.800.759.7535 -or- email: sales@panavise.com).

Flat Ribbon Cable Cutter Model 507

Perfect right angle cuts, every time!

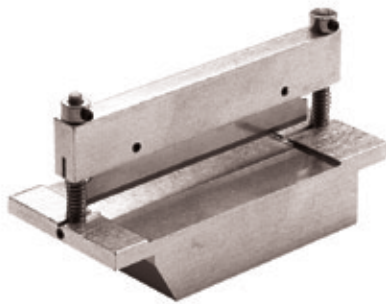

Model 507 Features:

- > Accommodates up to 68-pin conductor cable
- > More efficient than hand scissors; won't pull inner wires
- > Easy to use and operate, slips into the 502 PanaPress with the 506 Retrofit Kit
- > Spring-loaded blade arm returns quickly to original position
- > Accommodates ribbon cable up to 3.21875" (81.8mm) wide and up to 14-gauge thick



Replacement Blades Model 530

Keep a sharp edge for precision cuts!

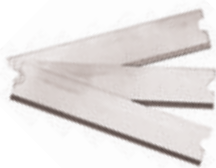

- > Replacement blades available for the 507 Cable Cutter
- > Three per blister pack

Heavy Duty Vise

For working on heavier objects such as lawn mower and electrical motors, or for wood carving and chiseling, we recommend 400 Heavy Duty Vise series components. The Heavy Duty Base provides all the "Tilt, Turn & Rotate" found in the 300 series, but with extra holding power! The Heavy Duty Head provides an exceptional work platform.

Heavy Duty Base Model 400

For heavy duty projects requiring added holding power!



Model 400 Features:

- > Recent engineering improvements allow the 400 Base to support weights up to 75 lbs. (34.0kg) at 45°
- > Recommended for use with the 437 Heavy Duty Fixturing Head (see below)
- > Accepts any 1" (25.4mm) diameter shaft to a depth of 1.7" (43.2mm)
- > Single knob controls head movement through 3-planes: 90° Tilt, 360° Turn & 360° Rotation
- > Square base [4.125" x 4.125" (104.8mm x 104.8mm)] has four 0.3125" (7.9mm) mounting holes (mounting screws not included)
- > A hole is provided in the bottom of the base for a 1/4-20 flat head screw to permanently attach any shaft
- > **Height:** 3.25" (82.5mm), **Weight:** 1.5 lbs. (0.7kg)

Heavy Duty Head Model 437

A rugged Fixturing Head for heavy duty projects!



Model 437 Features:

- > Recommended for use with the 400 Heavy Duty Base (see above)
- > Four "universal" slots 0.29" (7.37mm) wide for attaching forms, parts, etc...
- > Flat Head is 3" x 6" (76.2mm x 152.4mm)
- > Shaft is 1" (25.4mm) in diameter and 3.25" (82.5mm) long. Shaft is drilled and tapped 1/4-20 (screw included) for permanently securing to base
- > **Height** (bottom of shaft to top of head): 4" (101.6mm), **Weight:** 0.86 lbs. (0.4kg)

Vise Accessories

Thanks to ongoing customer input, we've added important accessories to our product line and have made replacement parts available. If you have an idea or suggestion for an accessory or replacement part not shown here, please contact a PanaVise representative.

Interchangeable Jaws Models 343, 344, 352-354

Interchangeable Jaws for the 303 Standard and 304 Low-Profile Heads create the perfect Vise for the job!

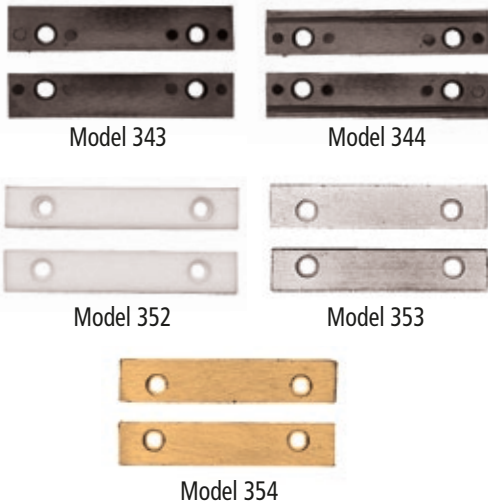

Nylon Jaws Model 343

- > Type 6/6 Nylon Jaws offer excellent electrical insulation and gentle holding power
- > Continuous heat tolerance to 200°F (93°C), intermittent heat to 300°F (149°C)

Grooved Nylon Jaws Model 344

- > Same heat properties as 343 Nylon Jaws but with thin horizontal grooves, perfect for holding small tubes, rods, or small circuit boards firmly in place

Teflon® High Heat Jaws Model 352

- > Recommended for high heat applications; won't scratch or mar delicate pieces
- > Continuous heat tolerance to 500°F (260°C)

Plated Steel Jaws Model 353

- > Designed for firmly holding heavier objects in a high heat environment

Brass Jaws Model 354

- > Non-marring alternative for heavy or high heat applications

Neoprene Jaw Pads Models 204 & 346

Neoprene Pads are soft but have plenty of holding power!

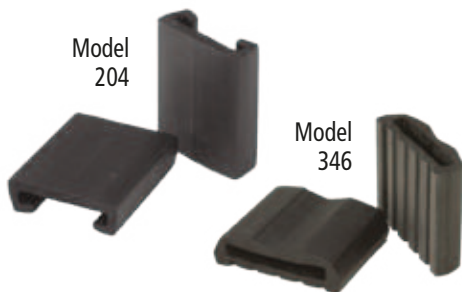

Neoprene Jaw Pads Model 204

For Models 201, 209 & 203 PV Jr. Head

- > Firmly hold your projects while protecting finished surfaces

Neoprene Jaw Pads Model 346

For Models 366 & 376 Heads

- > Thick, molded pads have a corrugated surface on one side to firmly hold the most delicate objects
- > Reverse the pads and use the wide "V" groove to hold round objects
- > Jaw Pads are 1.875" (47.63mm) wide x 1.5" (38.1mm) tall

Our Wire Manager and Solder Station are specifically designed for the electronics professional and serious hobbyist. Our goal is to make your work space more efficient — now you can take control of your wire leads and keep your soldering equipment close at hand.

Wire Manager Model 358

A handy time saver that keeps your leads and tools organized!



Model 358 Features:

- > Tempered steel spring, zinc plated
- > Pivots away from the jaws when not in use
- > Slides onto 366 Wide Opening Head and 376 Extra-Wide Opening Head (page 11)
- > **Spring width:** 3.375" (85.7mm). **Height:** 1.13" (28.7mm)



Solder Station Model 371

Keep your soldering iron and solder close at hand!



Model 371 Features:

- > Combines a soldering iron holder, controlled-feed solder/wire holder (for standard-sized spools), and two nib sponges with self-purging slits
- > Attaches easily to the 312 Parts Tray Base Mount (page 15) or to the 308 Weighted Base Mount (page 14). Mounting screws/nuts are included
- > May also be used as a freestanding unit and is easily attached to a bench or wall



Vacuum Base Repair Kit Model 380-RK

Repair your torn or damaged Vacuum Base pad!



Model 380-RK Features:

- > To determine if your Vacuum Base needs replacing, clean the pad with a clean towel and make sure that is free of debris. Then attach it to a clean, non-porous surface (such as a window). If it still loses suction, the pad needs to be replaced.
- > Includes rubber pad, handle and lock washer
- > For 380 Vacuum Base (page 13) or 381 Vacuum Base PanaVise (page 7)





CCTV Camera Mounts

> Innovative Holding Solutions™

Tilt, Turn & Rotate

Our Vises are not the only products that Tilt, Turn & Rotate! All of our CCTV camera mounts have plenty of adjustability — right out of the box. There's a camera mount for every installation requirement.

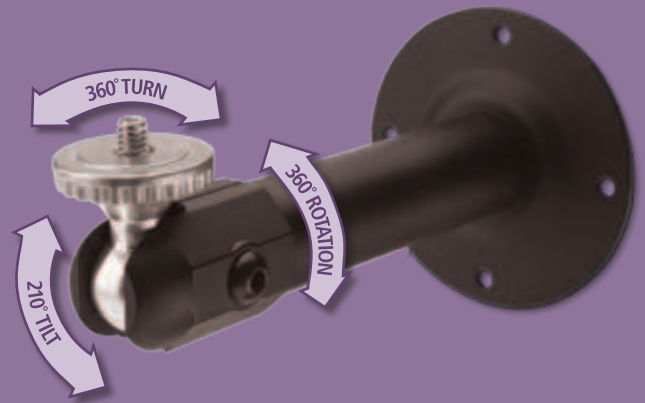

Deluxe Mounts

Our Deluxe Mounts are the only CCTV mounts with two adjusting points. Deluxe Mounts (page 30) are the most adjustable mounts on the market today!



Flex Mounts

PanaVise Flex Mounts have double-wound shafts that will stay where you put them (page 32). Perfect for navigating tricky installs.



Specialty Mounting

Our complete line of innovative CCTV Camera Mounts are designed for professional installers and will simplify the most challenging projects.



Telescoping Mounts

With PanaVise Telescoping Mounts, you can even adjust the shaft length AFTER the camera has been installed (page 31).