



Chipsmall Limited consists of a professional team with an average of over 10 year of expertise in the distribution of electronic components. Based in Hongkong, we have already established firm and mutual-benefit business relationships with customers from,Europe,America and south Asia,supplying obsolete and hard-to-find components to meet their specific needs.

With the principle of “Quality Parts,Customers Priority,Honest Operation,and Considerate Service”,our business mainly focus on the distribution of electronic components. Line cards we deal with include Microchip,ALPS,ROHM,Xilinx,Pulse,ON,Everlight and Freescale. Main products comprise IC,Modules,Potentiometer,IC Socket,Relay,Connector.Our parts cover such applications as commercial,industrial, and automotives areas.

We are looking forward to setting up business relationship with you and hope to provide you with the best service and solution. Let us make a better world for our industry!



Contact us

Tel: +86-755-8981 8866 Fax: +86-755-8427 6832

Email & Skype: info@chipsmall.com Web: www.chipsmall.com

Address: A1208, Overseas Decoration Building, #122 Zhenhua RD., Futian, Shenzhen, China



SURFACE MOUNT AUDIO JACKS

- Mates with 2.5mm and 3.5mm plugs
- Designed for reliable interface with audio equipment including computer speakers, headphones, sound cards, cell phones, etc.
- Models available for mono and stereo applications
- Low profile, surface mount design



SPECIFICATIONS

Housing: Polyamide, UL Rated 94V-0
Ground Terminal: .012 (.30) Brass, Gold Flash ①
Spring Contacts: .008 (.20) Phosphor Bronze, Gold Flash ② ⑤
Shunt Terminals: .012 (.30) Brass, Gold flash ③ ④

FOR 2.5 mm PLUGS

SUPPLIED ON TAPE AND REEL

FOR 3.5 mm PLUGS

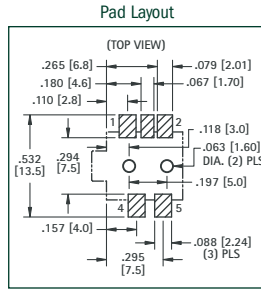
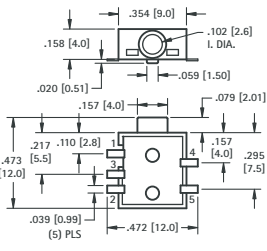

STEREO SCHEMATIC

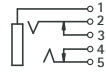

MONO SCHEMATIC

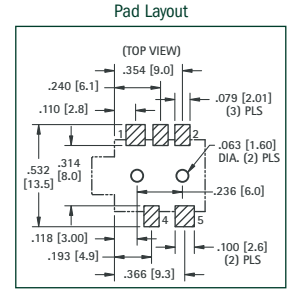
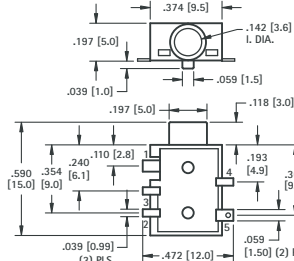
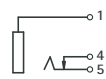

CAT. NO. 980TR (Stereo)

CAT. NO. 982TR (Mono)

Tape Spec's: 24mm wide; 16mm pitch
Reel Spec's: 15 inch reel (1,000 pieces per reel)

CAT. NO. 981TR (Stereo)

CAT. NO. 983TR (Mono)

Tape Spec's: 24mm wide; 16mm pitch
Reel Spec's: 15 inch reel (800 pieces per reel)

BINDING POSTS

All Keystone binding posts are designed to prevent accidental contact with current carrying parts. They feature a "limited opening" captivated head to insure safety. Ideal for audio circuitry, R.F. circuitry, oscilloscopes, power supplies and various other applications.

These multi-purpose binding posts feature high current rating, captivated heads and anti-rotation stud mounting.

Note: Binding Posts accept .175" (4.5) Banana Plugs, .080" (2.08) Tip Plugs, Spade Lugs, Alligator Clips, Wires and EZ hooks.

STANDARD BINDING POST

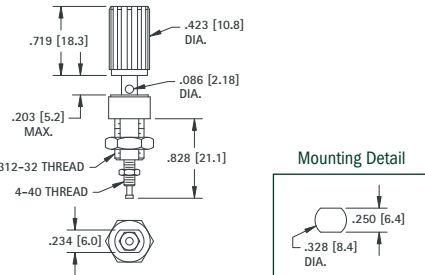

For panels up to .281 (7.1) thick

CAT. NO.	COLOR
7004	RED
7005	BLACK

MATERIAL:

Stud: Brass per QQ-B-626
Plating: Silver Plate
Insulation: Nylon
Current Rating: 15 Amps
Stud to Panel Capacitance: 3.3 pF Nominal

UNINSULATED BINDING POST

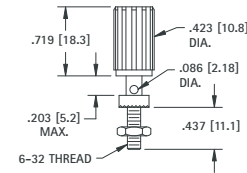

For panels up to .313 (8.0) thick

CAT. NO.	COLOR
7006	RED
7007	BLACK

MATERIAL:

Stud: Brass per QQ-B-626
Plating: Nickel Plate
Insulation: Nylon
Current Rating: 15 Amps, 1000V AC Working

STANDARD DUAL HEX HEAD

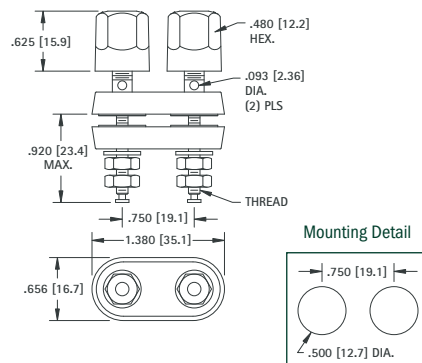

GOLD PLATE		NICKEL PLATE	
CAT. NO.	THREAD	CAT. NO.	THREAD
4108	8-32	7018	8-32
4109	10-32	7019	10-32

MATERIAL:

Stud: Brass per ASTM B-16.
Insulation: Nylon
Current Rating: 30 Amps, 1000V AC Working

STANDARD HEX HEAD

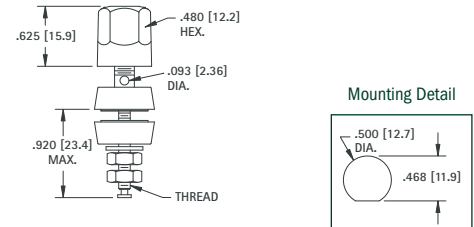

GOLD PLATE			NICKEL PLATE		
CAT. NO.	THREAD	COLOR	CAT. NO.	THREAD	COLOR
4096	8-32	RED	4091	8-32	RED
4097	8-32	BLACK	4092	8-32	BLACK
7016	10-32	RED	4093	10-32	RED
7017	10-32	BLACK	4094	10-32	BLACK
7023	10-32	WHITE	4198	10-32	WHITE
7024	10-32	YELLOW	4199	10-32	YELLOW

MATERIAL:

Stud: Brass per ASTM B-16.
Insulation: Nylon
Current Rating: 30 Amps, 1000V AC Working