



Chipsmall Limited consists of a professional team with an average of over 10 year of expertise in the distribution of electronic components. Based in Hongkong, we have already established firm and mutual-benefit business relationships with customers from,Europe,America and south Asia,supplying obsolete and hard-to-find components to meet their specific needs.

With the principle of “Quality Parts,Customers Priority,Honest Operation,and Considerate Service”,our business mainly focus on the distribution of electronic components. Line cards we deal with include Microchip,ALPS,ROHM,Xilinx,Pulse,ON,Everlight and Freescale. Main products comprise IC,Modules,Potentiometer,IC Socket,Relay,Connector.Our parts cover such applications as commercial,industrial, and automotives areas.

We are looking forward to setting up business relationship with you and hope to provide you with the best service and solution. Let us make a better world for our industry!



Contact us

Tel: +86-755-8981 8866 Fax: +86-755-8427 6832

Email & Skype: info@chipsmall.com Web: www.chipsmall.com

Address: A1208, Overseas Decoration Building, #122 Zhenhua RD., Futian, Shenzhen, China



Introduction – Electronic Circuit Protection ESX10-T

Electronic circuit protection type ESX10-T is designed to ensure selective disconnection of 24VDC load systems.

24VDC power supplies, which are widely used in industry today, will shut down the output in the event of an overload with the result that one faulty load in the system can lead to complete disconnection of all loads.

Through selective disconnection the ESX10-T responds much faster to overload or short circuit conditions than the switch-mode power supply. This is achieved by active current limitation. The ESX10-T limits the highest possible current to 1.3 to 1.8 times the selected rated current of the circuit protector. Thus it is possible to switch on capacitive loads of up to 20,000 μ F, but they are disconnected only in the event of an overload or short circuit.

For optimal alignment with the characteristics of the application the current rating of the ESX10-T can be selected in fixed values from 0.5 A...12 A. Failure and status indication are provided by a multicolour LED and an integral short-circuit-proof status output or a relay signal contact. Remote operation is possible by means of a remote reset signal or a remote ON/OFF control signal. The manual ON/OFF button allows separate actuation and reset of individual load circuits.

Upon detection of overload or short circuit in the load circuit, the MOSFET of the load output will be blocked to interrupt the current flow. The load circuit can be re-activated via the remote electronic reset input, control input or manually by means of the ON/OFF button.

Features

- Selective load protection, electronic trip characteristics
- Active current limitation for safe connection of capacitive loads up to 20,000 μ F and on overload/short circuit
- Current ratings 0.5 A...12 A
- Reliable overload disconnection with $1.1 \times I_n$ plus, even with long load lines or small cable cross sections (see table 3)
- Manual ON/OFF button (S1)
- Control input IN+ for remote ON/OFF signal (option)
- Electronic **reset** input RE (option)
- Clear status and failure indication through LED, status output SF or Si contact F
- Integral fail-safe element adjusted to current rating
- Width per unit only 12.5 mm
- Rail mounting
- Ease of wiring through busbar LINE+ and 0 V as well as signal bars and bridges
- UL/CSA Hazardous area approved—Class 1, Div 2



Approvals

Authority	Voltage rating	Current ratings
UL2367 (E306740)	24VDC	0.5...12 A
UL1604 (E322549)	24VDC	0.5...12 A
(class 1, div. 2, group A, B, C, D)		
UL508/ cUL 508	24VDC	0.5...12 A
CSA file 165971:		
CSA C22.2 No: 213 (class I, div. 2)	24VDC	0.5...12 A
Groups A, B, C, D, T5		
CSA C22.2 No: 142	24VDC	0.5...12 A
Class 2		
Meets requirements for Class 2 current limitation		
(ESX10-T... 0.5 A / 1 A / 2 A / 3 A		

Technical data (T_{ambient} = 40°C, operating voltage U_B = 24VDC)

Operating data

Operating voltage U _B	24VDC (18...32 V)
Current rating I _N	fixed current ratings: 0.5, 1 A, 2 A, 3 A, 4 A, 6 A, 8 A, 10 A, 12 A
Closed current I _Q	ON condition: typically 20...30 mA depending on signal output
Status indication by means of	<ul style="list-style-type: none"> • multicolour LED: GREEN: unit is ON, power-MOSFET is switched on - status output SF ON, supplies + 24VDC ORANGE: in the event of overload or short circuit until electronic disconnection RED: - unit electronically disconnected - load circuit/Power-MOSFET OFF OFF: - manually switched off (S1 = OFF) - or device is dead - undervoltage (U_B < 8 V) - after switch-on till the end of the delay period <ul style="list-style-type: none"> • status output SF (option) • potential-free signal contact F (option) • ON/OFF/ condition of switch S1

Load circuit

Load output	Power-MOSFET switching output (high side switch)
Overload disconnection	typically 1.1 x I _N (1.05...1.35 x I _N)
Short-circuit current I _K	active current limitation (see table 1)
Trip time for electronic disconnection	see time/current characteristics typically 3 s at I _{Load} > 1.1 x I _N typically 3 s...100 ms at I _{Load} > 1.8 x I _N (or 1.5 x I _N /1.3 x I _N)
Temperature disconnection	internal temperature monitoring with electronic disconnection
Low voltage monitoring load output	with hysteresis, no reset required load "OFF" at U _B < 8 V
Starting delay t _{start}	typically 0.5 sec after every switch-on and after applying U _B
Disconnection of load circuit	electronic disconnection
Free-wheeling circuit	external free-wheeling diode recommended with inductive load
Several load outputs must not be connected in parallel	

Technical data (T_{ambient} = 40°C, operating voltage U_B = 24VDC)

Status output SF	ESX10-TB-114/-124/
Electrical data	plus-switching signal output, connects U _B to terminal 12 of module 17plus nominal data: 24VDC / max. 0.2 A (short circuit proof) status output is internally connected to GND with a 10 kOhm resistor
Status OUT	ESX10-TB-114/-124 (signal status OUT), at U _B = +24 V +24 V = S1 is ON, load output connected through 0V = S1 is ON, load output blocked and/or switch S1 is OFF red LED lit
OFF condition	0 V level at status output when: <ul style="list-style-type: none"> • switch S1 is in ON position, but device is still in switch-on delay • switch S1 is OFF, or control signal OFF, device is switched off • no operating voltage U_B
Signal output F	ESX10-TB-101/-102
Electrical data	potential-free signal contact max. 30VDC/0.5 A, min. 10 V/10 mA
ON condition LED green	voltage U _B applied, switch S1 is in ON position no overload, no short circuit
OFF condition LED off	<ul style="list-style-type: none"> • device switched off (switch S1 is in OFF position) • no voltage U_B applied
Fault condition LED orange	overload condition > 1.1 x I _N up to electronic disconnection
Fault condition LED red	electronic disconnection upon overload or short circuit device switched off with control signal (switch S1 is in ON position)
ESX10-TB-101	single signal, make contact contact SC/SO-SI open
ESX10-TB-102	single signal, break contact contact SC/SO-SI closed
Fault	signal output fault conditions: <ul style="list-style-type: none"> • no operating voltage U_B • ON/OFF switch S1 is in OFF position • red LED lighted (electronic disconnection)
Reset input RE	ESX10-TB-124
Electrical data	voltage: max. +32VDC high > 8VDC ≤ 32VDC low ≤ 3VDC > 0 V power consumption typically 2.6 mA (+24VDC) min. pulse duration typically 10 ms
Reset signal RE (terminal 22)	The electronically blocked ESX10-TB-124 may remotely be reset via an external momentary switch due to the falling edge of a +24 V pulse. A common reset signal can be applied to several devices simultaneously. Switched on devices remain unaffected.
Control input IN+	ESX10-TB-114
Electrical data	see reset input RE
Control signal IN+ (terminal 21)	+24V level (HIGH): device will be switched on by a remote ON/OFF signal 0 V level (LOW): device will be switched off by a remote ON/OFF signal
Switch S1 ON/OFF	unit can only be switched on with S1 if a HIGH level is applied to IN+

Electronic Circuit Protection ESX10-T

Technical data (T_{ambient} = 40°C, operating voltage U_b = 24VDC)

General data		Mounting	
Fail-safe element:	backup fuse for ESX10-T <u>not required</u> because of the integral redundant fail-safe element		symmetrical rail to EN 50022-35x7.5
Terminals LINE+ / LOAD+ / 0V		Ambient temperature	0...+50 °C (without condensation, see EN 60204-1)
screw terminals		Storage temperature	-20...+70 °C
max. cable cross section		Humidity	96 hrs/95 % RH/40 °C to IEC 60068-2-78-Cab climate class 3K3 to EN 60721
flexible with wire end ferrule w/wo plastic sleeve	20-6 AWG (0.5 - 10 mm ²)	Vibration	3 g, test to IEC 68-2-6 test Fc
multi-lead connection (2 identical cables)		Degree of protection	housing: IP20 DIN 40050 terminals: IP20 DIN 40050
rigid/flexible	20-11 AWG (0.5 - 4 mm ²)	EMC	emission: EN 61000-6-3
flexible with wire end ferrule without plastic sleeve	20-13 AWG (0.5 - 2.5 mm ²)	(EMC directive, CE logo)	susceptibility: EN 61000-6-2
flexible with TWIN wire end ferrule with plastic sleeve	20-9 AWG (0.5 - 6 mm ²)	Insulation co-ordination (IEC 60934)	0.5 kV/2 pollution degree 2 re-reinforced insulation in operating area
wire stripping length	10 mm	dielectric strength	max. 32VDC (load circuit)
tightening torque (EN 60934)	1.2 Nm	Insulation resistance (OFF condition)	n/a, only electronic disconnection
Terminals aux. contacts		Approvals	UL2367, File E306740, Solid State Overcurrent Protectors
screw terminals			UL1604 (class I, div. 2, zone 2), UL508, CE logo
max. cable cross section			CSA C22.2 No. 142 - file 165971, C22.2 No. 213 - file 165971, C1D2 Groups A, B, C, D, Temp Code T5; Ambient 0°-40°C
flexible with wire end ferrule w/wo plastic sleeve	23-13 AWG (0.25 - 2.5 mm ²)	Dimensions (W x H x D)	12.5 x 80 x 83 mm
wire stripping length	8 mm	Mass	approx. 65 g
tightening torque (EN 60934)	0.5 Nm		
Housing material	moulded		

Table 1:
voltage drop, current limitation, max. load current

current rating I _N	typically voltage drop U _{ON} at I _N	active current limitation (typically)	max. load current at 100% ON duty	
			T _U = 40 °C	T _U = 50 °C
0.5 A	70 mV	1.8 x I _N	0.5 A	0.5 A
1 A	80 mV	1.8 x I _N	1 A	1 A
2 A	130 mV	1.8 x I _N	2 A	2 A
3 A	80 mV	1.8 x I _N	3 A	3 A
4 A	100 mV	1.8 x I _N	4 A	4 A
6 A	130 mV	1.8 x I _N	6 A	5 A
8 A	120 mV	1.5 x I _N	8 A	7 A
10 A	150 mV	1.5 x I _N	10 A	9 A
12 A	180 mV	1.3 x I _N	12 A	10.8 A

Attention: when mounted side-by-side without convection the ESX10-T should not carry more than 80% of its rated load with 100% ON duty due to thermal effects.

Please note:

- The user should ensure that the cable cross sections of the relevant load circuit are suitable for the current rating of the ESX10-T used.
- Automatic start-up of machinery after shut down must be prevented (Machinery Directive 98/37/EG and EN 60204-1). In the event of a short circuit or overload the load circuit will be disconnected electronically by the ESX10-T.
- Refer to UL/CSA file for proper wiring and installation techniques.

Table 2: ESX10-T - Ordering Information

Version	Signal input			Signal output					
	without Signal Input	Control input ON/OFF Reset	Remote Reset	without Signal Output	single signal N/O (normally open NO)	single signal N/C (normally closed NC)	without Signal Output	Status OUT Positive 24V = OK	Status OUT ØV = OK
ESX10-TA-100	x			x			x		
ESX10-TB-101	x				x		x		
ESX10-TB-102	x					x	x		
ESX10-TB-114		x						x	
ESX10-TB-124			x	x				x	
ESX10-TB-127			x	x					x

ESX10-TA-100		ESX10-TB-101		ESX10-TB-102		ESX10-TB-114*		ESX10-TB-124**		ESX10-TB-127	
Current Rating (amps)	Circuit Protection Part Number	Current Rating (amps)	N/O Contact Part Number	Current Rating (amps)	N/C Contact Part Number	Current Rating (amps)	Control Input Part Number	Current Rating (amps)	Reset Input Part Number	Current Rating (amps)	Reset Input Part Number
0.5	6720005305	0.5	6720005320	0.5	6720005340	0.5	6720005360	0.5	6720005380	0.5	6720005309
1	6720005301	1	6720005321	1	6720005341	1	6720005361	1	6720005381	1	6720005319
2	6720005302	2	6720005322	2	6720005342	2	6720005362	2	6720005382	2	6720005329
3	6720005303	3	6720005323	3	6720005343	3	6720005363	3	6720005383	3	6720005339
4	6720005304	4	6720005324	4	6720005344	4	6720005364	4	6720005384	4	6720005349
6	6720005306	6	6720005326	6	6720005346	6	6720005366	6	6720005386	6	6720005369
8	6720005308	8	6720005328	8	6720005348	8	6720005368	8	6720005388	8	6720005389
10	6720005310	10	6720005330	10	6720005350	10	6720005370	10	6720005390	10	6720005399
12	6720005312	12	6720005332	12	6720005352	12	6720005372	12	6720005392	12	6720005313

* Control force input on/off ** Reset input only to reset under fault conditions

ESX10-T Signal inputs / outputs (wiring diagram)

ESX10-TA-100
without signal input/output

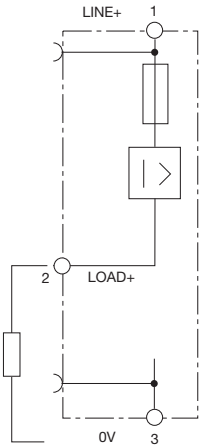

ESX10-TB-101
without signal input
with signal output F
(single signal, N/O)

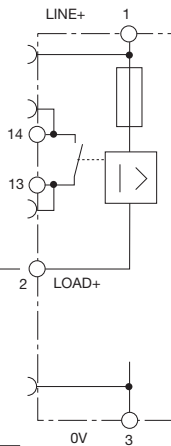

operating condition: 13-14 closed
fault condition: 13-14 open

ESX10-TB-102
without signal input
with signal output F
(single signal, N/C)

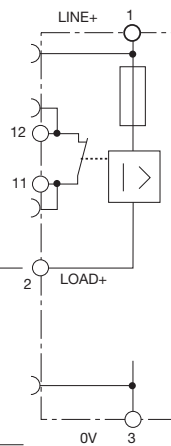

operating condition: 11-12 open
fault condition: 11-12 closed

ESX10-TB-114
with control input IN+
(+24VDC)
with status output SF
(+24 V = load output ON)

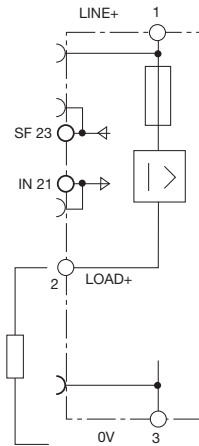

operating condition: SF +24 V = OK
fault condition: SF 0 V

ESX10-TB-124
with reset input RE
(+24VDC ↓)
with status output SF
(+24 V = load output ON)

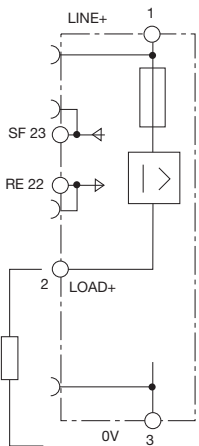

operating condition: SF +24 V = O
fault condition: SF 0 V

ESX10-TB-127
with reset input RE
(+DC 24 V ↓)
with inverse status output SF
(0 V = load output ON)

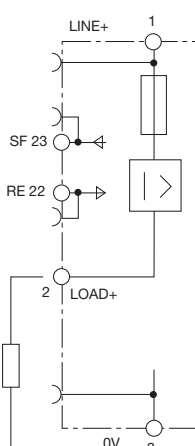

operating condition: SF 0 V = OK
fault condition: SF +24 V

Dimensions

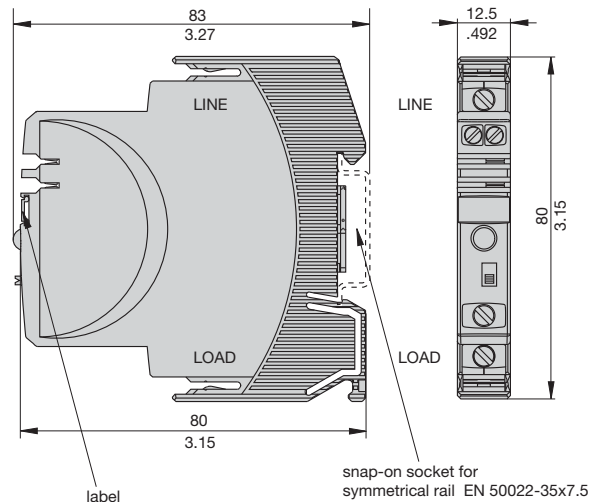

snap-on socket for symmetrical rail EN 50022-35x7.5

This is a metric design and millimeter dimensions take precedence ($\frac{\text{mm}}{\text{inch}}$)

Electronic Circuit Protection ESX10-T

Time/Current characteristic curve (T_a = 25 °C)

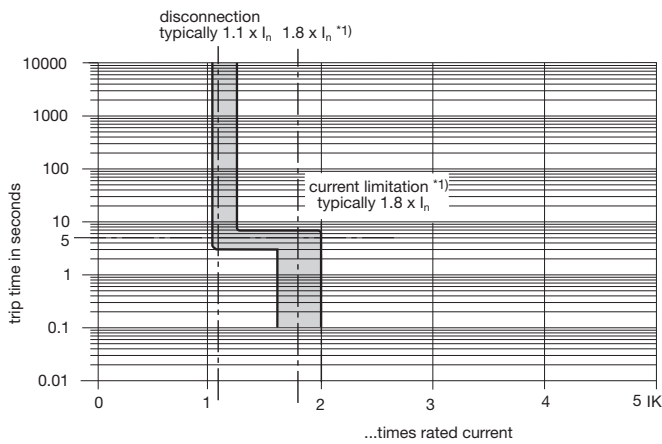

- The trip time is typically 3 s in the range between 1.1 and 1.8 x I_n^{**1)}.
- Electronic current limitation occurs at typically 1.8 x I_n^{**1)} which means that under all overload conditions (independent of the power supply and the resistance of the load circuit) the max. overload before disconnection will not exceed 1.8 x I_n^{**1)} times the current rating. Trip time is between 100 ms and 3 sec (depending on overload or at short circuit).
- Without this current limitation a considerably higher overload current would flow in the event of an overload or short circuit.

^{**1)} current limitation typically 1.8 x I_n times rated current at I_n = 0.5 A...6 A
 current limitation typically 1.5 x I_n times rated current at I_n = 8 A or 10 A
 current limitation typically 1.3 x I_n times rated current at I_n = 12 A

Table 3: Reliable trip of ESX10-T

Reliable trip of ESX10-T with different cable lengths and cross sections								
Resistivity of copper ρ ₀ =	0.0178 (Ohm x mm ²) / m							
U _b = DC 19.2 V (= 80 % of 24 V)	voltage drop of ESX10-T and tolerance of trip point (typically 1.1 x I _n = 1.05 ... 1.35 x I _n) have been taken into account.							
ESX10-T-selected rating I _n (in A)	→ 3	6	→ ESX10-T trips after 3 s					
e. g. trip current I _{ab} = 1.25 x I _n (in A)	→ 3.75	7.5						
R _{max} in Ohm = (U _b / I _{ab}) - 0.050	→ 5.07	2.51						
The ESX10-T reliably trips from 0 Ohm to max. circuitry resistance R_{max}								
	Cable cross section A in mm ²	0.14	0.25	0.34	0.5	0.75	1	1.5
	cable length L in meter (= single length)	cable resistance in Ohm = (R ₀ x 2 x L) / A						
	↓	↓	↓	↓	↓	↓	↓	↓
	5	1.27	0.71	0.52	0.36	0.24	0.18	0.12
	10	2.54	1.42	1.05	0.71	0.47	0.36	0.24
	15	3.81	2.14	1.57	1.07	0.71	0.53	0.36
	20	5.09	2.85	2.09	1.42	0.95	0.71	0.47
	25	6.36	3.56	2.62	1.78	1.19	0.89	0.59
	30	7.63	4.27	3.14	2.14	1.42	1.07	0.71
	35	8.90	4.98	3.66	2.49	1.66	1.25	0.83
	40	10.17	5.70	4.19	2.85	1.90	1.42	0.95
	45	11.44	6.41	4.71	3.20	2.14	1.60	1.07
	50	12.71	7.12	5.24	3.56	2.37	1.78	1.19
	75	19.07	10.68	7.85	5.34	3.56	2.67	1.78
	100	25.34	14.24	10.47	7.12	4.75	3.56	2.37
	125	31.79	17.80	13.09	8.90	5.93	4.45	2.97
	150	38.14	21.36	15.71	10.68	7.12	5.34	3.56
	175	44.50	24.92	18.32	12.46	8.31	6.23	4.15
	200	50.86	28.48	20.94	14.24	9.49	7.12	4.75
	225	57.21	32.04	23.56	16.02	10.68	8.01	5.34
	250	→ 63.57	→ 35.60	→ 26.18	→ 17.80	→ 11.87	→ 8.90	→ 5.93
Example 1:	max. length at 1.5 mm ² and 3 A	214 m		→				
Example 2:	max. length at 1.5 mm ² and 6 A	106 m		→				
Example 3:	mixed wiring: (Control cabinet – sensor/actuator level)	R1 = 40 m in 1.5 mm ² and R2 = 5 m in 0.25 mm ² : R1 = 0.95 Ohm, R2 = 0.71 Ohm		Total (R1 + R2) = 1.66 Ohm				

Mounting examples for ESX10-T

The ESX10-T features an integral power distribution system.

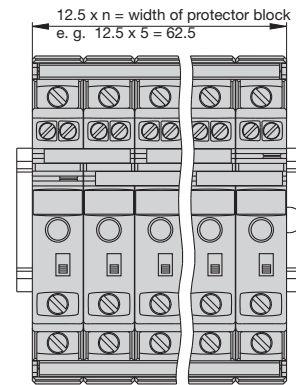
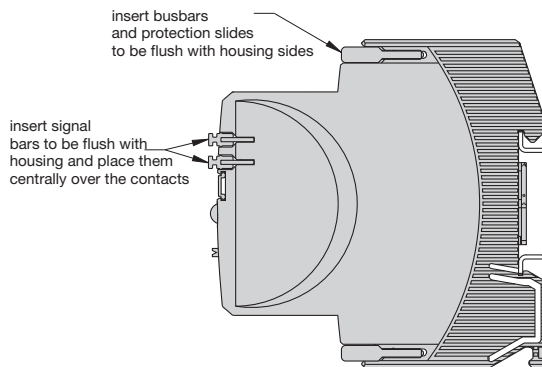
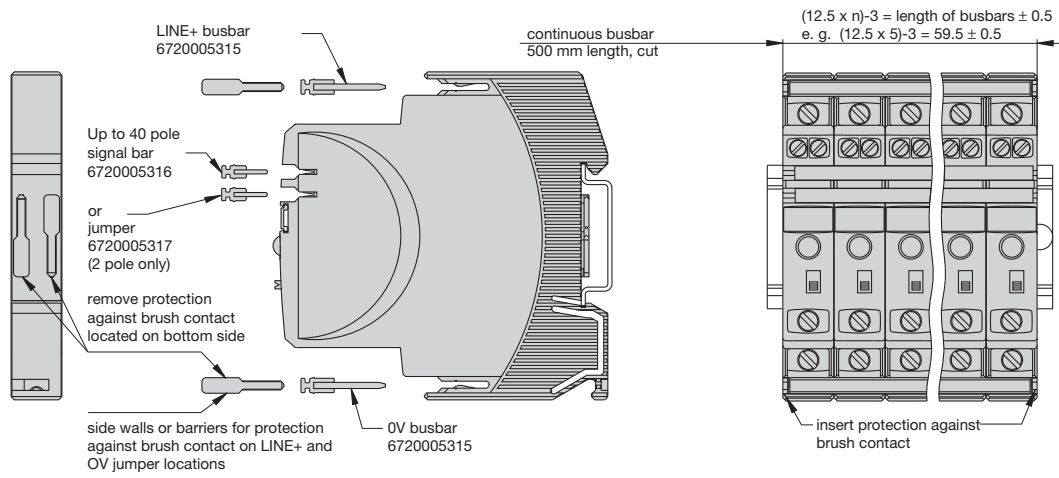

5 ESX10-TB
with busbars
and jumpers

5 ESX10-TA
with busbars

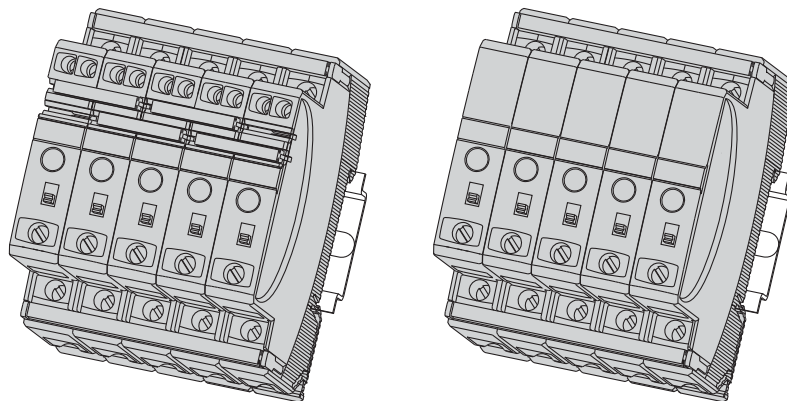

Mounting procedure:

Before wiring insert busbars into protection block.

Electronic Circuit Protection ESX10-T

Connection diagrams and application examples ESX10-T

Signal contacts are shown in OFF or fault condition.

ESX10-TA-100

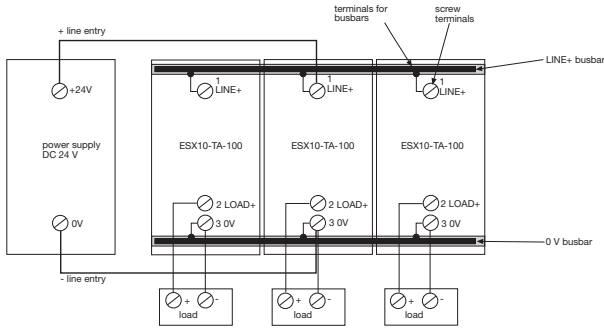

ESX10-TB-101

group signaling (series connection)

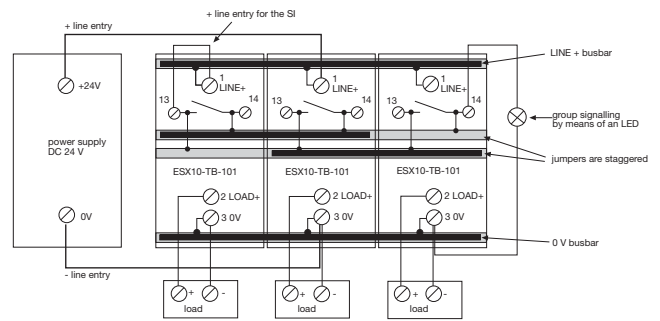

ESX10-TB-102

Single signaling with common line entry

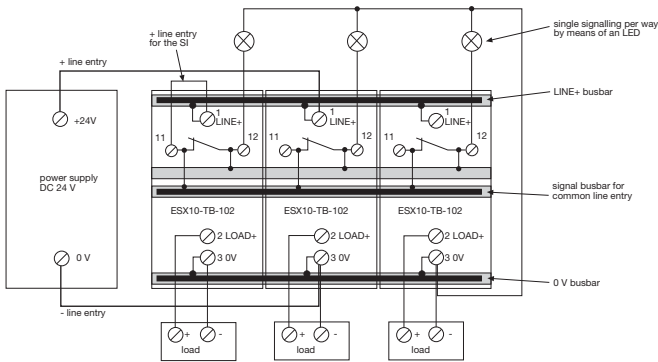

ESX10-TB-124

Single signaling with common reset

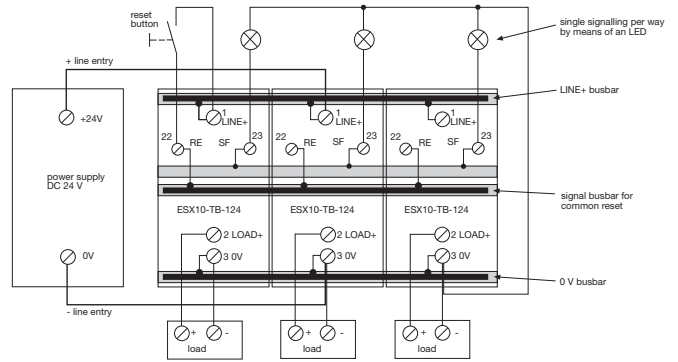

Accessories for ESX10-T

Description

The ESX10-T features an integral power distribution system. The following wiring modes are possible with various plug-gable current and signal busbars:

- LINE +(24VDC)
- 0 V

Caution: The electronic devices ESX10-T require a 0 V connection

- signal contacts
- reset inputs

Description	Part No.	
Busbars for LINE+ and 0 V	6720005315	
max. load with one line entry (recommended: centre line entry)	I _{max}	50 A
max. load with two line entries	I _{max}	63 A
length:	500 mm	
<hr/>		
Signal busbars for signal contacts and reset inputs	6720005316	
max. load with one line entry	I _{max}	1 A
with one series connection of signal contacts	I _{max}	0.5 A
length:	500 mm	
<hr/>		
Jumpers for signal contacts	6720005317	
length:	21 mm	
packing unit:	10 pcs	
<hr/>		
TS32 rail adapter	9102100000	
(Remove protection walls/barriers before using adapter.)		

For detailed installation instructions and approvals contact Weidmüller at 1-800-849-9343 or go to www.weidmuller.com

Introduction – Circuit Protection

Weidmüller's DIN-rail mounted circuit breakers are available for use in applications where circuit protection must be able to distinguish between circuit overloads and short circuits. Each circuit breaker has the ability to be reset without the need to change components. All circuit breakers are available with an assortment of jumpers and marking tags.

Circuit breakers in the 9926 Series are cULus listed according to UL489 and CSA 22.2 No. 5.02, CE, VDE. The hydraulic magnetic trip mechanism offers 10,000A of interrupting capacity in 120V and 240V, 50/60Hz applications.



9926 Series

The CB2200 Series feature integrated alarm contacts within a narrow profile, thereby allowing increased enclosure capacity. All of these circuit breakers demonstrate consistent reliability through 100% calibration and testing, and feature a touch safe design to prevent injury from accidental contact with live components.



CB2200 Series

The CB4200 Series of thermal magnetic circuit breakers feature a push-button style of trip reset. This reset provides a visual indication of status which allows for rapid troubleshooting.



CB4200 Series

The CB9100 Series of thermal magnetic circuit breakers provide a rugged and industry-standard form factor (18 mm/pole). For supplemental circuit protection.



CB9100 Series

9926 Series Branch Rated Circuit Breakers–AC Version

Circuit Breakers Hydraulic Magnetic Type

- Single pole and double pole versions
- 120/240 VAC, 50/60 Hz
- Up to 25A
- Just 13 mm wide
- Mounts on 35mm DIN-rail
- cULus listed according to UL489 CSA C22.2 No. 5.02, CE, VDE

9926 Series Single Pole



9926 Series Double Pole



Ordering Data

Ordering Data	

Type: Single Pole (up to 120 VAC)

Current Ratings (amps)	Part No.	Description
0.5	9926251000	QL-1-13-DM-KM-0.5
1	9926251001	QL-1-13-DM-KM-01
2	9926251002	QL-1-13-DM-KM-02
3	9926251003	QL-1-13-DM-KM-03
4	9926251004	QL-1-13-DM-KM-04
5	9926251005	QL-1-13-DM-KM-05
6	9926251006	QL-1-13-DM-KM-06
7	9926251007	QL-1-13-DM-KM-07
8	9926251008	QL-1-13-DM-KM-08
10	9926251010	QL-1-13-DM-KM-10
13	9926251013	QL-1-13-DM-KM-13
15	9926251015	QL-1-13-DM-KM-15
16	9926251016	QL-1-13-DM-KM-16
20	9926251020	QL-1-13-DM-KM-20
25	9926251025	QL-1-13-DM-KM-25

Type: Double Pole (up to 240 VAC)

Current Ratings (amps)	Part No.	Description
0.5	9926252000	QL-2-13-DM-KM-0.5
1	9926252001	QL-2-13-DM-KM-01
2	9926252002	QL-2-13-DM-KM-02
3	9926252003	QL-2-13-DM-KM-03
4	9926252004	QL-2-13-DM-KM-04
5	9926252005	QL-2-13-DM-KM-05
6	9926252006	QL-2-13-DM-KM-06
7	9926252007	QL-2-13-DM-KM-07
8	9926252008	QL-2-13-DM-KM-08
10	9926252010	QL-2-13-DM-KM-10
13	9926252013	QL-2-13-DM-KM-13
15	9926252015	QL-2-13-DM-KM-15
16	9926252016	QL-2-13-DM-KM-16
20	9926252020	QL-2-13-DM-KM-20
25	9926252025	QL-2-13-DM-KM-25

Technical Data

Voltage	120/240 VAC, 50/60Hz
Current	
minimum	0.5A
maximum	25A
Interrupting capacity	10,000A
Dielectric strength	1500V, 50/60Hz
Insulation resistance	100MΩ
Operating life	10000 mechanical operations
Operating temperature	-40...+65°C
Wire size*	
0.5-15A:	14AWG min., 10AWG max.
20-25A:	10AWG min.
Torque	20 in.-lb

Approval

cULus listed according to UL489 CSA C22.2 No. 5.02, CE, VDE

Accessories

Accessories	Part No.
Bus-bar (1 pole, insulated, 1 m)	67101904
Bus-bar (2 pole, insulated, 1 m)	67101972
Bus-bar end cap, 1 pole	67101973
Bus-bar end cap, 2 pole	67101974
Power lug, straight	67101960
Power lug, 90°	67101961
Lock-out handle	67101913

*Wire sizes: gauges specified are the minimum allowable as per CSA and UL standards.

The 9926 circuit breakers do not have provisions for marking tags. A possible solution is to cut the adhesive SchS2 tag rail to length (approximately 20 mm on a single pole unit so the current rating remains visible or approximately 30 mm on a two pole unit). The SchS2 accepts DEK, WS and ESG 8/17 marking tags. The part number for adhesive SchS2 is 1720600000.

Trip Curves—Hydraulic Magnetic Type Typical time/current characteristics at 30°C

Sample trip characteristics - KM

	125%	150%	200%	400%	600%	800%	1000%
minimum (sec)	15	8	4	0.7	0.09	0.007	0.005
maximum (sec)	300	90	28	4	1.5	0.6	0.4

Although the 9926 series uses a magnetic only trip mechanism, CSA testing indicates a trip characteristic similar to thermal magnetic trip mechanisms. No de-rating is required at elevated temperatures.

Additional trip curves and amp ratings are available upon request.

9926 Series AC Version - dimensions in mm (in.)

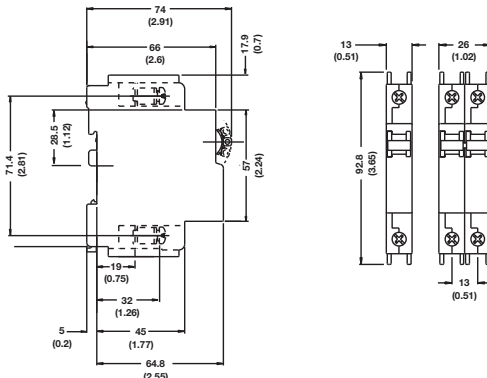

9926 Series—AC version Trip Curve

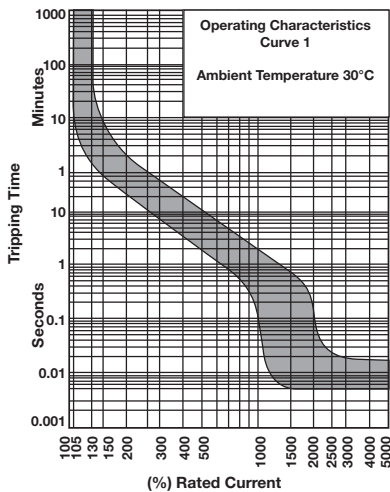

9926 Series—AC version Trip Curve

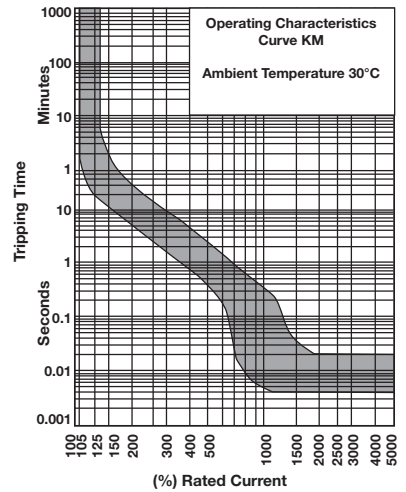

Trip Curve 1 applies to the following part numbers where "XX" is the current rating:
Single Pole— 99262512XX Double Pole— 99262522XX

9926 Series Branch Rated Circuit Breakers-AC Version with Contacts

Circuit Breakers with Auxiliary switch, Trip alarm, Combination of both

- AC voltages (120/240V)
- Single and double pole versions
- cULus listed according to UL489 and C22.2 No. 5.02, CE, VDE
- Factory fitted auxiliary or trip alarm
- Compact 6.5mm width
- Attached to right hand side of circuit breaker

9926 Series Single Pole w/ Auxiliary Contact†



9926 Series Single Pole Trip (Alarm Contact)



9926 Series Single Pole Combination (Auxiliary & Alarm Contact)†



Technical Data	
Voltage	120/240 VAC, 50/60Hz
Current	
minimum	0.5A
maximum	25A
Interrupting capacity	10,000A
Dielectric strength	1500V, 50/60Hz
Insulation resistance	100MΩ
Operating life	10000
	mechanical operations
Operating temperature	-40...+65°C
Wire size*	
0.5-15A:	14AWG min., 10AWG max.
20-25A:	10AWG min.
Torque	20 in.-lb

Approval
cULus listed according to UL489 and C22.2 No. 5.02, CE, VDE

†UL 489 listed
(5A, 250 VAC; 0.5A, 80 VDC Auxiliary; 0.5A, 125 VDC Trip Alarm)

IEC 60947-5-1 Approved
(5A, 250 VAC; 0.5A, 110 VDC Auxiliary; 0.5A, 125 VDC Trip Alarm)

*Wire sizes: gauges specified are the minimum allowable as per CSA and UL standards.

The 9926 circuit breakers do not have provisions for marking tags. A possible solution is to cut the adhesive SchS2 tag rail to length (approximately 20 mm on a single pole unit so the current rating remains visible or approximately 30 mm on a two pole unit). The SchS2 accepts DEK, WS and ESG 8/17 marking tags. The part number for adhesive SchS2 is **1720600000**.

Type: Single Pole Aux (up to 120 VAC)		
Current Ratings (amps)	Part No.	Description
1	9926261001	QL-A-1-13-DM-KM-1
2	9926261002	QL-A-1-13-DM-KM-2
5	9926261005	QL-A-1-13-DM-KM-5
10	9926261010	QL-A-1-13-DM-KM-10
15	9926261015	QL-A-1-13-DM-KM-15
20	9926261020	QL-A-1-13-DM-KM-20
25	9926261025	QL-A-1-13-DM-KM-25

9926 Series Double Pole w/ Auxiliary Contact†



Type: Single Pole Trip (up to 120 VAC)		
Current Ratings (amps)	Part No.	Description
1	9926271001	QL-T-1-13-DM-KM-1
2	9926271002	QL-T-1-13-DM-KM-2
5	9926271005	QL-T-1-13-DM-KM-5
10	9926271010	QL-T-1-13-DM-KM-10
15	9926271015	QL-T-1-13-DM-KM-15
20	9926271020	QL-T-1-13-DM-KM-20
25	9926271025	QL-T-1-13-DM-KM-25

9926 Series Double Pole Trip (Alarm Contact)



Type: Single Pole Combo (up to 120 VAC)		
Current Ratings (amps)	Part No.	Description
1	9926281001	QL-AT-1-13-DM-KM-1
2	9926281002	QL-AT-1-13-DM-KM-2
5	9926281005	QL-AT-1-13-DM-KM-5
10	9926281010	QL-AT-1-13-DM-KM-10
15	9926281015	QL-AT-1-13-DM-KM-15
20	9926281020	QL-AT-1-13-DM-KM-20
25	9926281025	QL-AT-1-13-DM-KM-25

9926 Series Double Pole Combination (Auxiliary & Alarm Contact)†



Type: Double Pole Aux (up to 240 VAC)		
Current Ratings (amps)	Part No.	Description
1	9926262001	QL-A-2-13-DM-KM-1
2	9926262002	QL-A-2-13-DM-KM-2
5	9926262005	QL-A-2-13-DM-KM-5
10	9926262010	QL-A-2-13-DM-KM-10
15	9926262015	QL-A-2-13-DM-KM-15
20	9926262020	QL-A-2-13-DM-KM-20
25	9926262025	QL-A-2-13-DM-KM-25

Type: Double Pole Trip (up to 240 VAC)		
Current Ratings (amps)	Part No.	Description
1	9926272001	QL-T-2-13-DM-KM-1
2	9926272002	QL-T-2-13-DM-KM-2
5	9926272005	QL-T-2-13-DM-KM-5
10	9926272010	QL-T-2-13-DM-KM-10
15	9926272015	QL-T-2-13-DM-KM-15
20	9926272020	QL-T-2-13-DM-KM-20
25	9926272025	QL-T-2-13-DM-KM-25

Type: Double Pole Combo (up to 240 VAC)		
Current Ratings (amps)	Part No.	Description
1	9926282001	QL-AT-2-13-DM-KM-1
2	9926282002	QL-AT-2-13-DM-KM-2
5	9926282005	QL-AT-2-13-DM-KM-5
10	9926282010	QL-AT-2-13-DM-KM-10
15	9926282015	QL-AT-2-13-DM-KM-15
20	9926282020	QL-AT-2-13-DM-KM-20
25	9926282025	QL-AT-2-13-DM-KM-25

9926 Series-AC version Trip Curve

Trip Curves—Hydraulic Magnetic Type Typical time/current characteristics at 30°C

Additional trip curves and amp ratings are available upon request.

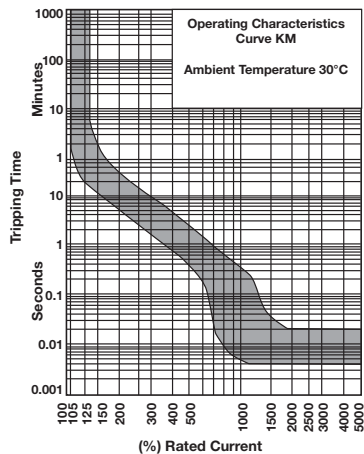

Dual Mount Dimensions in mm (in.)

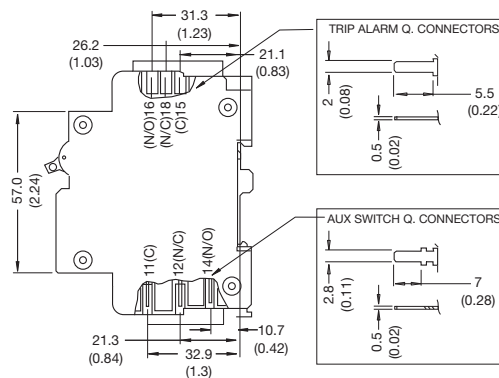

9926 Series Branch Rated Circuit Breakers—DC Version

Circuit Breakers Hydraulic Magnetic Type

- Single pole versions only
- U2 trip curve for general purpose applications
- 80 and 125 VDC
- Up to 60A
- Just 13 mm wide
- Mounts on 35mm DIN-rail
- UL 489A listed
- VDE

9926 Series Single Pole (80 VDC)



9926 Series Single Pole (125 VDC)



Ordering Data

Type: Single Pole (80 VDC)

Current Ratings (amps)	Part No.	Description
0.5	9926251900	QY-1-13-DM-U2-0.5
1	9926251901	QY-1-13-DM-U2-01
2	9926251902	QY-1-13-DM-U2-02
3	9926251903	QY-1-13-DM-U2-03
4	9926251904	QY-1-13-DM-U2-04
5	9926251905	QY-1-13-DM-U2-05
10	9926251910	QY-1-13-DM-U2-10
15	9926251915	QY-1-13-DM-U2-15
20	9926251920	QY-1-13-DM-U2-20
25	9926251925	QY-1-13-DM-U2-25
30	9926251930	QY-1-13-DM-U2-30
35	9926251935	QY-1-13-DM-U2-35
40	9926251940	QY-1-13-DM-U2-40
45	9926251945	QY-1-13-DM-U2-45
50	9926251950	QY-1-13-DM-U2-50
60	9926251960	QY-1-13-DM-U2-60

Type: Single Pole (125 VDC)

Current Ratings (amps)	Part No.	Description
1	9926251801	QY-1-13-DM-U2-01-B1
2	9926251802	QY-1-13-DM-U2-02-B1
3	9926251803	QY-1-13-DM-U2-03-B1
4	9926251804	QY-1-13-DM-U2-04-B1
5	9926251805	QY-1-13-DM-U2-05-B1
10	9926251810	QY-1-13-DM-U2-10-B1
15	9926251815	QY-1-13-DM-U2-15-B1
20	9926251820	QY-1-13-DM-U2-20-B1
25	9926251825	QY-1-13-DM-U2-25-B1
30	9926251830	QY-1-13-DM-U2-30-B1
35	9926251835	QY-1-13-DM-U2-35-B1
40	9926251840	QY-1-13-DM-U2-40-B1
45	9926251845	QY-1-13-DM-U2-45-B1
50	9926251850	QY-1-13-DM-U2-50-B1
60	9926251860	QY-1-13-DM-U2-60-B1

Accessories

Type	Part No.
Bus-bar (1 pole, insulated 1m)	67101904
Bus bar end cap, 1 pole	67101973
Power lug, straight	67101960
Power lug, 90°	67101961
Lock-out handle	67101913

Technical Data

Voltage	80,125 VDC
Current	
minimum	0.5 A
maximum	60 A
Interrupting capacity	10,000 A
Dielectric strength	1500 V, 50/60 Hz
Insulation resistance	100 MΩ
Operating life	10000 mechanical operations
Operating temperature	-40...+65°C
Wire size*	
1-15A:	14 AWG min., 10 AWG max.
20-25A:	10 AWG min.
Torque	20 in.-lb

Approval

UL 489A Listed, CE, VDE

*Wire sizes: gauges specified are the minimum allowable as per CSA and UL standards.

The 9926 circuit breakers do not have provisions for marking tags. A possible solution is to cut the adhesive SchS2 tag rail to length (approximately 20 mm on a single pole unit so the current rating remains visible or approximately 30 mm on a two pole unit). The SchS2 accepts DEK, WS and ESG 8/17 marking tags. The part number for adhesive SchS2 is **1720600000**.

9926 Series—DC version Trip Curve

Trip Curves—Hydraulic Magnetic Type Typical time/current characteristics at 30°C

Additional trip curves and amp ratings are available upon request.

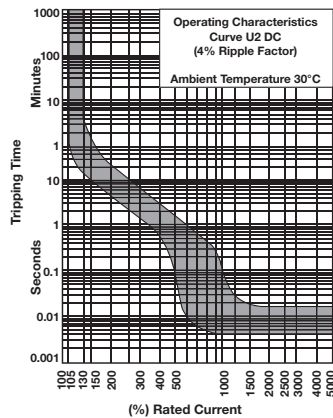

Dimensions in mm (in.)

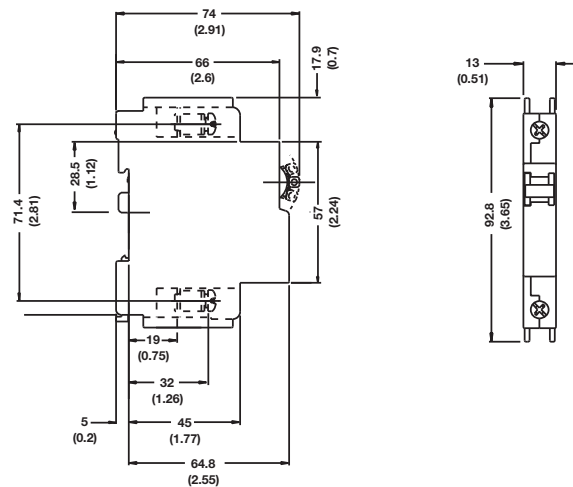

9926 Series Supplemental Circuit Breakers

Circuit Breakers Hydraulic Magnetic Type

- AC Voltages 277/480V
- Trip curve 2 for general purpose applications
- UL 1077 recognized
- VDE approved and CE marked
- Just 13 mm wide
- Mounts to 35 mm DIN-rail
- Factory fitted auxiliary or trip alarm
- Single, double and triple pole versions

9926 Series Single Pole



9926 Series Double Pole



9926 Series Triple Pole



Ordering Data

Type: Single Pole (up to 277 VAC)

Current Ratings (amps)	Part No.	Description
1	9926251501	QZ-1-13-D-2-01
2	9926251502	QZ-1-13-D-2-02
3	9926251503	QZ-1-13-D-2-03
4	9926251504	QZ-1-13-D-2-04
5	9926251505	QZ-1-13-D-2-05
6	9926251506	QZ-1-13-D-2-06
8	9926251508	QZ-1-13-D-2-08
10	9926251510	QZ-1-13-D-2-10
15	9926251515	QZ-1-13-D-2-15
20	9926251520	QZ-1-13-D-2-20
25	9926251525	QZ-1-13-D-2-25
35	9926251535	QZ-1-13-D-2-35
40	9926251540	QZ-1-13-D-2-40
50	9926251550	QZ-1-13-D-2-50
60	9926251560	QZ-1-13-D-2-60

Type: Double Pole (up to 480 VAC)

Current Rating (amps)	Part No.	Description
1	9926252501	QZ-2-13-D-2-01
2	9926252502	QZ-2-13-D-2-02
4	9926252504	QZ-2-13-D-2-04
5	9926252505	QZ-2-13-D-2-05
6	9926252506	QZ-2-13-D-2-06
10	9926252510	QZ-2-13-D-2-10
15	9926252515	QZ-2-13-D-2-15
20	9926252520	QZ-2-13-D-2-20
25	9926252525	QZ-2-13-D-2-25
30	9926252530	QZ-2-13-D-2-30
35	9926252535	QZ-2-13-D-2-35
40	9926252540	QZ-2-13-D-2-40
50	9926252550	QZ-2-13-D-2-50
60	9926252560	QZ-2-13-D-2-60

Type: Triple Pole (up to 480 VAC)

Current Rating (amps)	Part No.	Description
10	9926253510	QZ-3-13-D-2-10
15	9926253515	QZ-3-13-D-2-15
20	9926253520	QZ-3-13-D-2-20
25	9926253525	QZ-3-13-D-2-25
30	9926253530	QZ-3-13-D-2-30
40	9926253540	QZ-3-13-D-2-40
50	9926253550	QZ-3-13-D-2-50
60	9926253560	QZ-3-13-D-2-60

Accessories

Type	Part No.
Bus bar (1 pole, insulated 1m)	67101904
Bus bar (2 pole, insulated 1m)	67101972
Bus bar (3 pole, insulated 1m)	67101971
Bus bar end cap, 1 pole	67101973
Bus bar end cap, 2 pole or 3 pole	67101974
Power lug, straight	67101960
Power lug, 90°	67101961
Lock-out handle	67101913

9926 Series Supplemental – dimensions in mm (in.)

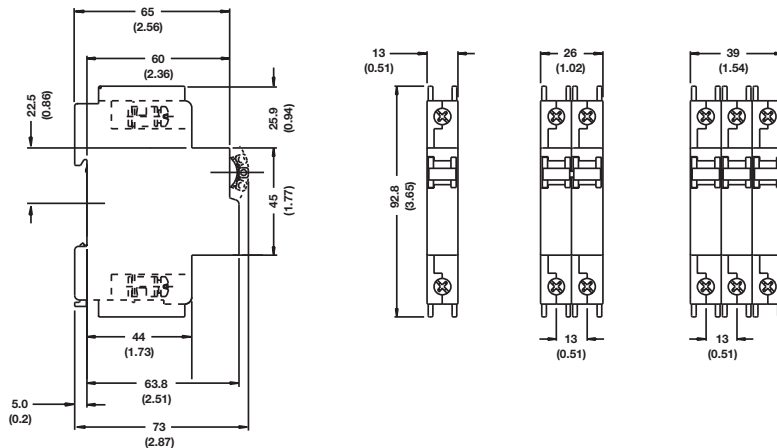

Technical Data

Voltage	277/480 VAC @ 50/60 Hz
Current	
minimum	0.5 A
maximum	60 A
Interrupting capacity	5 kA @ 277/480 V, 5 kA @ 120 V, 5 kA @ 240 V
Dielectric strength	1500 V, 50/60 Hz
Insulation resistance	100 MΩ
Operating life	10000 mechanical operations
Operating temperature	-40...+65°C
Wire size*	
1-15A:	14 AWG min., 10 AWG max.
20-25A:	10 AWG min.
Torque	20 in.-lb

Approval

†UL 1077 Recognized, VDE (EN 60947-2) Approved, CSA C22.2 No. 235, CE Marked

*Wire sizes: gauges specified are the minimum allowable as per CSA and UL standards.

The 9926 circuit breakers do not have provisions for marking tags. A possible solution is to cut the adhesive SchS2 tag rail to length (approximately 20 mm on a single pole unit so the current rating remains visible or approximately 30 mm on a two pole unit). The SchS2 accepts DEK, WS and ESG 8/17 marking tags. The part number for adhesive SchS2 is 172060000.

†cURus recognized to UL1077 and C22.2 No. 235

9926 Series—Supplemental Trip Curve

Trip Curves—Hydraulic Magnetic Type Typical time/current characteristics at 30°C

Additional trip curves and amp ratings are available upon request.

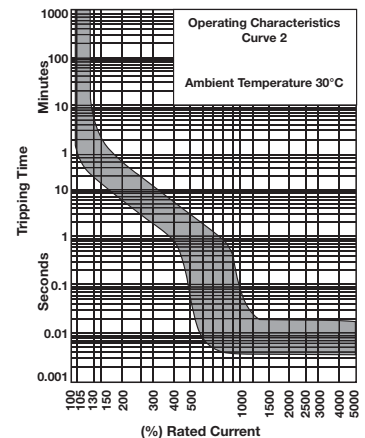

9926 Series Supplemental Circuit Breakers with Contacts

Circuit Breakers Auxiliary switch, Trip alarm, Combination of both

- AC Voltages 277/480V
- Trip curve 2 for general purpose applications
- UL 1077 recognized
- VDE approved and CE marked
- Just 13 mm wide
- Mounts to 35 mm DIN-rail
- Factory fitted auxiliary or trip alarm
- Single, double and triple pole versions

Technical Data	
Voltage	277/480 VAC @ 50/60 Hz
Current	
minimum	0.5 A
maximum	60 A
Interrupting capacity	5 kA @ 277/480 V, 5 kA @ 120 V, 5 kA @ 240 V
Dielectric strength	1500 V, 50/60 Hz
Insulation resistance	100 MΩ
Operating life	10000 mechanical operations
Operating temperature	-40...+65°C
Wire size*	
1-15A:	14 AWG min., 10 AWG max.
20-25A:	10 AWG min.
Torque	20 in.-lb

Approval
 †UL 1077 Recognized, VDE (EN 60947-2)
 Approved, CSA C22.2 No. 235, CE Marked
 ‡UL 489 listed
 (5A, 250 VAC; 0.5A, 80 VDC Auxiliary; 0.5A, 125 VDC Trip Alarm)
 IEC 60947-5-1 Approved
 (5A, 250 VAC; 0.5A, 110 VDC Auxiliary; 0.5A, 125 VDC Trip Alarm)

*Wire sizes: gauges specified are the minimum allowable as per CSA and UL standards.

The 9926 circuit breakers do not have provisions for marking tags. A possible solution is to cut the adhesive SchS2 tag rail to length (approximately 20 mm on a single pole unit so the current rating remains visible or approximately 30 mm on a two pole unit). The SchS2 accepts DEK, WS and ESG 8/17 marking tags. The part number for adhesive SchS2 is **172060000**.

9926 Series—Supplemental Trip Curve

Trip Curves—Hydraulic Magnetic Type Typical time/current characteristics at 30°C

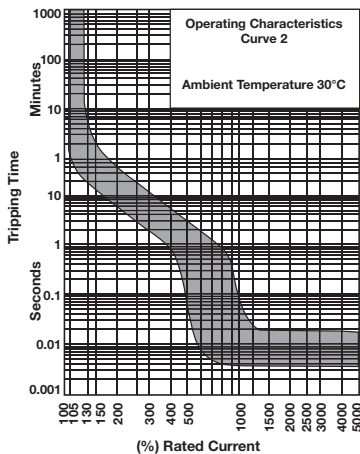

†cURus recognized to UL1077 and C22.2 No. 235

9926 Series Single Pole w/ Auxiliary Contact†



Type: Single Pole Aux (up to 277 VAC)			
Current Ratings (amps)	Part No.	Description	
1	9926261501	QZ-A-1-13-D-2-01	
2	9926261502	QZ-A-1-13-D-2-02	
5	9926261505	QZ-A-1-13-D-2-05	
10	9926261510	QZ-A-1-13-D-2-10	
15	9926261515	QZ-A-1-13-D-2-15	
20	9926261520	QZ-A-1-13-D-2-20	
25	9926261525	QZ-A-1-13-D-2-25	

9926 Series Double Pole w/ Auxiliary Contact†



Type: Double Pole Aux (up to 480 VAC)			
Current Ratings (amps)	Part No.	Description	
1	9926262501	QZ-A-2-13-D-2-01	
2	9926262502	QZ-A-2-13-D-2-02	
5	9926262505	QZ-A-2-13-D-2-05	
10	9926262510	QZ-A-2-13-D-2-10	
15	9926262515	QZ-A-2-13-D-2-15	
20	9926262520	QZ-A-2-13-D-2-20	
25	9926262525	QZ-A-2-13-D-2-25	

9926 Series Triple Pole w/ Auxiliary Contact†



Type: Triple Pole Aux (up to 480 VAC)			
Current Ratings (amps)	Part No.	Description	
1	9926263501	QZ-A-3-13-D-2-01	
2	9926263502	QZ-A-3-13-D-2-02	
5	9926263505	QZ-A-3-13-D-2-05	
10	9926263510	QZ-A-3-13-D-2-10	
15	9926263515	QZ-A-3-13-D-2-15	
20	9926263520	QZ-A-3-13-D-2-20	
25	9926263525	QZ-A-3-13-D-2-25	

9926 Series Single Pole Trip (Alarm Contact)



Type: Single Pole Trip (up to 277 VAC)			
Current Ratings (amps)	Part No.	Description	
1	9926271501	QZ-T-1-13-D-2-01	
2	9926271502	QZ-T-1-13-D-2-02	
5	9926271505	QZ-T-1-13-D-2-05	
10	9926271510	QZ-T-1-13-D-2-10	
15	9926271515	QZ-T-1-13-D-2-15	
20	9926271520	QZ-T-1-13-D-2-20	
25	9926271525	QZ-T-1-13-D-2-25	

9926 Series Double Pole Trip (Alarm Contact)



Type: Double Pole Trip (up to 480 VAC)			
Current Ratings (amps)	Part No.	Description	
1	9926272501	QZ-T-2-13-D-2-01	
2	9926272502	QZ-T-2-13-D-2-02	
5	9926272505	QZ-T-2-13-D-2-05	
10	9926272510	QZ-T-2-13-D-2-10	
15	9926272515	QZ-T-2-13-D-2-15	
20	9926272520	QZ-T-2-13-D-2-20	
25	9926272525	QZ-T-2-13-D-2-25	

9926 Series Triple Pole Trip (Alarm Contact)



Type: Triple Pole Trip (up to 480 VAC)			
Current Ratings (amps)	Part No.	Description	
1	9926273501	QZ-T-3-13-D-2-01	
2	9926273502	QZ-T-3-13-D-2-02	
5	9926273505	QZ-T-3-13-D-2-05	
10	9926273510	QZ-T-3-13-D-2-10	
15	9926273515	QZ-T-3-13-D-2-15	
20	9926273520	QZ-T-3-13-D-2-20	
25	9926273525	QZ-T-3-13-D-2-25	

9926 Series Single Pole Combination (Auxiliary & Alarm Contact)†



Type: Single Pole Combo (up to 277 VAC)			
Current Ratings (amps)	Part No.	Description	
1	9926281501	QZ-AT-1-13-D-2-01	
2	9926281502	QZ-AT-1-13-D-2-02	
5	9926281505	QZ-AT-1-13-D-2-05	
10	9926281510	QZ-AT-1-13-D-2-10	
15	9926281515	QZ-AT-1-13-D-2-15	
20	9926281520	QZ-AT-1-13-D-2-20	
25	9926281525	QZ-AT-1-13-D-2-25	

9926 Series Double Pole Combination (Auxiliary & Alarm Contact)†



Type: Double Pole Combo (up to 480 VAC)			
Current Ratings (amps)	Part No.	Description	
1	9926282501	QZ-AT-2-13-D-2-01	
2	9926282502	QZ-AT-2-13-D-2-02	
5	9926282505	QZ-AT-2-13-D-2-05	
10	9926282510	QZ-AT-2-13-D-2-10	
15	9926282515	QZ-AT-2-13-D-2-15	
20	9926282520	QZ-AT-2-13-D-2-20	
25	9926282525	QZ-AT-2-13-D-2-25	

9926 Series Triple Pole Combination (Auxiliary & Alarm Contact)†



Type: Triple Pole Combo (up to 480 VAC)			
Current Ratings (amps)	Part No.	Description	
1	9926283501	QZ-AT-3-13-D-2-01	
2	9926283502	QZ-AT-3-13-D-2-02	
5	9926283505	QZ-AT-3-13-D-2-05	
10	9926283510	QZ-AT-3-13-D-2-10	
15	9926283515	QZ-AT-3-13-D-2-15	
20	9926283520	QZ-AT-3-13-D-2-20	
25	9926283525	QZ-AT-3-13-D-2-25	

9926 Series Supplemental Circuit Breakers–GFCI

Ground Fault Current Interrupt

- CE approved
- UL1077 and UL1053 recognized
- Small frame size (26mm wide)
- Single pole plus switched neutral ground leakage protection
- Trip point is unaffected by ambient temperature
- Current ratings up to 50A
- Trip indication (mid trip handle position)
- Trip curve 2 for general purpose applications

9926 Series GFCI



Ordering Data

Technical Data

Standard Ampere Ratings (A)	5 to 50A
Sensitivity (mA)	30 (CE) / 22 (UL)
Number of Poles	1 + N
Equipment Type	Ground Leakage/GFCS
Rated Voltage (V)	230 (CE) / 240 (UL)
Rated Interrupting/Withstand Capacity (kA)	5 kA
Weight (kg)	0.26
Trip Curve (standard)	2
Operating Temperature	-40 to +65°C

Approval

UL 1077 and UL 1053, CE

Type: Single Pole GFCI

Current Ratings

(amps)	Part No.	Description
5	9926291105	QF17A2505 - CB W/GFI
10	9926291110	QF17A2510 - CB W/GFI
15	9926291115	QF17A2515 - CB W/GFI
20	9926291120	QF17A2520 - CB W/GFI
25	9926291125	QF17A2525 - CB W/GFI
30	9926291130	QF17A2530 - CB W/GFI
50	9926291150	QF17A2550 - CB W/GFI

9926 Series–AC version Trip Curve

Trip Curves—Hydraulic Magnetic Type Typical time/current characteristics at 30°C

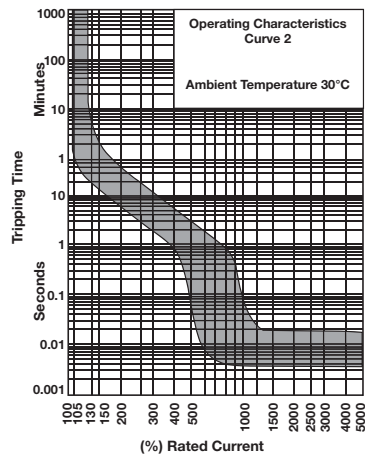

9926 Series GFCI – dimensions in mm (in.)

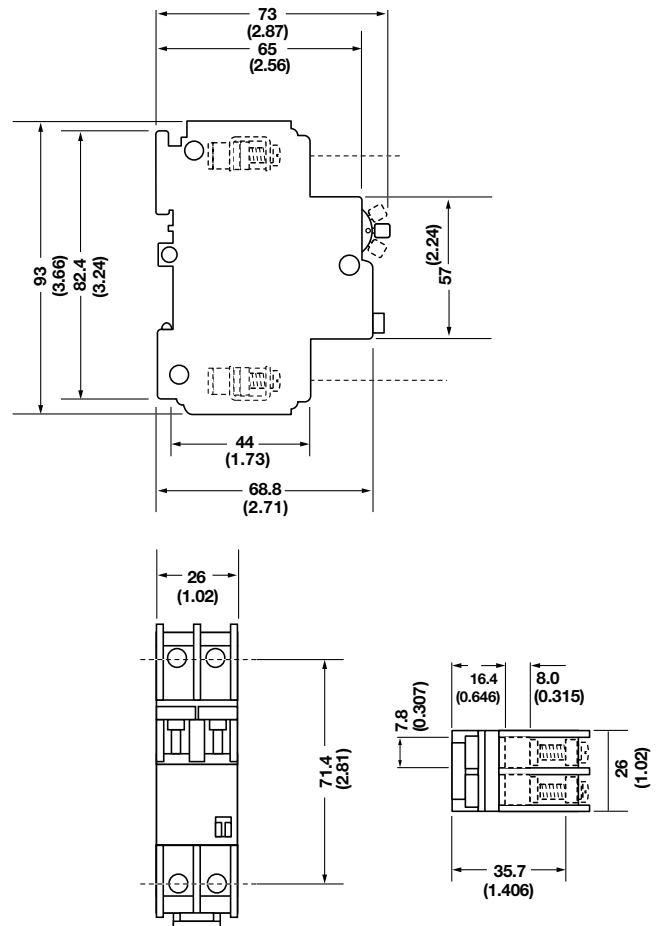

9926 Series Mounting Options and Accessories

Mounting Options

If the product is not vertically mounted in the normal DIN-rail mounting orientation, a rating factor must be applied. Figure 1 shows a diagram of the rating factor to apply. The published curves for these circuit breaker products are produced with the circuit breaker in the vertical mounting position. The rating factor only applies to the must hold and must trip points of the curve as the other parts (instantaneous trip point) stay largely unaffected.

It is important to note that in environments that are exposed to a high degree of vibration, the cables that connect to the circuit breaker must be securely held in place, as the breaker is not designed to carry the weight of the cables. A maximum of 35N can be applied to the terminal area, in a direction perpendicular to the mounting axis.

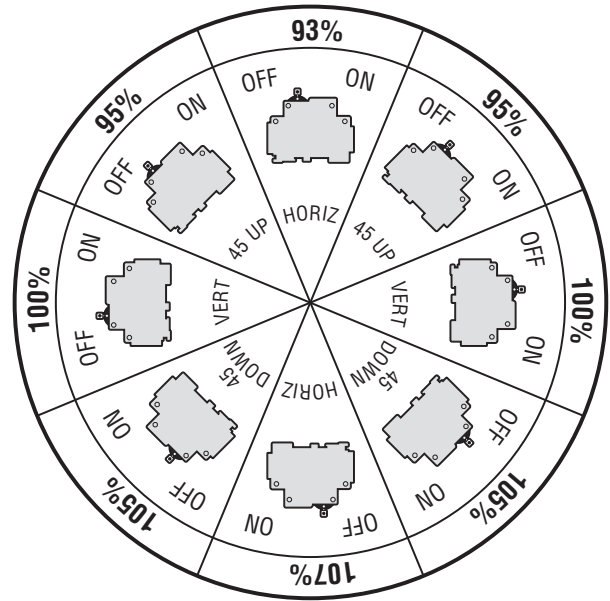

Accessories

Technical Data	
Current Rating	80A max.
Voltage	500V max.
Short Circuit Strength	25kA

Type	Part No.
Bus bar (1 pole, insulated 1m)	67101904
Bus bar (2 pole, insulated 1m)	67101972
Bus bar (3 pole, insulated 1m)	67101971

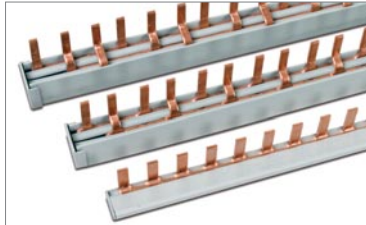

Type	Part No.
Bus bar end cap, 1 pole	67101973
Bus bar end cap, 2 pole or 3 pole	67101974



Technical Data	
Current Rating	85A max.
Wire Size	10 AWG min., 4 AWG max.
Dimensions	A: 6 mm B: 32 mm

Type	Part No.
Power lug, straight	67101960
Power lug, 90°	67101961



Type	Part No.
Lock-out handle	67101913

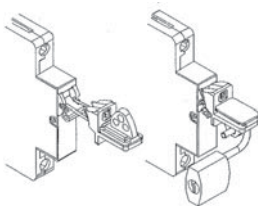

Part Number Table - Example

To order 9926 Series Single Pole Circuit Breaker
Part No. 9926251000

- Current Rating of 1.0 amp
- Internal Resistance per Pole of 1.1 ohms
- Trip Curve – M1, Medium (Standard)

9 9 2 6 2 5 1 0 0 0

Amperage

- *00* - 0.5A
- *01* - 1A
- *02* - 2A
- *60* - 60A

Trip Curves (Types 5-9)

- *0* - Branch AC KM (Standard)
- *1* - Branch AC OP (Instantaneous)
- *2* - Branch AC 1 (Fast)
- *3* - Supplemental 9 (Slow)
- *4* - Branch 80VDC 1 (Fast)
- *5* - Supplemental 2 (Standard)
- *6* - Branch 125VDC OP (Instantaneous)
- *7* - Branch 80VDC OP (Instantaneous)
- *8* - Branch 125VDC U2 (Standard)
- *9* - Branch 80VDC U2 (Standard)

Poles

- 1 Pole
- 2 Pole
- 3 Pole

Type

- *5* - Base Breaker
- *6* - With Auxiliary Contact
- *7* - With Trip Alarm Contact
- *8* - Combo Aux/Trip Contact
- *9* - GFCI

9 9 2 6 2 4 1 0 0 0

Amperage

- *00* - 0.5A
- *01* - 1A
- *02* - 2A
- *60* - 60A

Trip Curves (Type 4)

- *0* - Supplemental 1 (Slow)
- *1* - Supplemental 3 (Fast)
- *3* - Branch AC 9 (Slow)

Poles

- 1 Pole
- 2 Pole
- 3 Pole

Type

- *4* - Base Breaker

CB4200 Series Supplemental Circuit Breakers

Circuit Breakers Thermal Magnetic Type

- Rated from 0.05 to 16.0 amps
- Available in single or double pole configurations
- Features a tease free design to reduce contact damage
- Offers push button trip/reset function
- Trip free design means the breaker cannot be held closed against a fault
- Mounts on 32mm* or 35mm DIN-rail
- UL 1077 recognized
- CSA C22.2 No. 235

CB4200 Series Single Pole



CB4200 Series Double Pole



Ordering Data	Type: Single Pole		Type: Double Pole	
	Current Ratings (amps)	Part No. TS 35 *For TS 32 Rail, see adapter below	Current Ratings (amps)	Part No. TS 35 *For TS 32 Rail, see adapter below
	0.05	9124083500	0.05	9124223500
	0.08	9124653500	0.08	9124233500
	0.1	9104173500	0.1	9120353500
	0.2	9104183500	0.2	9124243500
	0.3	9129813500	0.3	9124263500
	0.4	9124093500	0.4	9124273500
	0.5	9101003500	0.5	9129583500
	0.6	9124113500	0.6	9124283500
	0.7	9129563500	0.7	9124293500
	0.8	9101103500	0.8	9129593500
	1.0	9101203500	1.0	9129613500
	1.2	9101303500	1.2	9129623500
	1.3	9124123500	1.3	9124313500
	1.4	9124133500	1.4	9124323500
	1.5	9101403500	1.5	9129633500
	1.8	9124143500	1.8	9124333500
	2.0	9101503500	2.0	9129643500
	2.5	9101603500	2.5	9129653500
	3.0	9101703500	3.0	9129663500
	3.5	9124163500	3.5	9124343500
	4.0	9104353500	4.0	9129713500
	4.5	9124173500	4.5	9124353500
	5.0	9101803500	5.0	9129673500
	5.5	9107833500	5.5	9124363500
	6.0	9103813500	6.0	9124373500
	6.5	9120043500	6.5	9124383500
	7.0	9104153500	7.0	9124393500
	8.0	9103003500	8.0	9104673500
	9.0	9104613500	9.0	9124423500
	10.0	9101903500	10.0	9129683500
	11.0	9124183500	11.0	9124433500
	12.0	9107843500	12.0	9124443500
	13.0	9124193500	13.0	9124453500
	14.0	9107853500	14.0	9124463500
	15.0	9102003500	15.0	9129693500
	16.0	9124213500	16.0	9124473500

Trip Curves Thermal Magnetic Type Typical time/current characteristics at 23°C

CB4200 Series

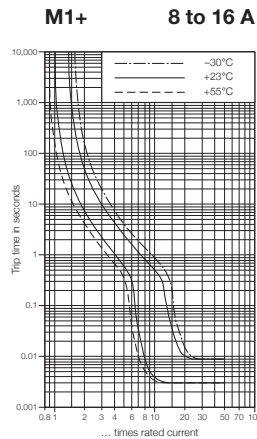
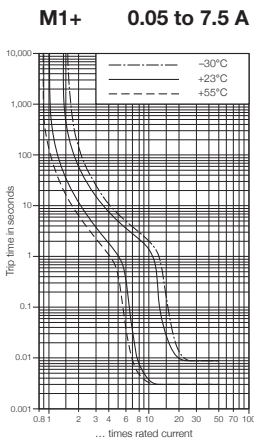

*Adapter foot – dimensions in mm (in.)

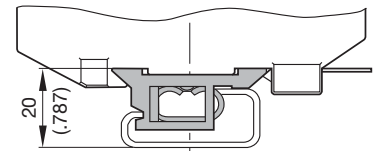

9102100000
TS32 adapter

CB4200 Series Supplemental Circuit Breakers

CB4200 Series Single Pole

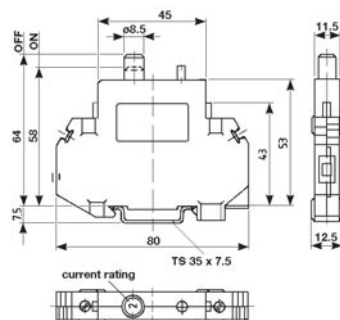

Internal Wiring Diagram

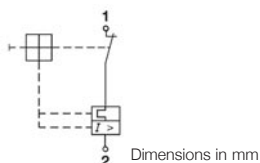

CB4200 Series Double Pole

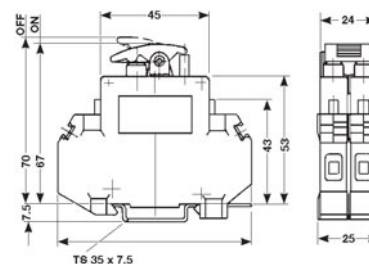

Internal Wiring Diagram

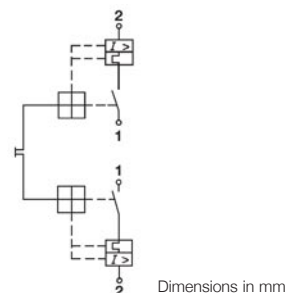

Technical Data

Rated voltage & current†	UL
	CSA
	VDE
Creepage resistance	
Dielectric strength	
Insulation resistance	
Interrupting capacity (VDE 0660, Part 101, P-2)	
Interrupting capacity; 4201 (UL 1077/EN 60934 PC1)	
Typical life at 2 x rated current	
Shock	
Torque	
Vibration	
Temperature range	
Corrosion	
Humidity	
Weight	
Wire size (UL)	

Voltage Ratings		Current Ratings
AC 250 V, DC 65 V, 50/60 Hz		0.05...16 A
AC 250 V, DC 65 V, 50/60 Hz		0.05...16 A
AC 250 V, DC 65 V, 50/60 Hz		0.05...16 A
PTI 600 to IEC 112		
4,000 VAC; IEC 664 & 664 A		
> 100 MΩ (DC 500 V)		
4201-10	Maximum capacity	
0.05...0.8 A	Self-limiting	
1...2 A	200 A	
2.5...16 A	400 A	
Rated current	Rated voltage	Maximum capacity
0.05...2.0 A	AC 250 V	200 A
2.0...16 A	AC 250 V	200 A
20 A	AC 125 V	400 A

5,000 operations
25 g (11 ms) to IEC 68-2-27, Test Ea
1.2 Nm
5 g (57 to 500 Hz / ±0.38 mm, 10 to 57 Hz) to IEC 68-2-6, Test Fc
-30°C...+55°C (-22°F...+131°F)
96 hours at 5% salt spray, to IEC 68-2-11, Test Ka
240 hours at 95% RH, to IEC 68-2-3, Test Ca
60 g per pole
#20...8 AWG solid/0.5...6 mm ²

Accessories

Jumpers	
	Daisy Chain 50*
	Straight CQB** insulated
	Angled CQB** insulated
Adapter foot (for TS 32 Rail)	
Busbar	Single pole 1 meter
Busbar end cap for 6720000227	
Power lug for 6720000227	

Type	Part No.
BDC 50	9970290000
CQB 2	9970560000
CQB 3	9970570000
CQB 4	9970580000
CQB 10	9970590000
CQB 2	9970600000
CQB 3	9970610000
CQB 4	9970620000
CQB 10	9970630000
MCBAF/TS 32	9102100000
	6720000227
	6720000225
	6720000226

Marking Tags

Note: Part numbers are shown for a single card of pre-printed tags numbered 1-50.	Special print only
	Consecutive horizontal
	Consecutive vertical

WS 8/5 MC	1640750000***
DEK 5/5	0473460001
DEK 5/5	0473560001

†Note: Resistive and inductive loads (0.05 - 16 A)

*BDC will accommodate 20 A per pin, 20 A total

**CQB will accommodate 18 A per pin, 18 A total; dedicated to 4201 Series

***Please specify horizontal or vertical print when ordering.

Standard quantity = 144 tags per card.

CB2200 Series Supplemental Circuit Breakers

Circuit Breakers Thermal Magnetic Type

- Rated from 0.1 to 32.0 amps
- Available in single, double and triple pole configurations
- Offers normally open (N/O) and normally closed (N/C) auxiliary contacts
- Lever-switch trip/reset function
- Mounts on 32mm or 35mm DIN-rail
- UL 1077 recognized
- CSA C22.2 No. 235

CB2200 Series Single Pole



CB2200 Series Double Pole



CB2200 Series Triple Pole



Ordering Data	Type: Single Pole*		Type: Double Pole		Type: Triple Pole	
	Current Ratings (amps)	N/O Aux. Part No.	Current Ratings (amps)	N/O-N/C Part No.	Current Ratings (amps)	N/O-N/C Part No.
	0.1	9911010005	0.1	9912010003	0.1	9913010003
	0.2	9911020005	0.2	9912020003	0.2	9913020003
	0.3	9911030005	0.3	9912030003	0.3	9913030003
	0.4	9911040005	0.4	9912040003	0.4	9913040003
	0.5	9911050005	0.5	9912050003	0.5	9913050003
	0.6	9911060005	0.6	9912060003	0.6	9913060003
	0.8	9911080005	0.8	9912080003	0.8	9913080003
	1.0	9911100005	1.0	9912100003	1.0	9913100003
	1.5	9911150005	1.5	9912150003	1.5	9913150003
	2.0	9911200005	2.0	9912200003	2.0	9913200003
	2.5	9911250005	2.5	9912250003	2.5	9913250003
	3.0	9911300005	3.0	9912300003	3.0	9913300003
	4.0	9911400005	4.0	9912400003	4.0	9913400003
	5.0	9911500005	5.0	9912500003	5.0	9913500003
	6.0	9911600005	6.0	9912600003	6.0	9913600003
	8.0	9911800005	8.0	9912800003	8.0	9913800003
	10	9921100005	10	9922100003	10	9923100003
	12	9921120005	12	9922120003	12	9923120003
	15	9921150005	15	9922150003	15	9923150003
	16	9921160005	16	9922160003	16	9923160003
	18	9921180005	18	9922180003	18	9923180003
	20	9921200005	20	9922200003	20	9923200003
	25	9921250005				
	32	9921320005				

*All part numbers with N/O Auxiliary Contacts on each pole when the main breaker contact is open (in the OFF position)

Ordering Data	Type: Single Pole		Type: Double Pole		Type: Triple Pole	
	All part numbers with N/C Auxiliary Contacts on each pole when the main breaker contact is open (in the OFF position)					
	Current Ratings (amps)	Part No.	Current Ratings (amps)	Part No.	Current Ratings (amps)	Part No.
	0.1	9911010000	0.1	9912010000	0.1	9913010000
	0.2	9911020000	0.2	9912020000	0.2	9913020000
	0.3	9911030000	0.3	9912030000	0.3	9913030000
	0.4	9911040000	0.4	9912040000	0.4	9913040000
	0.5	9911050000	0.5	9912050000	0.5	9913050000
	0.6	9911060000	0.6	9912060000	0.6	9913060000
	0.8	9911080000	0.8	9912080000	0.8	9913080000
	1.0	9911100000	1.0	9912100000	1.0	9913100000
	1.5	9911150000	1.5	9912150000	1.5	9913150000
	2.0	9911200000	2.0	9912200000	2.0	9913200000
	2.5	9911250000	2.5	9912250000	2.5	9913250000
	3.0	9911300000	3.0	9912300000	3.0	9913300000
	4.0	9911400000	4.0	9912400000	4.0	9913400000
	5.0	9911500000	5.0	9912500000	5.0	9913500000
	6.0	9911600000	6.0	9912600000	6.0	9913600000
	8.0	9911800000	8.0	9912800000	8.0	9913800000
	10	9921100000	10	9922100000	10	9923100000
	12	9921120000	12	9922120000	12	9923120000
	15	9921150000	15	9922150000	15	9923150000
	16	9921160000	16	9922160000	16	9923160000
	18	9921180000	18	9922180000	18	9923180000
	20	9921200000	20	9922200000	20	9923200000
	25	9921250000	25	9922250000	25	9923250000
	32	9921320000	32	9922320000	32	9923320000

CB2200 Series Supplemental Circuit Breakers

CB2200 Series

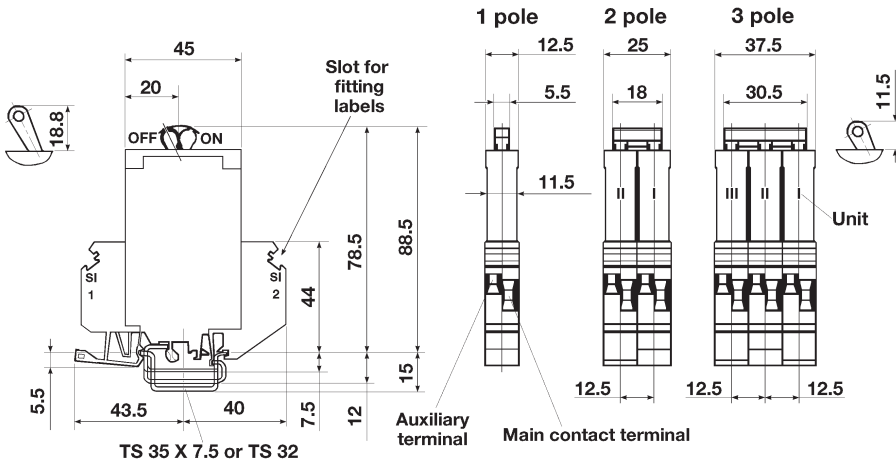

Dimensions in mm

Technical Data

Rated voltage & current†

UL
CSA
VDE

Auxiliary contacts

Creepage resistance

Dielectric strength

Insulation resistance

Interrupting capacity

(VDE 0660, Part 101, P-2)

Interrupting capacity

(UL 1077/EN 60934 PC1)

Typical life at 2 x rated current

Shock

Torque

Nm (lb. in.)

Vibration

Temperature range

Corrosion

Humidity

Weight

Wire size (UL)

Voltage Ratings

277 / 480 VAC (50/60 Hz); 65 VDC

250 / 415 VAC / 65 VDC

250 VAC / 65 VDC, 1 A

PTI 600 to IEC 112

3,000 VAC; IEC 664 & 664 A

> 100 MΩ (DC 500 V)

Rated current

0.05...0.8 A

6...32 A

250 / 415 VAC

400 A

800 A

Rated current

0.1...16 A

20...32 A

0.1...32 A

277 / 480 VAC

5000 A

2000 A

2000 A

65 VDC

Max. rupture capacity (3 times)

5,000 operations

25 g (11 ms) to IEC 68-2-27, Test Ea

0.6 (5.3) Auxiliary contact: 0.5 (4.4)

5 g (57 to 500 Hz / ±0.38 mm, 10 to 57 Hz) to IEC 68-2-6, Test Fc

-30...+60°C (-22°F...+140°F)

96 hours at 5% salt spray, to IEC 68-2-11, Test Ka

240 hours at 95% RH, to IEC 68-2-3, Test Ca

Approximately 60 g per pole

max 6 mm²...8 AWG max 1.5 mm²...14 AWG (Aux. contact)

DEK 5/6

DEK 5/6

DEK 5/6

0490360000*

0468660001

0468760001

Marking Tags

1	2	3	4	5	6
---	---	---	---	---	---

Special print only

Consecutive horizontal

Consecutive vertical

Note: Part numbers shown are for a single card of pre-printed tags numbered 1-50.

†Note: Resistive and inductive loads (0.05 - 16 A)

*Please specify horizontal or vertical print when ordering.

Trip Curves—Thermal Magnetic Type Typical time/current characteristics at 23°C

CB2200 Series

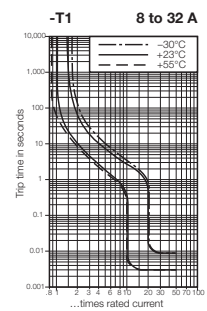
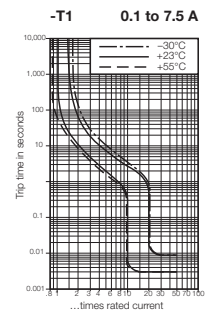
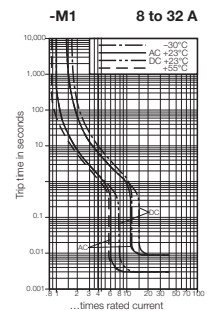
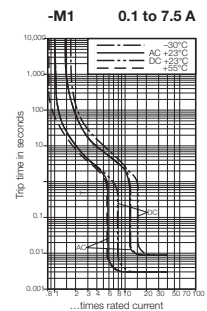
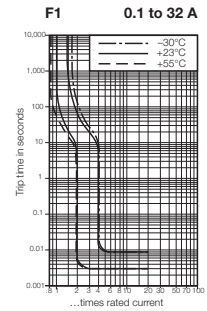

CB9100 Series Supplemental Circuit Breakers

Circuit Breakers Thermal Magnetic Type

- Rated from 0.5 to 63 amps
- Available in single, double and triple pole configurations
- Optional auxiliary contacts
- Mounts on 35mm DIN-rail
- UL and CSA approvals
- CSA 277 VAC (1 pole) or 480 VAC (2 and 3 pole)
- 50 VDC (0.5 A to 50 A) 1 pole
- 110 VDC (0.5 A to 50 A) 2 pole

CB9100 Series Single Pole



CB9100 Series Double Pole



CB9100 Series Triple Pole



Ordering Data	Type: Single Pole		Type: Double Pole		Type: Triple Pole	
	Current Ratings (amps)	Part No.	Current Ratings (amps)	Part No.	Current Ratings (amps)	Part No.
	0.5	9925350000	0.5	9925650000	0.5	9925810000
	1.0	9925360000	1.0	9925660000	1.0	9925820000
	2.0	9925380000	2.0	9925680000	2.0	9925840000
	3.0	9925390000	3.0	9925690000	3.0	9925850000
	4.0	9925400000	4.0	9925700000	4.0	9925860000
	6.0	9925410000	6.0	9925710000	6.0	9925870000
	10.0	9925430000	10.0	9925730000	10.0	9925890000
	13.0	9929820000	13.0	9929830000	13.0	9929840000
	16	9925440000	16	9925740000	16	9925900000
	20	9925450000	20	9925750000	20	9925910000
	25	9925460000	25	9925760000	25	9925920000
	32	9925470000	32	9925770000	32	9925930000
	40	9925480000	40	9925780000	40	9925940000
	50	9925490000	50	9925790000	50	9925950000
	63	9925500000	63	9925800000	63	9925960000

Trip Curves Thermal Magnetic Type Typical time/current characteristics at 23°C

CB9100 Series

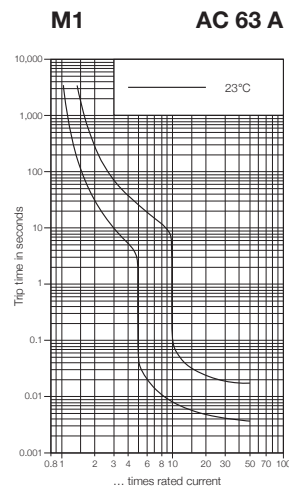
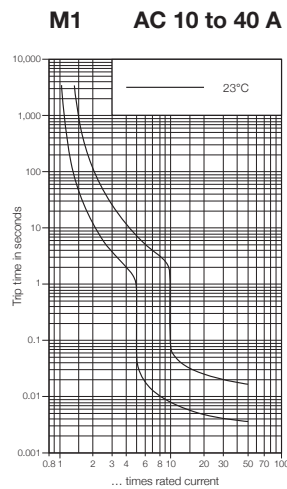
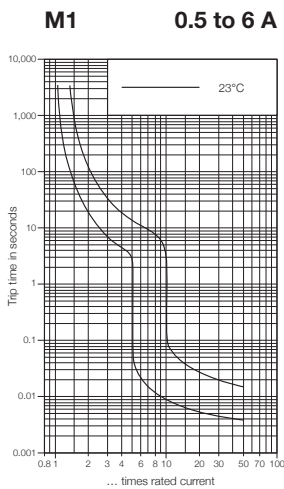

CB9100 Series Supplemental Circuit Breakers

CB9100 Series

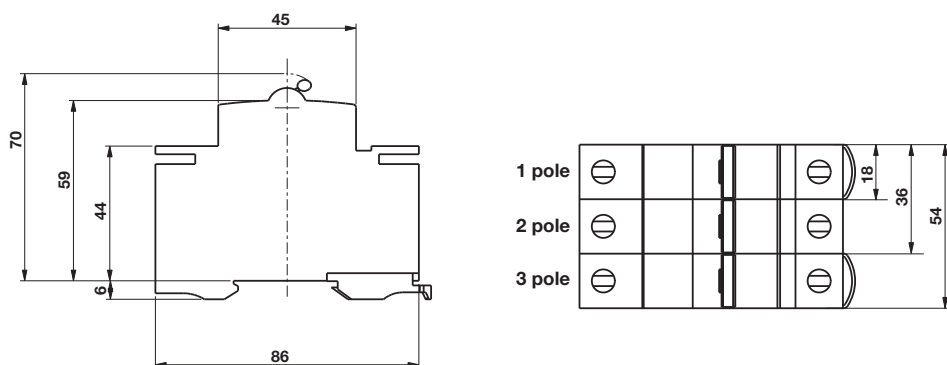

Dimensions in mm

Internal Wiring Diagram

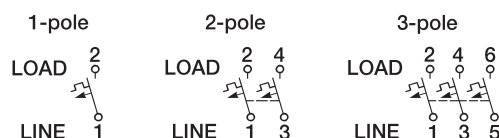

Technical Data

Rated voltage & current

UL 1077	277 V (1 pole)	480 V (2 and 3 pole)	50 VDC (1 pole)	110 VDC (2 pole)
CSA C 22.2 No. 235	277 V (1 pole)	480 V (2 and 3 pole)	50 VDC (1 pole)	110 VDC (2 pole)
VDE				

Creepage resistance

PTI 250 to IEC 112

Insulation resistance

>100 MΩ at 500 VDC

Interrupting capacity

Current ratings	Interrupting Rupture capacity (3X)	Voltage
0.5...63 A	10,000 A (UL)	277 VAC/50 VDC
0.5...32 A	2,000 A (UL)	277 / 480 AC
0.5...63 A	6,000 A (UL)	50 VDC (1) pole
0.5...50 A	6,000 A (UL)	110 VDC (2) poles

(UL 1077/EN 609334 PC1) 1 pole

Mechanical/Electrical endurance

20,000/10,000

Shock

20 g (10 ms)

Torque

2 Nm

Vibration

3 g (10 to 55 Hz)

Temperature range - operating

-25°C...+55°C (-13°F to 131°F)

Weight

1 pole (130 g); 2 pole (280 g); 3 pole (430 g)

Strip length

12 mm

Auxiliary contact rating

Voltage	Current
AC 220/240	5 A
AC 277	3 A
DC 24 V	4 A
DC 60 V	1 A
DC220 V	0.4 A

Wire size - #22...12 AWG

Wire size

#18...2 AWG (line); #18...3 AWG (load)

Auxiliary Contact Modules

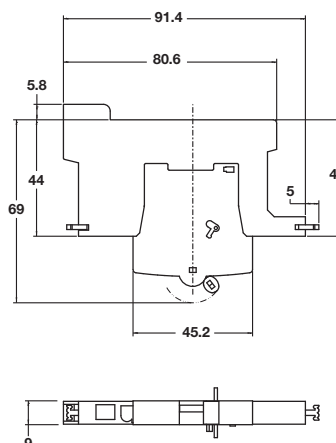

Internal Auxiliary Wiring Diagram

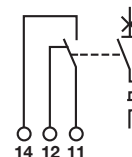

Accessories

Jumpers

Type	Current Side/Middle	Part No.
3 pole bus, 10 x 1010 mm, buses (19) 3 phase groupings	80A/100A	9970330000
3 pole bus, 16 x 210 mm, buses (4) 3 phase groupings	120A/130A	9970340000
3 pole bus, 16 x 1010 mm, buses (19) 3 phase groupings	120A/130A	9970350000
1 pole bus, 12 x 210 mm, buses 12 breakers	80A/100A	9970360000
1 pole bus, 12 x 210 mm (insulated), buses 12 breakers	63A	9991990000
Bus bar clamp	130A	9970370000

Auxiliary contacts

SPDT

Auxiliary contacts

9970300000

Security hardware

Lock out cover

9970380000

Marking Tags

Adhesive label

ETO 10/26, yellow (26 mm x 10 mm)

1686401687