



Chipsmall Limited consists of a professional team with an average of over 10 year of expertise in the distribution of electronic components. Based in Hongkong, we have already established firm and mutual-benefit business relationships with customers from,Europe,America and south Asia,supplying obsolete and hard-to-find components to meet their specific needs.

With the principle of "Quality Parts,Customers Priority,Honest Operation,and Considerate Service",our business mainly focus on the distribution of electronic components. Line cards we deal with include Microchip,ALPS,ROHM,Xilinx,Pulse,ON,Everlight and Freescale. Main products comprise IC,Modules,Potentiometer,IC Socket,Relay,Connector.Our parts cover such applications as commercial,industrial, and automotives areas.

We are looking forward to setting up business relationship with you and hope to provide you with the best service and solution. Let us make a better world for our industry!



Contact us

Tel: +86-755-8981 8866 Fax: +86-755-8427 6832

Email & Skype: info@chipsmall.com Web: www.chipsmall.com

Address: A1208, Overseas Decoration Building, #122 Zhenhua RD., Futian, Shenzhen, China



Four Output Low Power Differential Fanout Buffer for PCI Express Gen1, Gen2, Gen3, and QPI

9DBL411B

General Description:

The ICS9DBL411B is a 4 output lower power differential buffer. Each output has its own OE# pin. It has a maximum operating frequency of 150 MHz.

Recommended Application:

PCI-Express Gen 1/2/3 or QPI fanout buffer

Output Features:

- 4 - low power differential output pairs
- Individual OE# control of each output pair

Key Specifications:

- Output cycle-cycle jitter < 15ps additive
- Output to output skew: < 50ps

Power Groups

Pin Number (TSSOP)		Description
VDD	GND	
9,18	10,17	VDD_IO for DIF(3:0)
4	5	3.3V Analog VDD & GND

Pin Number (MLF)		Description
VDD	GND	
6,15	7,14	VDD_IO for DIF(3:0)
1	2	3.3V Analog VDD & GND

Functional Block Diagram

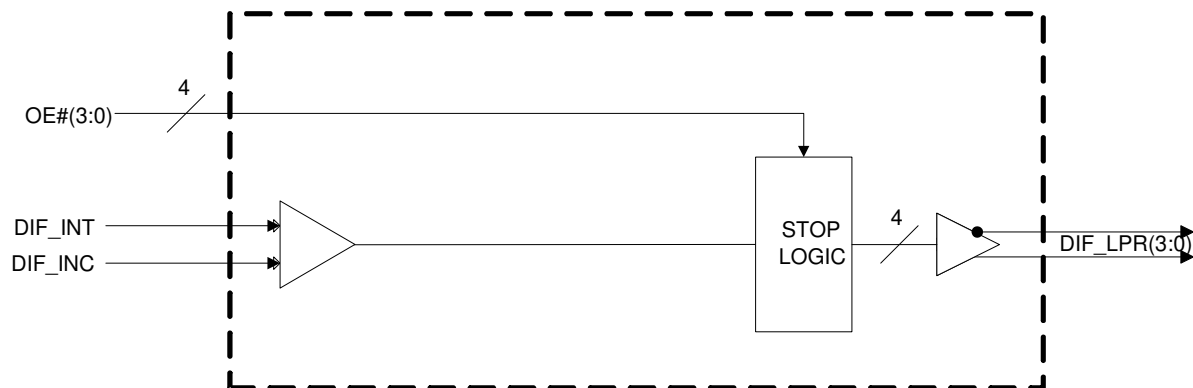

Pin Configurations

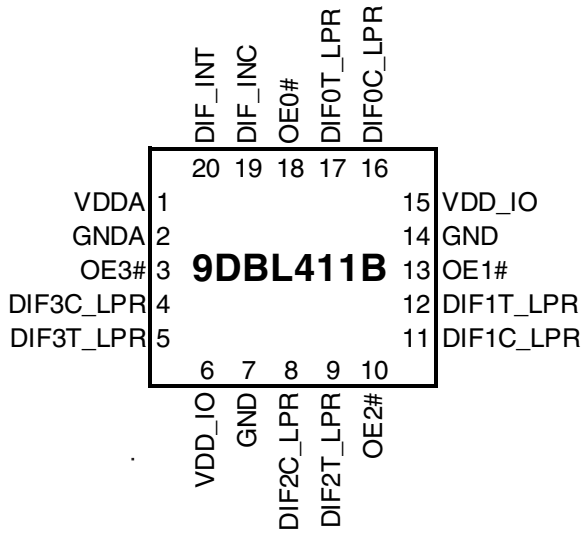

20-pin MLF

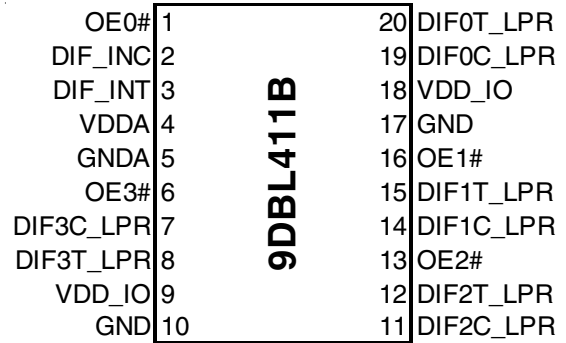

20-pin TSSOP

Terminations

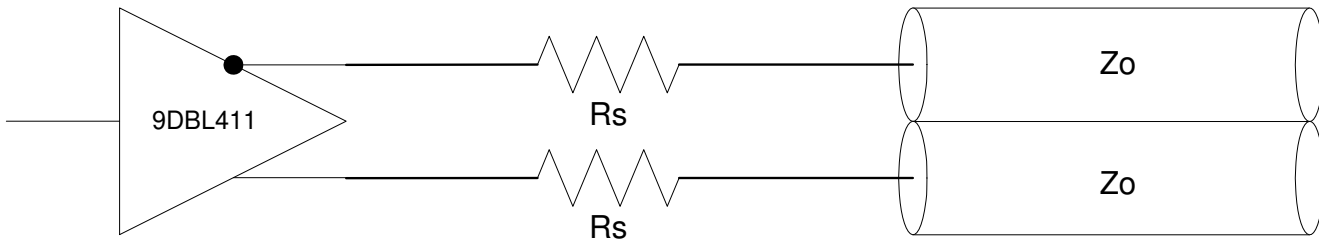

$Z_o - 17 = R_s$ (ohms), where Z_o is the single-ended intrinsic impedance of the board transmission line. Single-ended intrinsic impedance is $\frac{1}{2}$ that of the differential impedance.

Single Ended Impedance (Z_o)	R_s 5% tolerance	R_s 2% tolerance	Notes
50	33	33.2	In general, 5% resistors may be used. All values are in ohms.
45	27	27.4	
42.5	24 or 27	24.9	

TSSOP Pin Description

PIN # (TSSOP)	PIN NAME	PIN TYPE	DESCRIPTION
1	OE0#	IN	Output Enable for DIF0 output. Control is as follows: 0 = enabled, 1 = Low-Low
2	DIF_INC	IN	Complement side of differential input clock
3	DIF_INT	IN	True side of differential input clock
4	VDDA	PWR	3.3V Power for the Analog Core
5	GNDA	GND	Ground for the Analog Core
6	OE3#	IN	Output Enable for DIF3 output. Control is as follows: 0 = enabled, 1 = Low-Low
7	DIF3C_LPR	OUT	Complement clock of low power differential clock pair. (no 50ohm shunt resistor to GND needed)
8	DIF3T_LPR	OUT	True clock of low power differential clock pair. (no 50ohm shunt resistor to GND needed)
9	VDD_IO	PWR	Power supply for low power differential outputs, nominal 1.05V to 3.3V
10	GND	GND	Ground pin
11	DIF2C_LPR	OUT	Complement clock of low power differential clock pair. (no 50ohm shunt resistor to GND needed)
12	DIF2T_LPR	OUT	True clock of low power differential clock pair. (no 50ohm shunt resistor to GND needed)
13	OE2#	IN	Output Enable for DIF2 output. Control is as follows: 0 = enabled, 1 = Low-Low
14	DIF1C_LPR	OUT	Complement clock of low power differential clock pair. (no 50ohm shunt resistor to GND needed)
15	DIF1T_LPR	OUT	True clock of low power differential clock pair. (no 50ohm shunt resistor to GND needed)
16	OE1#	IN	Output Enable for DIF1 output. Control is as follows: 0 = enabled, 1 = Low-Low
17	GND	GND	Ground pin
18	VDD_IO	PWR	Power supply for low power differential outputs, nominal 1.05V to 3.3V
19	DIF0C_LPR	OUT	Complement clock of low power differential clock pair. (no 50ohm shunt resistor to GND needed)
20	DIF0T_LPR	OUT	True clock of low power differential clock pair. (no 50ohm shunt resistor to GND needed)

MLF Pin Description

PIN # (MLF)	PIN NAME	PIN TYPE	DESCRIPTION
1	VDDA	PWR	3.3V Power for the Analog Core
2	GNDA	GND	Ground for the Analog Core
3	OE3#	IN	Output Enable for DIF3 output. Control is as follows: 0 = enabled, 1 = Low-Low
4	DIF3C_LPR	OUT	Complement clock of low power differential clock pair. (no 50ohm shunt resistor to GND needed)
5	DIF3T_LPR	OUT	True clock of low power differential clock pair. (no 50ohm shunt resistor to GND needed)
6	VDD_IO	PWR	Power supply for low power differential outputs, nominal 1.05V to 3.3V
7	GND	GND	Ground pin
8	DIF2C_LPR	OUT	Complement clock of low power differential clock pair. (no 50ohm shunt resistor to GND needed)
9	DIF2T_LPR	OUT	True clock of low power differential clock pair. (no 50ohm shunt resistor to GND needed)
10	OE2#	IN	Output Enable for DIF2 output. Control is as follows: 0 = enabled, 1 = Low-Low
11	DIF1C_LPR	OUT	Complement clock of low power differential clock pair. (no 50ohm shunt resistor to GND needed)
12	DIF1T_LPR	OUT	True clock of low power differential clock pair. (no 50ohm shunt resistor to GND needed)
13	OE1#	IN	Output Enable for DIF1 output. Control is as follows: 0 = enabled, 1 = Low-Low
14	GND	GND	Ground pin
15	VDD_IO	PWR	Power supply for low power differential outputs, nominal 1.05V to 3.3V
16	DIF0C_LPR	OUT	Complement clock of low power differential clock pair. (no 50ohm shunt resistor to GND needed)
17	DIF0T_LPR	OUT	True clock of low power differential clock pair. (no 50ohm shunt resistor to GND needed)
18	OE0#	IN	Output Enable for DIF0 output. Control is as follows: 0 = enabled, 1 = Low-Low
19	DIF_INC	IN	Complement side of differential input clock
20	DIF_INT	IN	True side of differential input clock

Absolute Maximum Ratings

PARAMETER	SYMBOL	CONDITIONS	MIN	MAX	UNITS	Notes
Maximum Supply Voltage	VDDA	Core Supply Voltage		4.6	V	1,7
Maximum Supply Voltage	VDD_IO	Low-Voltage Differential I/O	0.99	3.8	V	1,7
Maximum Input Voltage	V _{IH}	3.3V LVCMOS Inputs		4.6	V	1,7,8
Minimum Input Voltage	V _{IL}	Any Input	V _{SS} - 0.5		V	1,7
Ambient Operating Temp	TambCOM	Commercial Range	0	70	°C	1
	TambIND	Industrial Range	-40	85	°C	1
Storage Temperature	T _s	-	-65	150	°C	1,7
Input ESD protection	ESD prot	Human Body Model	2000		V	1,7

Electrical Characteristics - Input/Supply/Common Output Parameters

PARAMETER	SYMBOL	CONDITIONS	MIN	MAX	UNITS	Notes
Supply Voltage	VDDA	Supply Voltage	3.000	3.600	V	1
Supply Voltage	VDDxx_IO	Low-Voltage Differential I/O Supply	0.99	3.600	V	1
Input High Voltage	V _{IHSE}	Single-ended inputs	2	V _{DD} + 0.3	V	1
Input Low Voltage	V _{ILSE}	Single-ended inputs	V _{SS} - 0.3	0.8	V	1
Differential Input High Voltage	V _{IHDIF}	Differential inputs (single-ended measurement)	600	1.15	V	1
Differential Input Low Voltage	V _{ILDIF}	Differential inputs (single-ended measurement)	V _{SS} - 0.3	300	mV	1
Input Slew Rate - DIF_IN	dv/dt	Measured differentially	0.4	8	V/ns	2
Input Leakage Current	I _{IN}	V _{IN} = V _{DD} , V _{IN} = GND	-5	5	uA	1
Operating Supply Current	I _{DD 3.3V}	VDDA supply current		20	mA	1
	I _{DD_IO_133M}	VDD_IO supply @ fOP = 133MHz		20	mA	1
Power Down Current (All OE# pins High)	I _{DD_SB 3.3V}	VDDA supply current, Input stopped, OE# pins all high		750	uA	1
	I _{DD_SBio}	VDD_IO supply, Input stopped, OE# pins all high		150	uA	1
Input Frequency	F _i	V _{DD} = 3.3 V	15	150	MHz	2
Pin Inductance	L _{pin}			7	nH	1
Input Capacitance	C _{IN}	Logic Inputs	1.5	5	pF	1
	C _{OUT}	Output pin capacitance		6	pF	1
OE# latency (at least one OE# is low)	T _{OE#LAT}	Number of clocks to enable or disable output from assertion/deassertion of OE#	1	3	periods	1
Clock stabilization time (from all OE# high to first OE# low).	T _{STAB}	Delay from assertion of first OE# to first clock out (assumes input clock running and device in power down state))		150	ns	1
Tdrive_OE#	T _{DROE#}	Output enable after OE# de-assertion		10	ns	1
Tfall_OE#	T _{FALL}	Fall/rise time of OE# inputs		5	ns	1
Trise_OE#	T _{RISE}			5	ns	1

AC Electrical Characteristics - DIF Low Power Differential Outputs

PARAMETER	SYMBOL	CONDITIONS	MIN	MAX	UNITS	NOTES
Rising Edge Slew Rate	t_{SLR}	Differential Measurement	1.5	4	V/ns	1,2
Falling Edge Slew Rate	t_{FLR}	Differential Measurement	1.5	4	V/ns	1,2
Slew Rate Variation	t_{SLVAR}	Single-ended Measurement		20	%	1
Maximum Output Voltage	V_{HIGH}	Includes overshoot		1150	mV	1
Minimum Output Voltage	V_{LOW}	Includes undershoot	-300		mV	1
Differential Voltage Swing	V_{SWING}	Differential Measurement	1200		mV	1
Crossing Point Voltage	V_{XABS}	Single-ended Measurement	300	550	mV	1,3,4
Crossing Point Variation	$V_{XABSVAR}$	Single-ended Measurement		140	mV	1,3,5
Duty Cycle Distortion	$D_{CYCDISO}$	Differential Measurement, $f_{IN} \leq 133.33\text{MHz}$		3	%	1,6
Additive Cycle to Cycle Jitter	$DIFJ_{C2CADD}$	Differential Measurement, Additive		15	ps	1
DIF[3:0] Skew	DIF_{SKEW}	Differential Measurement		50	ps	1
Propagation Delay	t_{PD}	Input to output Delay	2.5	3.5	ns	1
Additive Phase Jitter - PCIe Gen1	t_{phase_add} PCIG1	1.5MHz < 22MHz		6	ps Pk-Pk	1,9
Additive Phase Jitter - PCIe Gen2 High Band	t_{phase_add} PCIG2HI	High Band is 1.5MHz to Nyquist (50MHz)		0.16	ps rms	1,9
Additive Phase Jitter PCIe Gen2 Low Band	t_{phase_add} PCIG2LO	Low Band is 10KHz to 1.5MHz		0.07	ps rms	1,9
Additive Phase Jitter PCIe Gen3	t_{phase_add} PCIG2LO	2M-4M, 2M-5M filter		0.2	ps rms	1,9
Additive Phase Jitter QPI133 (6.4GBs, 12 UI)	t_{phase_add} QPI6G4	11MHz to 33MHz		0.04	ps rms	1,9

Notes on Electrical Characteristics (all measurements use 9LRS3187B as clock source and $R_S=33\text{ohms}/C_L=2\text{pF}$ test load):

¹Guaranteed by design and characterization, not 100% tested in production.

²Slew rate measured through V_{swing} centered around differential zero

³ V_{xabs} is defined as the voltage where $CLK = CLK\#$

⁴Only applies to the differential rising edge (CLK rising and CLK# falling)

⁵Defined as the total variation of all crossing voltages of CLK rising and CLK# falling. Matching applies to rising edge rate of CLK and falling edge of CLK#. It is measured using a +/-75mV window centered on the average cross point where CLK meets CLK#.

⁶This figure refers to the maximum distortion of the input wave form.

⁷Operation under these conditions is neither implied, nor guaranteed.

⁸Maximum input voltage is not to exceed maximum VDD

⁹The 9DBL411B has no PLL, so the part itself contributes very little jitter to the input clock. But this also means that the 9DBL411 cannot 'de-jitter' a noisy input clock. Values calculated per PCI SIG and per Intel Clock Jitter tool version 1.5

20-pin TSSOP Marking Diagrams

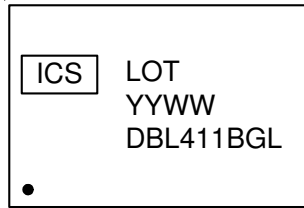
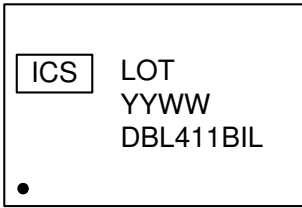

20-pin MLF Marking Diagrams

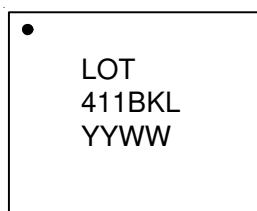
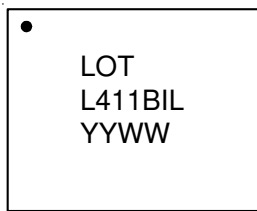

20-pin TSSOP Package Drawing and Dimensions

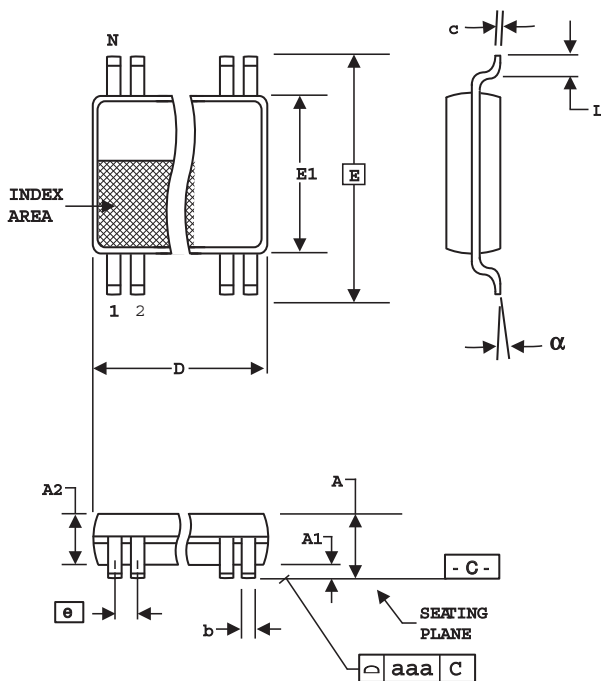

20-Lead, 4.40 mm. Body, 0.65 mm. Pitch TSSOP
(173 mil) (25.6 mil)

SYMBOL	In Millimeters		In Inches	
	COMMON DIMENSIONS MIN	COMMON DIMENSIONS MAX	COMMON DIMENSIONS MIN	COMMON DIMENSIONS MAX
A	--	1.20	--	.047
A1	0.05	0.15	.002	.006
A2	0.80	1.05	.032	.041
b	0.19	0.30	.007	.012
c	0.09	0.20	.0035	.008
D	SEE VARIATIONS		SEE VARIATIONS	
E	6.40 BASIC		0.252 BASIC	
E1	4.30	4.50	.169	.177
e	0.65 BASIC		0.0256 BASIC	
L	0.45	0.75	.018	.030
N	SEE VARIATIONS		SEE VARIATIONS	
a	0°	8°	0°	8°
aaa	--	0.10	--	.004

VARIATIONS

N	D mm.		D (inch)	
	MIN	MAX	MIN	MAX
20	6.40	6.60	.252	.260

Reference Doc.: JEDEC Publication 95, MO-153

10-0035

20-pin MLF Package Drawing and Dimensions

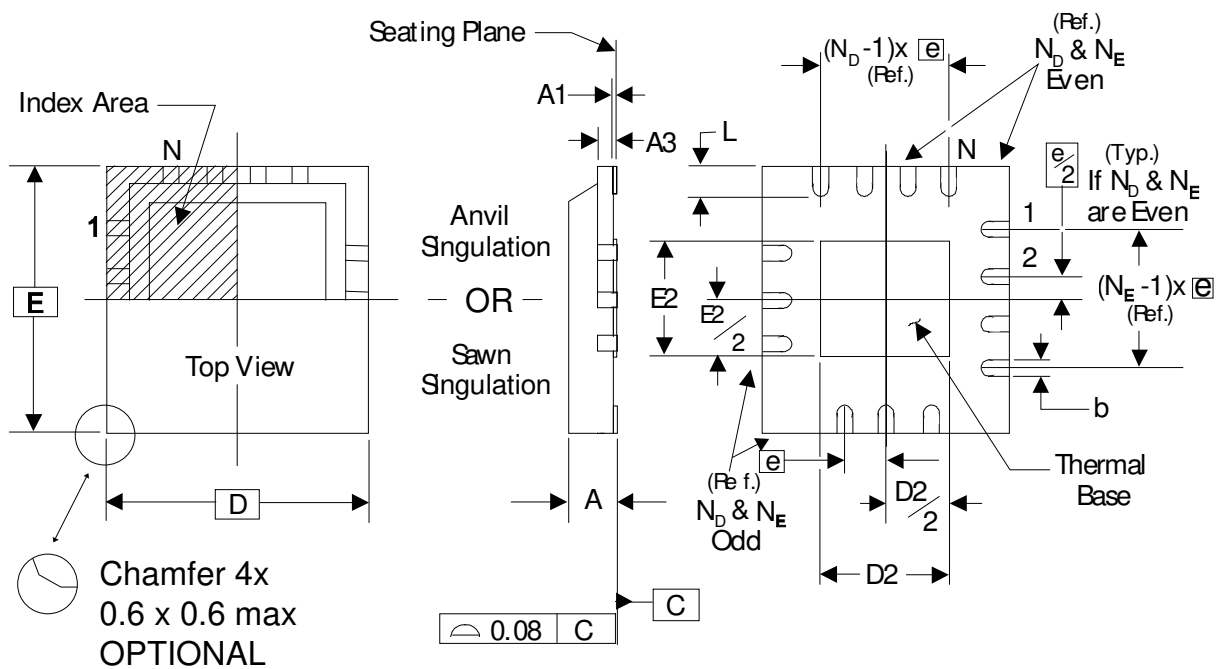

THERMALLY ENHANCED, VERY THIN, FINE PITCH
QUAD FLAT / NO LEAD PLASTIC PACKAGE

DIMENSIONS

SYMBOL	MIN.	MAX.
A	0.8	1.0
A1	0	0.05
A3	0.20 Reference	
b	0.18	0.3
e	0.50 BASIC	

DIMENSIONS

SYMBOL	ICS 20L TOLERANCE
N	20
N _D	5
N _E	5
D x E BASIC	4.00 x 4.00
D2 MIN. / MAX.	2.00 / 2.25
E2 MIN. / MAX.	2.00 / 2.25
L MIN. / MAX.	0.45 / 0.65

Ordering Information

Part / Order Number	Shipping Packaging	Package	Temperature
9DBL411BKLF	Trays	20-pin MLF	0 to +70°C
9DBL411BKLF	Tape and Reel	20-pin MLF	0 to +70°C
9DBL411BGLF	Tubes	20-pin TSSOP	0 to +70°C
9DBL411BGLFT	Tape and Reel	20-pin TSSOP	0 to +70°C
9DBL411BKILF	Trays	20-pin MLF	-40 to +85°C
9DBL411BKILFT	Tape and Reel	20-pin MLF	-40 to +85°C
9DBL411BGILF	Tubes	20-pin TSSOP	-40 to +85°C
9DBL411BGILFT	Tape and Reel	20-pin TSSOP	-40 to +85°C

"LF" suffix to the part number are the Pb-Free configuration and are RoHS compliant.
"B" is the device revision designator (will not correlate to the datasheet revision).

Revision History

Rev.	Issue Date	Description	Page #
0.1	1/8/2010	Initial Release. Compared with A rev the following have changed: 1. Added I-temp version 2. Updated electrical tables for I-temp 3. Revised Phase Jitter specs and added QPI.	
A	1/8/2010	Released to final.	
B	4/23/2010	Changed Input Frequency from 33 min to 15 MHz min	5
C	10/18/2010	Updated Supply Voltage min/max ratings.	5
D	3/22/2012	Updated phase jitter table for PCIe Gen3.	
E	6/28/2012	Typo in "Differential Input Low Voltage" units; changed "V" to "mV"	
F	8/16/2013	Correct typo on the top-side marking for MLF (commercial temp.) from "L411BKL" to "411BKL"	

This product is protected by United States Patent NO. 7, 342, 420 and other patents.

Innovate with IDT and accelerate your future networks. Contact:

www.IDT.com

For Sales

800-345-7015
408-284-8200
Fax: 408-284-2775

For Tech Support

408-284-6578
pcclockhelp@idt.com

Corporate Headquarters

Integrated Device Technology, Inc.
6024 Silver Creek Valley Road
San Jose, CA 95138
United States
800 345 7015
+408 284 8200 (outside U.S.)



© 2013 Integrated Device Technology, Inc. All rights reserved. Product specifications subject to change without notice. IDT, ICS, and the IDT logo are trademarks of Integrated Device Technology, Inc. Accelerated Thinking is a service mark of Integrated Device Technology, Inc. All other brands, product names and marks are or may be trademarks or registered trademarks used to identify products or services of their respective owners.
Printed in USA