



Chipsmall Limited consists of a professional team with an average of over 10 year of expertise in the distribution of electronic components. Based in Hongkong, we have already established firm and mutual-benefit business relationships with customers from,Europe,America and south Asia,supplying obsolete and hard-to-find components to meet their specific needs.

With the principle of “Quality Parts,Customers Priority,Honest Operation,and Considerate Service”,our business mainly focus on the distribution of electronic components. Line cards we deal with include Microchip,ALPS,ROHM,Xilinx,Pulse,ON,Everlight and Freescale. Main products comprise IC,Modules,Potentiometer,IC Socket,Relay,Connector.Our parts cover such applications as commercial,industrial, and automotives areas.

We are looking forward to setting up business relationship with you and hope to provide you with the best service and solution. Let us make a better world for our industry!



Contact us

Tel: +86-755-8981 8866 Fax: +86-755-8427 6832

Email & Skype: info@chipsmall.com Web: www.chipsmall.com

Address: A1208, Overseas Decoration Building, #122 Zhenhua RD., Futian, Shenzhen, China



San Ace 60L LG type

High Air Flow Long Life Fan

High Air Flow Long Life Fan 60mm

Features

Long Life

The San Ace 60L LG type has an expected life of 180,000 hours (approximately 20 years), 1.8 times that of our conventional long life fan,^{*1} making this fan ideal for equipment that must operate without maintenance for extended periods.

High Air Flow and High Static Pressure

The maximum air flow of the San Ace 60L LG type is approximately 1.8 times and its maximum static pressure is about 3.5 times that of our conventional long life fan.^{*1}

Low Power Consumption

The power consumption of this new fan is about 29% lower than that of our conventional long life fan.^{*2}

Low Noise

Its sound pressure level is 4 dB(A) lower than that of our conventional long life fan.^{*2}



*1: Specification of Model No. 9LG0612P4S001. Our conventional long life fan is 60 x 60 x 25 mm "San Ace 60L", Model No. 109L0612G401.

*2: Specification of Model No. 9LG0612P4H001. Our conventional long life fan is 60 x 60 x 25 mm "San Ace 60L", Model No. 109L0612G401.

60×60×25mm

Specifications

Model No.	Rated Voltage [V]	Operating Voltage Range [V]	PWM Duty Cycle [%] ^{Note1,2)}	Rated Current [A]	Rated Input [W]	Rated Speed [min ⁻¹]	Max. Air Flow [m ³ /min] [CFM]	Max. Static Pressure [Pa] [inch H ₂ O]	SPL [dB(A)]	Operating Temperature [°C]	Expected Life [h]	
9LG0612P4S001	12	10.8 to 13.2	100	0.67	8.04	11,000	1.40 49.4	300 1.204	53	-10 to +70	180,000	
			20	0.06	0.72	2,900	0.36 12.7	20.8 0.083	20			
9LG0612P4J001			100	0.39	4.68	8,650	1.10 38.8	182 0.730	47			
			20	0.03	0.36	1,150	0.13 4.8	3.3 0.013	14			
9LG0612P4H001			100	0.17	2.04	6,150	0.78 27.5	97 0.389	35			
			20	0.03	0.36	1,350	0.17 6.0	4.7 0.018	14			
9LG0612P4M001		100	0.09	1.08	4,200	0.53 18.7	45 0.180	24				
		20	0.03	0.36	900	0.11 3.8	2.0 0.008	14				
9LG0624P4S001		24	21.6 to 26.4	100	0.34	8.16	11,000	1.40 49.4	300 1.204			53
				20	0.03	0.72	2,900	0.36 12.7	20.8 0.083			20
9LG0624P4J001				100	0.19	4.56	8,650	1.10 38.8	182 0.730			47
				20	0.02	0.48	2,200	0.28 9.8	12.0 0.048			17
9LG0624P4H001	100			0.08	1.92	6,150	0.78 27.5	97 0.389	35			
	20			0.02	0.48	1,300	0.16 5.6	4.3 0.017	14			
9LG0624P4M001	100		0.04	0.96	4,200	0.53 18.7	45 0.180	24				
	20		0.01	0.24	800	0.10 3.5	1.6 0.006	14				
9LG0648P4S001	48		36 to 72	100	0.18	8.64	11,000	1.40 49.4	305 1.224	53		
				20	0.02	0.96	2,900	0.36 12.7	20.8 0.083	20		
9LG0648P4J001				100	0.10	4.80	8,650	1.10 38.8	182 0.730	47		
				20	0.02	0.96	2,100	0.26 9.1	10.7 0.042	17		
9LG0648P4H001		100		0.06	2.88	6,150	0.78 27.5	97 0.389	35			
		20		0.02	0.96	1,000	0.12 4.2	2.5 0.010	14			
9LG0648P4M001		100	0.04	1.92	4,200	0.53 18.7	45 0.180	24				
		20	0.02	0.96	650	0.08 2.8	1.0 0.004	14				

Note1: PWM Frequency : 25kHz Note2: Fans do not rotate when PWM duty cycle is 0%.

Common Specifications

- Material Frame : Aluminum, Impeller : Plastics (Flammability: UL94V-1)
- Expected Life Varies for each model (L10: Survival rate: 90% at 60°C, rated voltage, and continuously run in a free air state)
- Motor Protection System Current blocking function and Reverse polarity protection
- Dielectric Strength 50/60 Hz, 500VAC, 1 minute (between lead conductor and frame)
- Sound Pressure Level (SPL) Expressed as the value at 1m from air inlet side
- Operating Temperature Varies for each model (Non-condensing)
- Storage Temperature -30°C to +70°C (Non-Condensing)
- Lead Wire ⊕Red ⊖Black
Sensor: Yellow Control: Brown
- Mass Approx. 100g

60mm

Air Flow - Static pressure Characteristics

PWM Duty Cycle

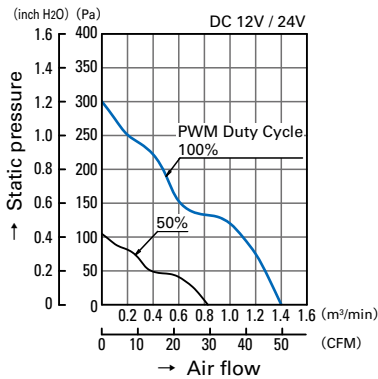

9LG0612P4S001
9LG0624P4S001

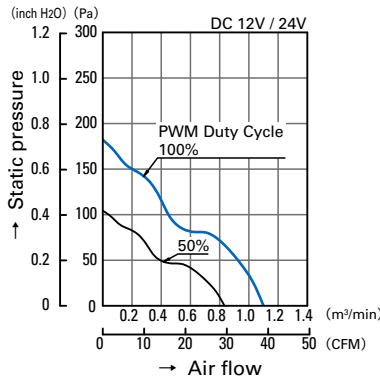

9LG0612P4J001
9LG0624P4J001

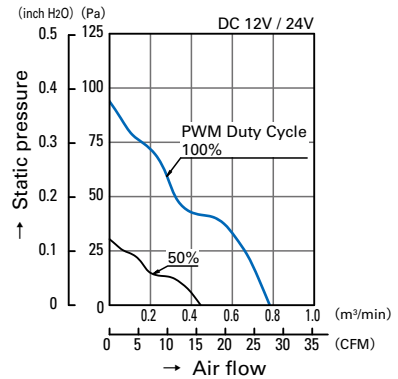

9LG0612P4H001
9LG0624P4H001

Operating Voltage Range

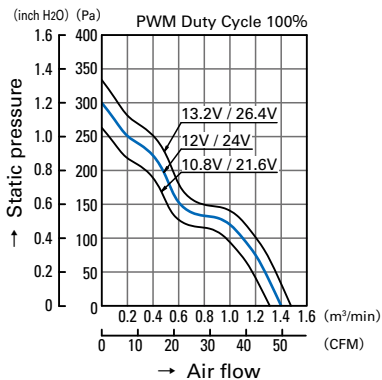

9LG0612P4S001
9LG0624P4S001

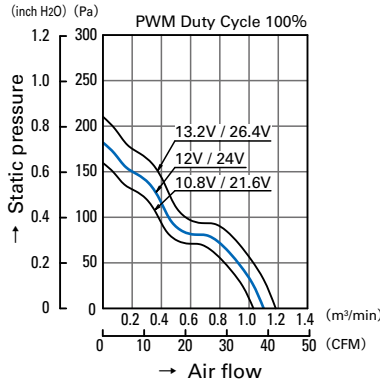

9LG0612P4J001
9LG0624P4J001

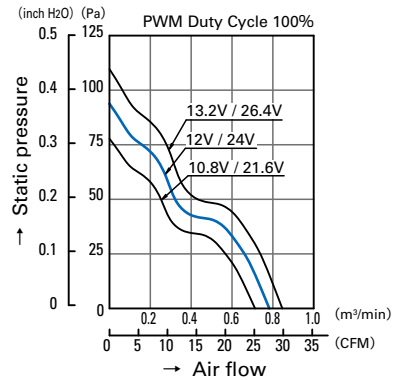

9LG0612P4H001
9LG0624P4H001

PWM Duty Cycle

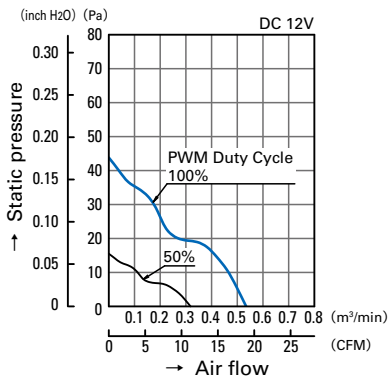

9LG0612P4M001

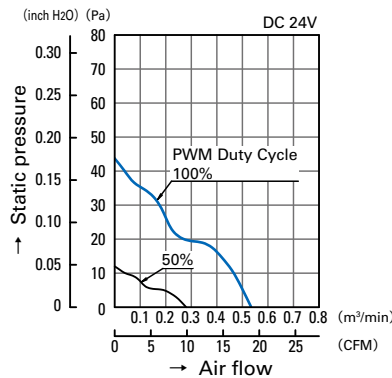

9LG0624P4M001

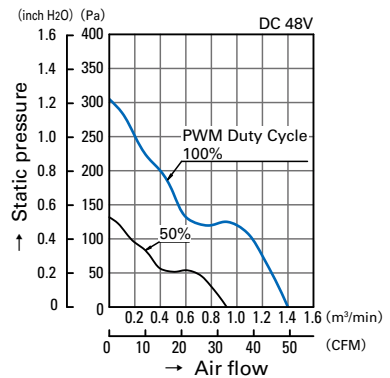

9LG0648P4S001

Operating Voltage Range

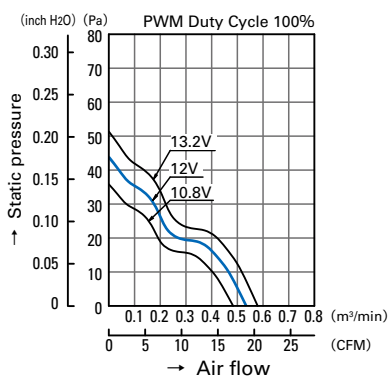

9LG0612P4M001

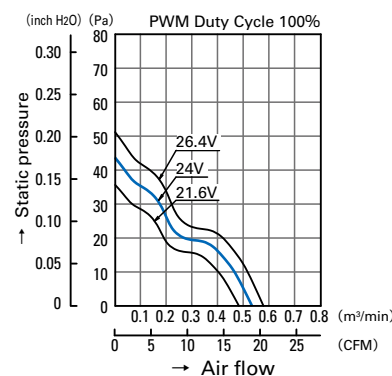

9LG0624P4M001

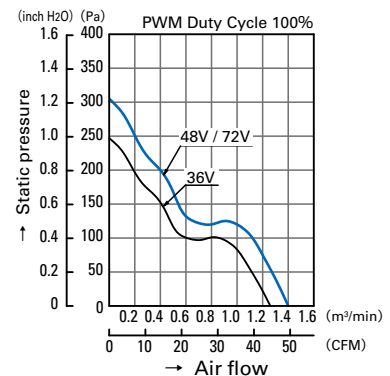

9LG0648P4S001

Air Flow - Static pressure Characteristics

PWM Duty Cycle

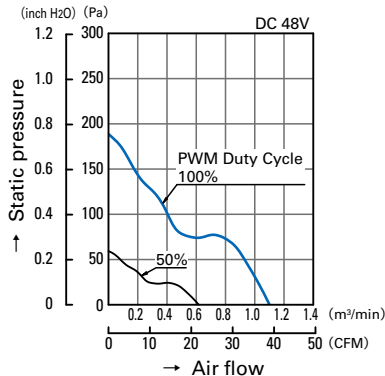

9LG0648P4J001

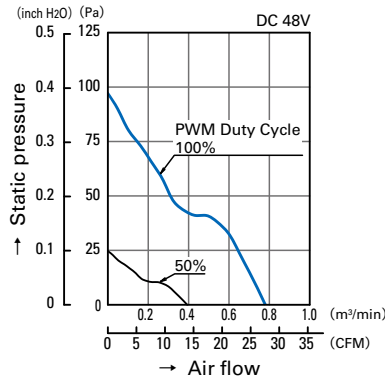

9LG0648P4H001

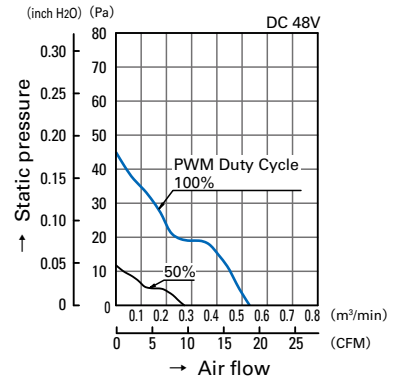

9LG0648P4M001

Operating Voltage Range

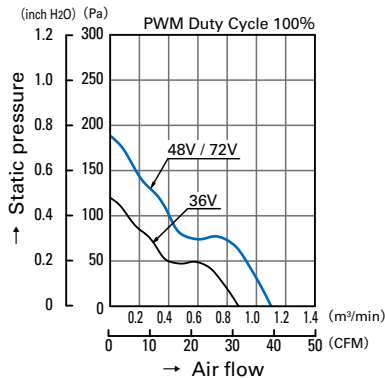

9LG0648P4J001

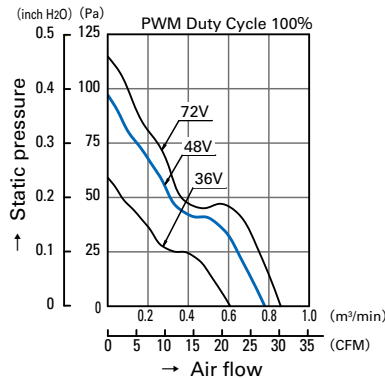

9LG0648P4H001

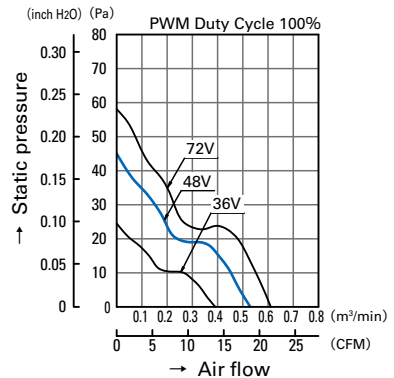

9LG0648P4M001

PWM Duty - Speed Characteristics Example

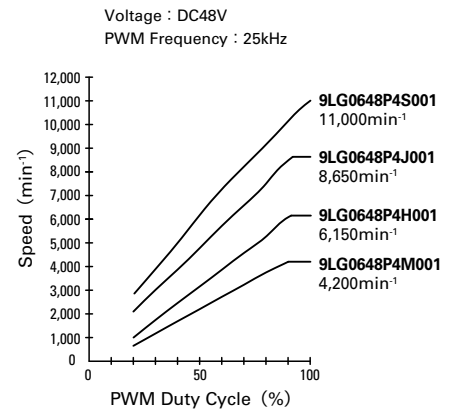
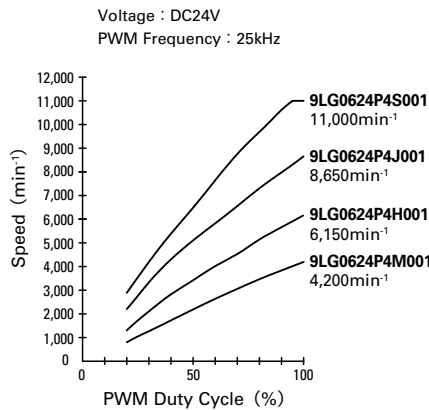
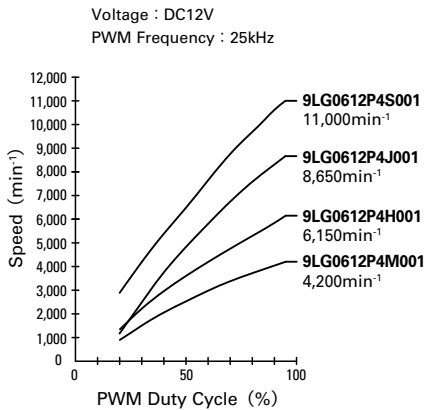

PWM Input Signal Example

Input Signal Waveform

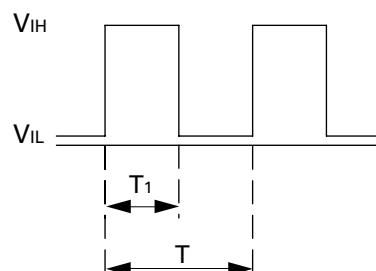

V_{IH}=4.75V to 5.25V

V_{IL}=0V to 0.4V

$$\text{PWM Duty Cycle (\%)} = \frac{T_1}{T} \times 100$$

$$\text{PWM Frequency 25 (kHz)} = \frac{1}{T}$$

Source Current : 1mA Max. at control voltage 0V

Sink Current : 1mA Max. at control voltage 5.25V

Control Terminal Voltage : 5.25V Max. (Open Circuit)

When the control lead wire is open, the fan speed is the same as the one at 100% PWM duty cycle.

Either TTL input, open collector or open drain can be used for PWM control input signal.

Example of Connection Schematic

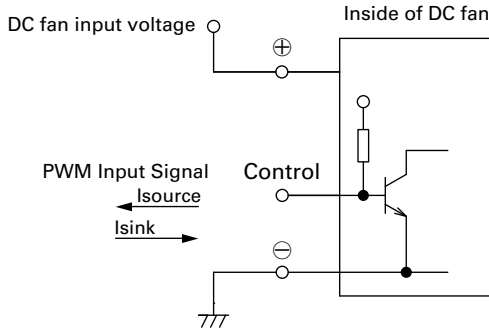

Specifications for Pulse Sensors

Output Circuit : Open Collector

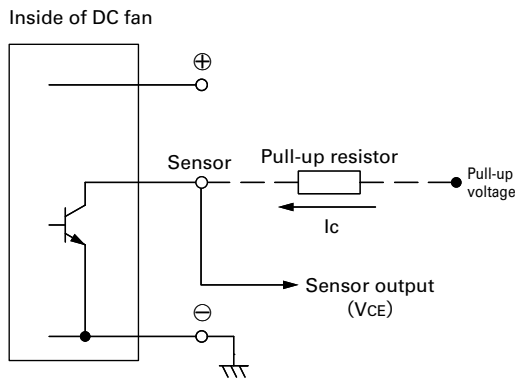

Rated Voltage 12V Fan

$V_{CE} = +13.8V$ Max.
 $I_c = 5mA$ Max. [$V_{OL} = V_{CE} (SAT) = 0.6V$ Max.]

Rated Voltage 24V Fan

• 9LG0624P4S001
 $V_{CE} = +30V$ Max.
 $I_c = 10mA$ Max. [$V_{OL} = V_{CE} (SAT) = 0.6V$ Max.]
 • 9LG0624P4J001, 9LG0624P4H001,
 9LG0624P4M001
 $V_{CE} = +27.6V$ Max.
 $I_c = 5mA$ Max. [$V_{OL} = V_{CE} (SAT) = 0.8V$ Max.]

Rated Voltage 48V Fan

• 9LG0648P4S001, 9LG0648P4J001
 $V_{CE} = +72V$ Max.
 $I_c = 10mA$ 以下 [$V_{OL} = V_{CE} (SAT) = 1V$ Max.]
 • 9LG0648P4H001, 9LG0648P4M001
 $V_{CE} = +72V$ Max.
 $I_c = 10mA$ Max. [$V_{OL} = V_{CE} (SAT) = 0.6V$ Max.]

Output Waveform
 (Need pull-up resistor)

In case of steady running

(One revolution)

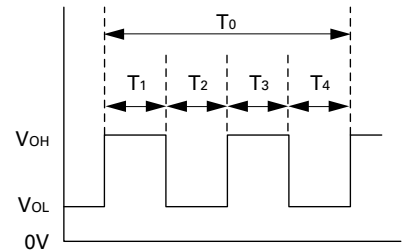

$$T_{1-4} \doteq (1/4) T_0$$

$$T_{1-4} \doteq (1/4) T_0 = 60/4N \text{ (sec)}$$

$$N = \text{Fan speed (min}^{-1}\text{)}$$

Dimensions (unit : mm)

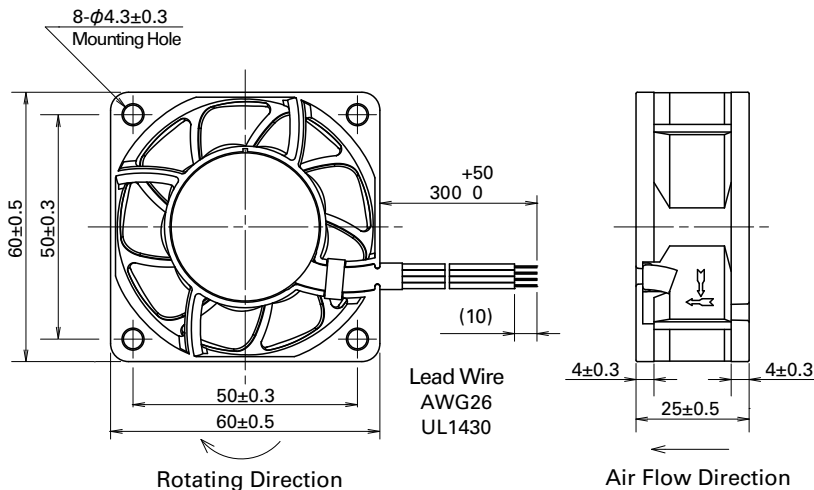

Reference Dimension of Mounting Holes and Vent Opening (unit : mm)

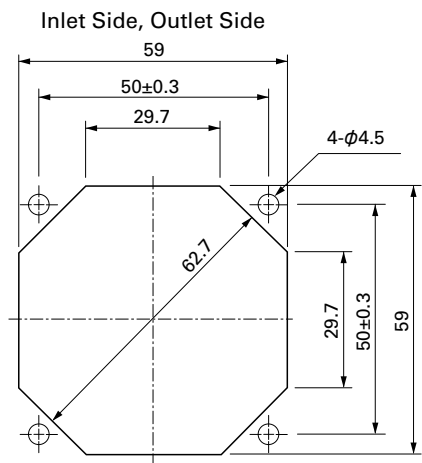

Notice

- The products shown in the catalog are subject to Japanese Export Control Law. Diversion contrary to the law of exporting country is prohibited.
- To protect against electrolytic corrosion that may occur in locations with strong electromagnetic noise, we provide fans that are unaffected by electrolytic corrosion.

SANYO DENKI CO., LTD.

1-15-1, Kita-otsuka, Toshima-ku, Tokyo 170-8451, Japan. PHONE : + 81 3 3917 5151

<http://www.sanyodenki.com>

The names of companies and/or their products specified in this catalog are the trade names, and/or trademarks and/or registered trademarks of such respective companies. "San Ace" is a trademark of SANYO DENKI CO.,LTD.

Specifications are subject to change without notice.

CATALOG NO. C1020B001 '13.6