



Chipsmall Limited consists of a professional team with an average of over 10 year of expertise in the distribution of electronic components. Based in Hongkong, we have already established firm and mutual-benefit business relationships with customers from,Europe,America and south Asia,supplying obsolete and hard-to-find components to meet their specific needs.

With the principle of “Quality Parts,Customers Priority,Honest Operation,and Considerate Service”,our business mainly focus on the distribution of electronic components. Line cards we deal with include Microchip,ALPS,ROHM,Xilinx,Pulse,ON,Everlight and Freescale. Main products comprise IC,Modules,Potentiometer,IC Socket,Relay,Connector.Our parts cover such applications as commercial,industrial, and automotives areas.

We are looking forward to setting up business relationship with you and hope to provide you with the best service and solution. Let us make a better world for our industry!



Contact us

Tel: +86-755-8981 8866 Fax: +86-755-8427 6832

Email & Skype: info@chipsmall.com Web: www.chipsmall.com

Address: A1208, Overseas Decoration Building, #122 Zhenhua RD., Futian, Shenzhen, China



ULTRA MOBILE PC/MOBILE INTERNET DEVICE

ICS9UMS9633B

Recommended Application:

Poulsbo Based Ultra-Mobile PC (UMPC)

Output Features:

- 3 - CPU low power differential push-pull pairss
- 3 - SRC low power differential push-pull pairs
- 1 - LCD100 SSCD low power differential push-pull pair
- 1 - DOT96 low power differential push-pull pair
- 1 - REF, 14.31818MHz, 3.3V SE output

Features/Benefits:

- Supports Dothan ULV CPUs with 67 to 167 MHz CPU outputs
- Dedicated TEST/SEL and TEST/MODE pins saves isolation resistors on pins
- CPU STOP# input for power managment
- Fully integrated Vreg
- Integrated series resistors on differential outputs
- 1.5V VDD IO operation, 3.3V VDD core and REF supply pin for REF
- Industrial Temperature (-40 to +85C) version available

SSOP Pin Configuration

REF	1	48	VDDREF_3.3
GNDREF	2	47	X1
VDDCORE_3.3	3	46	X2
FSC_L	4	45	CLKPWRGD#/PD_3.3
TEST_MODE	5	44	CPU_STOP#
TEST_SEL	6	43	CPUT0_LPR
SCLK	7	42	CPUC0_LPR
SDATA	8	41	VDDIO_1.5
VDDCORE_3.3	9	40	GNDCPU
VDDIO_1.5	10	39	CPUT1_LPR
DOT96C_LPR	11	38	CPUC1_LPR
DOT96T_LPR	12	37	VDDCORE_3.3
GNDDOT	13	36	VDDIO_1.5
GNDLCD	14	35	GNDCPU
LCD100C_LPR	15	34	CPUT2_LPR
LCD100T_LPR	16	33	CPUC2_LPR
VDDIO_1.5	17	32	FSB_L
VDDCORE_3.3	18	31	*CR#2
*CR#0	19	30	SRCT2_LPR
GNDSRC	20	29	SRCC2_LPR
SRCC0_LPR	21	28	GNDSRC
SRCT0_LPR	22	27	SRCT1_LPR
*CR#1	23	26	SRCC1_LPR
VDDCORE_3.3	24	25	VDDIO_1.5

48 SSOP Package

* indicates inputs with internal pull up of ~10Kohm to 3.3V

SSOP Pin Description

PIN #	PIN NAME	TYPE	DESCRIPTION
1	REF	OUT	14.318 MHz reference clock.
2	GNDREF	PWR	Ground pin for the REF outputs.
3	VDDCORE_3.3	PWR	3.3V power for the PLL core
4	FSC_L	IN	Low threshold input for CPU frequency selection. Refer to input electrical characteristics for Vil_FS and Vih_FS values.
5	TEST_MODE	IN	TEST_MODE is a real time input to select between Hi-Z and REF/N divider mode while in test mode. Refer to Test Clarification Table.
6	TEST_SEL	IN	TEST_SEL: latched input to select TEST MODE 1 = All outputs are tri-stated for test 0 = All outputs behave normally.
7	SCLK	IN	Clock pin of SMBus circuitry, 5V tolerant.
8	SDATA	I/O	Data pin for SMBus circuitry, 3.3V tolerant.
9	VDDCORE_3.3	PWR	3.3V power for the PLL core
10	VDDIO_1.5	PWR	Power supply for low power differential outputs, nominal 1.5V.
11	DOT96C_LPR	OUT	Complement clock of low power differential pair for 96.00MHz DOT clock. No 50ohm resistor to GND needed. No Rs needed.
12	DOT96T_LPR	OUT	True clock of low power differential pair for 96.00MHz DOT clock. No 50ohm resistor to GND needed. No Rs needed.
13	GNDDOT	PWR	Ground pin for DOT clock output
14	GNDLCD	PWR	Ground pin for LCD clock output
15	LCD100C_LPR	OUT	Complement clock of low power differential pair for LCD100 SS clock. No 50ohm resistor to GND needed. No Rs needed.
16	LCD100T_LPR	OUT	True clock of low power differential pair for LCD100 SS clock. No 50ohm resistor to GND needed. No Rs needed.
17	VDDIO_1.5	PWR	Power supply for low power differential outputs, nominal 1.5V.
18	VDDCORE_3.3	PWR	3.3V power for the PLL core
19	*CR#0	IN	Clock request for SRC0, 0 = enable, 1 = disable
20	GNDSRC	PWR	Ground pin for the SRC outputs
21	SRCC0_LPR	OUT	Complementary clock of differential 0.8V push-pull SRC output with integrated 33ohm series resistor. No 50ohm resistor to GND needed.
22	SRCT0_LPR	OUT	True clock of differential 0.8V push-pull SRC output with integrated 33ohm series resistor. No 50ohm resistor to GND needed.
23	*CR#1	IN	Clock request for SRC1, 0 = enable, 1 = disable
24	VDDCORE_3.3	PWR	3.3V power for the PLL core

SSOP Pin Description (continued)

PIN #	PIN NAME	TYPE	DESCRIPTION
25	VDDIO_1.5	PWR	Power supply for low power differential outputs, nominal 1.5V.
26	SRCC1_LPR	OUT	Complementary clock of differential 0.8V push-pull SRC output with integrated 33ohm series resistor. No 50ohm resistor to GND needed.
27	SRCT1_LPR	OUT	True clock of differential 0.8V push-pull SRC output with integrated 33ohm series resistor. No 50ohm resistor to GND needed.
28	GNDSRC	PWR	Ground pin for the SRC outputs
29	SRCC2_LPR	OUT	Complementary clock of differential 0.8V push-pull SRC output with integrated 33ohm series resistor. No 50ohm resistor to GND needed.
30	SRCT2_LPR	OUT	True clock of differential 0.8V push-pull SRC output with integrated 33ohm series resistor. No 50ohm resistor to GND needed.
31	*CR#2	IN	Clock request for SRC2, 0 = enable, 1 = disable
32	FSB_L	IN	Low threshold input for CPU frequency selection. Refer to input electrical characteristics for Vil_FS and Vih_FS values.
33	CPUC2_LPR	OUT	Complementary clock of differential pair 0.8V push-pull CPU outputs with integrated 33ohm series resistor. No 50 ohm resistor to GND needed.
34	CPUT2_LPR	OUT	True clock of differential pair 0.8V push-pull CPU outputs with integrated 33ohm series resistor. No 50 ohm resistor to GND needed.
35	GNDCPU	PWR	Ground pin for the CPU outputs
36	VDDIO_1.5	PWR	Power supply for low power differential outputs, nominal 1.5V.
37	VDDCORE_3.3	PWR	3.3V power for the PLL core
38	CPUC1_LPR	OUT	Complementary clock of differential pair 0.8V push-pull CPU outputs with integrated 33ohm series resistor. No 50 ohm resistor to GND needed.
39	CPUT1_LPR	OUT	True clock of differential pair 0.8V push-pull CPU outputs with integrated 33ohm series resistor. No 50 ohm resistor to GND needed.
40	GNDCPU	PWR	Ground pin for the CPU outputs
41	VDDIO_1.5	PWR	Power supply for low power differential outputs, nominal 1.5V.
42	CPUC0_LPR	OUT	Complementary clock of differential pair 0.8V push-pull CPU outputs with integrated 33ohm series resistor. No 50 ohm resistor to GND needed.
43	CPUT0_LPR	OUT	True clock of differential pair 0.8V push-pull CPU outputs with integrated 33ohm series resistor. No 50 ohm resistor to GND needed.
44	CPU_STOP#	IN	Stops all CPU clocks, except those set to be free running clocks
45	CLKPWRGD#/PD_3.3	IN	This 3.3V LVTTTL input is a level sensitive strobe used to determine when latch inputs are valid and are ready to be sampled. This is an active low input. / Asynchronous active high input pin used to place the device into a power down state.
46	X2	OUT	Crystal output, Nominally 14.318MHz
47	X1	IN	Crystal input, Nominally 14.318MHz.
48	VDDREF_3.3	PWR	Power pin for the XTAL and REF clocks, nominal 3.3V

MLF Pin Configuration

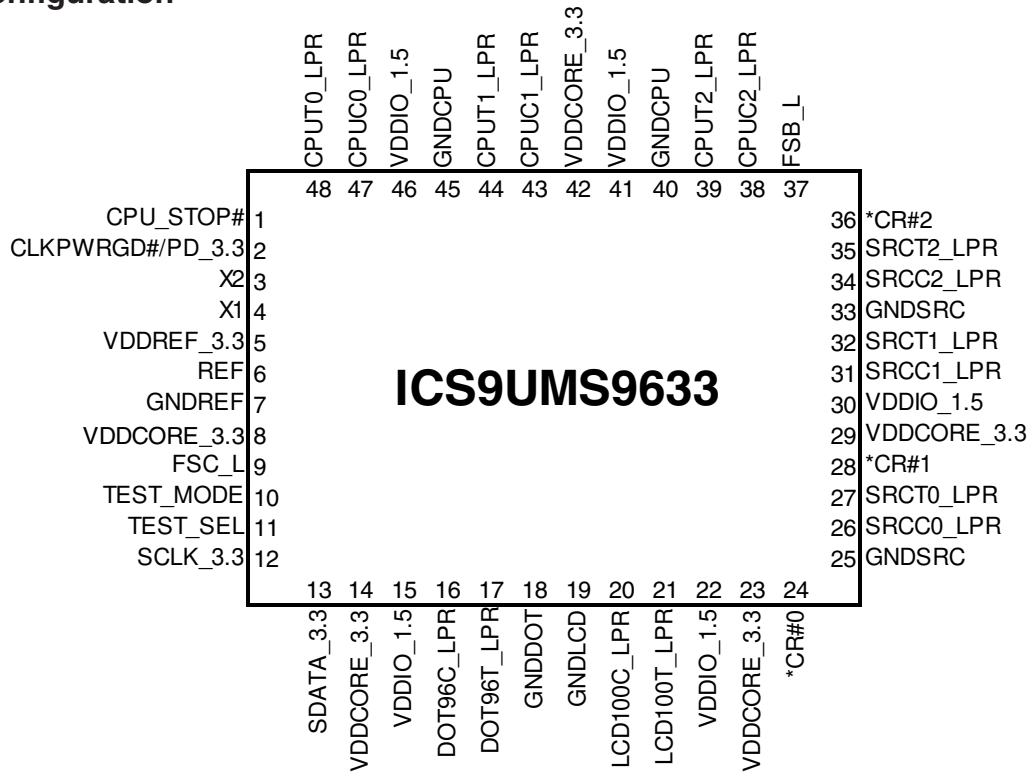

48-pin MLF, 6x6 mm, 0.4mm pitch

* indicates inputs with internal pull up of ~10Kohm to 3.3V

MLF Pin Description

PIN #	PIN NAME	TYPE	DESCRIPTION
1	CPU_STOP#	IN	Stops all CPU clocks, except those set to be free running clocks
2	CLKPWRGD#/PD_3.3	IN	This 3.3V LVTTTL input is a level sensitive strobe used to determine when latch inputs are valid and are ready to be sampled. This is an active low input. / Asynchronous active high input pin used to place the device into a power down state.
3	X2	OUT	Crystal output, Nominally 14.318MHz
4	X1	IN	Crystal input, Nominally 14.318MHz.
5	VDDREF_3.3	PWR	Power pin for the XTAL and REF clocks, nominal 3.3V
6	REF	OUT	14.318 MHz reference clock.
7	GNDREF	PWR	Ground pin for the REF outputs.
8	VDDCORE_3.3	PWR	3.3V power for the PLL core
9	FSC_L	IN	Low threshold input for CPU frequency selection. Refer to input electrical characteristics for Vil_FS and Vih_FS values.
10	TEST_MODE	IN	TEST_MODE is a real time input to select between Hi-Z and REF/N divider mode while in test mode. Refer to Test Clarification Table.
11	TEST_SEL	IN	TEST_SEL: latched input to select TEST MODE 1 = All outputs are tri-stated for test 0 = All outputs behave normally.
12	SCLK_3.3	IN	Clock pin of SMBus circuitry, 3.3V tolerant.
13	SDATA_3.3	I/O	Data pin for SMBus circuitry, 3.3V tolerant.
14	VDDCORE_3.3	PWR	3.3V power for the PLL core
15	VDDIO_1.5	PWR	Power supply for low power differential outputs, nominal 1.5V.
16	DOT96C_LPR	OUT	Complement clock of low power differential pair for 96.00MHz DOT clock. No 50ohm resistor to GND needed. No Rs needed.
17	DOT96T_LPR	OUT	True clock of low power differential pair for 96.00MHz DOT clock. No 50ohm resistor to GND needed. No Rs needed.
18	GNDDOT	PWR	Ground pin for DOT clock output
19	GNDLCD	PWR	Ground pin for LCD clock output
20	LCD100C_LPR	OUT	Complement clock of low power differential pair for LCD100 SS clock. No 50ohm resistor to GND needed. No Rs needed.
21	LCD100T_LPR	OUT	True clock of low power differential pair for LCD100 SS clock. No 50ohm resistor to GND needed. No Rs needed.
22	VDDIO_1.5	PWR	Power supply for low power differential outputs, nominal 1.5V.
23	VDDCORE_3.3	PWR	3.3V power for the PLL core
24	*CR#0	IN	Clock request for SRC0, 0 = enable, 1 = disable

MLF Pin Description (continued)

PIN #	PIN NAME	TYPE	DESCRIPTION
25	GNDSRC	PWR	Ground pin for the SRC outputs
26	SRCC0_LPR	OUT	Complementary clock of differential 0.8V push-pull SRC output with integrated 33ohm series resistor. No 50ohm resistor to GND needed.
27	SRCT0_LPR	OUT	True clock of differential 0.8V push-pull SRC output with integrated 33ohm series resistor. No 50ohm resistor to GND needed.
28	*CR#1	IN	Clock request for SRC1, 0 = enable, 1 = disable
29	VDDCORE_3.3	PWR	3.3V power for the PLL core
30	VDDIO_1.5	PWR	Power supply for low power differential outputs, nominal 1.5V.
31	SRCC1_LPR	OUT	Complementary clock of differential 0.8V push-pull SRC output with integrated 33ohm series resistor. No 50ohm resistor to GND needed.
32	SRCT1_LPR	OUT	True clock of differential 0.8V push-pull SRC output with integrated 33ohm series resistor. No 50ohm resistor to GND needed.
33	GNDSRC	PWR	Ground pin for the SRC outputs
34	SRCC2_LPR	OUT	Complementary clock of differential 0.8V push-pull SRC output with integrated 33ohm series resistor. No 50ohm resistor to GND needed.
35	SRCT2_LPR	OUT	True clock of differential 0.8V push-pull SRC output with integrated 33ohm series resistor. No 50ohm resistor to GND needed.
36	*CR#2	IN	Clock request for SRC2, 0 = enable, 1 = disable
37	FSB_L	IN	Low threshold input for CPU frequency selection. Refer to input electrical characteristics for Vil_FS and Vih_FS values.
38	CPUC2_LPR	OUT	Complementary clock of differential pair 0.8V push-pull CPU outputs with integrated 33ohm series resistor. No 50 ohm resistor to GND needed.
39	CPUT2_LPR	OUT	True clock of differential pair 0.8V push-pull CPU outputs with integrated 33ohm series resistor. No 50 ohm resistor to GND needed.
40	GNDCPU	PWR	Ground pin for the CPU outputs
41	VDDIO_1.5	PWR	Power supply for low power differential outputs, nominal 1.5V.
42	VDDCORE_3.3	PWR	3.3V power for the PLL core
43	CPUC1_LPR	OUT	Complementary clock of differential pair 0.8V push-pull CPU outputs with integrated 33ohm series resistor. No 50 ohm resistor to GND needed.
44	CPUT1_LPR	OUT	True clock of differential pair 0.8V push-pull CPU outputs with integrated 33ohm series resistor. No 50 ohm resistor to GND needed.
45	GNDCPU	PWR	Ground pin for the CPU outputs
46	VDDIO_1.5	PWR	Power supply for low power differential outputs, nominal 1.5V.
47	CPUC0_LPR	OUT	Complementary clock of differential pair 0.8V push-pull CPU outputs with integrated 33ohm series resistor. No 50 ohm resistor to GND needed.
48	CPUT0_LPR	OUT	True clock of differential pair 0.8V push-pull CPU outputs with integrated 33ohm series resistor. No 50 ohm resistor to GND needed.

Functional Block Diagram

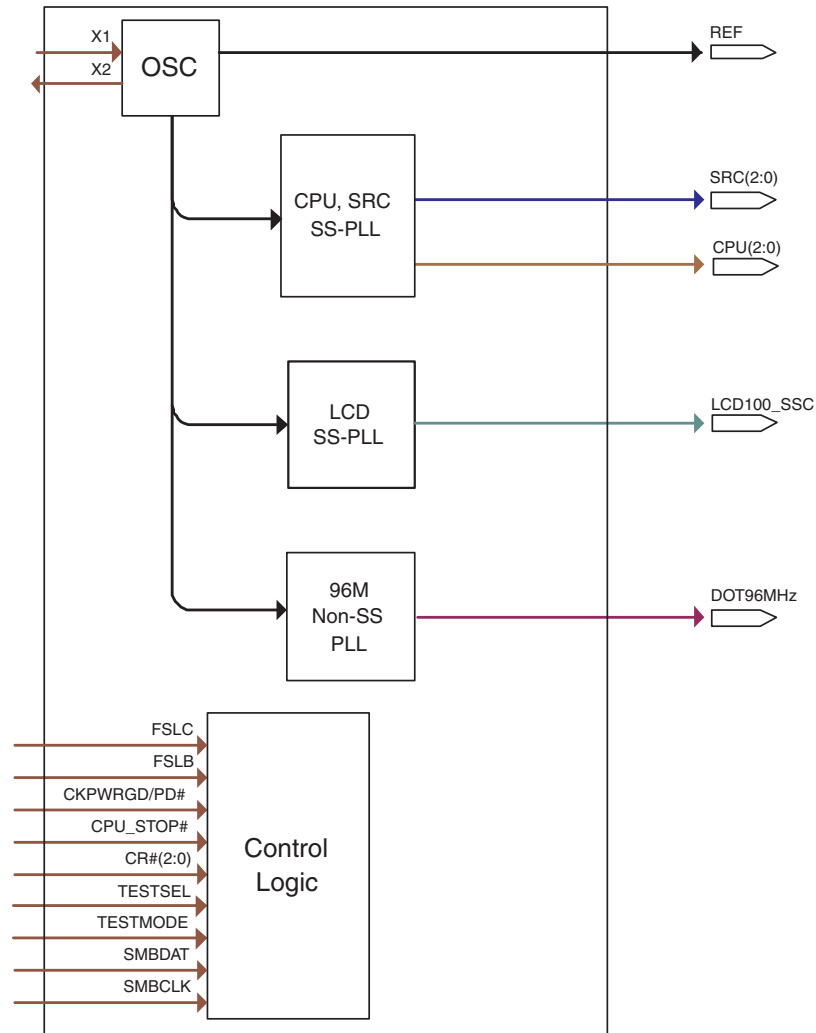

Power Groups

Pin Number		Description	
VDD	GND		
41, 46	40, 45	CPUCLK	Low power outputs
42			VDDCORE_3.3V
30	25, 33	SRCCLK	Low power outputs
29			VDDCORE_3.3V
22	19	LCDCLK	Low power outputs
23			VDDCORE_3.3V
15	18	DOT 96Mhz	Low power outputs
14			VDDCORE_3.3V
5	7		Xtal, REF

Absolute Maximum Ratings

PARAMETER	SYMBOL	CONDITIONS	MIN	MAX	UNITS	Notes
3.3V Supply Voltage	VDDxxx_3.3	Supply Voltage		3.9	V	1,2
1.5V Supply Voltage	VDDxxx_1.5	Supply Voltage		2.1	V	1,2
3.3V Input High Voltage	$V_{IH3.3}$	3.3V Inputs		VDD_3.3+0.3V	V	1,2,3
Minimum Input Voltage	V_{IL}	Any Input	GND - 0.5		V	1
Storage Temperature	T_s	-	-65	150	°C	1,2
Input ESD protection	ESD prot	Human Body Model	2000		V	1,2
		Man Machine Model	200		V	1,2

¹Guaranteed by design and characterization, not 100% tested in production.

²Operation under these conditions is neither implied, nor guaranteed.

³Maximum input voltage is not to exceed maximum VDD

Electrical Characteristics - Input/Supply/Common Output Parameters

PARAMETER	SYMBOL	CONDITIONS	MIN	MAX	UNITS	Notes
Ambient Operating Temp	$T_{ambient}$	No Airflow	0	70	°C	1
3.3V Supply Voltage	VDDxxx_3.3	3.3V +/- 5%	3.135	3.465	V	1
1.5V Supply Voltage	VDDxxx_1.5	1.5V +/- 5%	1.425	1.575	V	1
3.3V Input High Voltage	$V_{IHSE3.3}$	Single-ended inputs	2	$V_{DD} + 0.3$	V	1
3.3V Input Low Voltage	$V_{ILSE3.3}$	Single-ended inputs	$V_{SS} - 0.3$	0.8	V	1
Input Leakage Current	I_{IN}	$V_{IN} = V_{DD}, V_{IN} = GND$	-5	5	uA	1
Input Leakage Current	I_{INRES}	Inputs with pull or pull down resistors (CR# pins) $V_{IN} = V_{DD}, V_{IN} = GND$	-200	200	uA	1
Output High Voltage	V_{OHSE}	Single-ended outputs, $I_{OH} = -1mA$	2.4		V	1
Output Low Voltage	V_{OLSE}	Single-ended outputs, $I_{OL} = 1mA$		0.4	V	1
Low Threshold Input-High Voltage	V_{IHFS}	3.3V +/- 5%	0.7	1.5	V	1
Low Threshold Input-Low Voltage	V_{ILFS}	3.3V +/- 5%	$V_{SS} - 0.3$	0.35	V	1
Operating Supply Current	$I_{DD_DEFAULT}$	3.3V supply, LCDPLL off		55	mA	1
	I_{DD_LCDEN}	3.3V supply, LCDPLL enabled		60	mA	1
	I_{DD_IO}	1.5V supply, Differential IO current, all outputs enabled		50	mA	1
Power Down Current	$I_{DD_PD3.3}$	3.3V supply, Power Down Mode		1	mA	1
	I_{DD_PDIO}	1.5V IO supply, Power Down Mode		0.1	mA	1
Input Frequency	F_i	$V_{DD} = 3.3V$		15	MHz	2
Pin Inductance	L_{pin}			7	nH	1
Input Capacitance	C_{IN}	Logic Inputs	1.5	5	pF	1
	C_{OUT}	Output pin capacitance		6	pF	1
	C_{INX}	X1 & X2 pins		5	pF	1
Spread Spectrum Modulation Frequency	f_{SSMOD}	Triangular Modulation	30	33	kHz	1

AC Electrical Characteristics - Input/Common Parameters

PARAMETER	SYMBOL	CONDITIONS	MIN	MAX	UNITS	Notes
Clk Stabilization	T_{STAB}	From VDD Power-Up or de-assertion of PD# to 1st clock		1.8	ms	1
Tdrive_SRC	T_{DRSRC}	SRC output enable after PCI_STOP# de-assertion		15	ns	1
Tdrive_PD#	T_{DRPD}	Differential output enable after PD# de-assertion		300	us	1
Tdrive_CPU	T_{DRSRC}	CPU output enable after CPU_STOP# de-assertion		10	ns	1
Tfall_PD#	T_{FALL}	Fall/rise time of PD# and CPU_STOP# inputs		5	ns	1
Trise_PD#	T_{RISE}			5	ns	1

AC Electrical Characteristics - Low Power Differential Outputs

PARAMETER	SYMBOL	CONDITIONS	MIN	MAX	UNITS	NOTES
Rising Edge Slew Rate	t_{SLR}	Differential Measurement	0.5	4	V/ns	1,2
Falling Edge Slew Rate	t_{FLR}	Differential Measurement	0.5	4	V/ns	1,2
Rise/Fall Time Variation	t_{SLVAR}	Single-ended Measurement		125	ps	1
Maximum Output Voltage	V_{HIGH}	Includes overshoot		1150	mV	1
Minimum Output Voltage	V_{LOW}	Includes undershoot	-300		mV	1
Differential Voltage Swing	V_{SWING}	Differential Measurement	300		mV	1
Crossing Point Voltage	V_{XABS}	Single-ended Measurement	300	550	mV	1,3,4
Crossing Point Variation	$V_{XABSVAR}$	Single-ended Measurement		140	mV	1,3,5
Duty Cycle	D_{CYC}	Differential Measurement	45	55	%	1
CPU Jitter - Cycle to Cycle	$CPUJ_{C2C}$	Differential Measurement		85	ps	1
SRC Jitter - Cycle to Cycle	$SRCJ_{C2C}$	Differential Measurement		125	ps	1
DOT Jitter - Cycle to Cycle	$DOTJ_{C2C}$	Differential Measurement		250	ps	1
CPU[2:0] Skew	CPU_{SKEW10}	Differential Measurement		100	ps	1
SRC[2:0] Skew	SRC_{SKEW}	Differential Measurement		250	ps	1

Electrical Characteristics - REF-14.318MHz

PARAMETER	SYMBOL	CONDITIONS	MIN	MAX	UNITS	Notes
Long Accuracy	ppm	see Tperiod min-max values	-300	300	ppm	1,2
Clock period	T_{period}	14.318MHz output nominal	69.8203	69.8622	ns	2
Absolute min/max period	T_{abs}	14.318MHz output nominal	69.8203	70.86224	ns	2
Output High Voltage	V_{OH}	$I_{OH} = -1 \text{ mA}$	2.4		V	1
Output Low Voltage	V_{OL}	$I_{OL} = 1 \text{ mA}$		0.4	V	1
Output High Current	I_{OH}	$V_{OH} @ \text{MIN} = 1.0 \text{ V}$, $V_{OH} @ \text{MAX} = 3.135 \text{ V}$	-33	-33	mA	1
Output Low Current	I_{OL}	$V_{OL} @ \text{MIN} = 1.95 \text{ V}$, $V_{OL} @ \text{MAX} = 0.4 \text{ V}$	30	38	mA	1
Rising Edge Slew Rate	t_{SLR}	Measured from 0.8 to 2.0 V	1	4	V/ns	1
Falling Edge Slew Rate	t_{FLR}	Measured from 2.0 to 0.8 V	1	4	V/ns	1
Duty Cycle	d_{tt}	$V_T = 1.5 \text{ V}$	45	55	%	1
Jitter	$t_{j\text{cyc-cyc}}$	$V_T = 1.5 \text{ V}$		1000	ps	1

Electrical Characteristics - SMBus Interface

PARAMETER	SYMBOL	CONDITIONS	MIN	MAX	UNITS	Notes
SMBus Voltage	V _{DD}		2.7	3.3	V	1
Low-level Output Voltage	V _{OLSMB}	@ I _{PULLUP}		0.4	V	1
Current sinking at V _{OLSMB} = 0.4 V	I _{PULLUP}	SMB Data Pin	4		mA	1
SCLK/SDATA Clock/Data Rise Time	T _{RI2C}	(Max VIL - 0.15) to (Min VIH + 0.15)		1000	ns	1
SCLK/SDATA Clock/Data Fall Time	T _{FI2C}	(Min VIH + 0.15) to (Max VIL - 0.15)		300	ns	1
Maximum SMBus Operating Frequency	F _{SMBUS}	Block Mode		100	kHz	1

Notes on Electrical Characteristics:

- ¹Guaranteed by design and characterization, not 100% tested in production.
- ²Slew rate measured through Vswing centered around differential zero
- ³Vxabs is defined as the voltage where CLK = CLK#
- ⁴Only applies to the differential rising edge (CLK rising and CLK# falling)
- ⁵Defined as the total variation of all crossing voltages of CLK rising and CLK# falling. Matching applies to rising edge rate of CLK and falling edge of CLK#. It is measured using a +/-75mV window centered on the average cross point where CLK meets CLK#. The average cross point is used to calculate the voltage thresholds the oscilloscope is to use for the edge rate calculations.
- ⁶All Long Term Accuracy and Clock Period specifications are guaranteed assuming that REF is at 14.31818MHz
- ⁷Operation under these conditions is neither implied, nor guaranteed.
- ⁸Maximum input voltage is not to exceed maximum VDD
- ⁹See PCI Clock-to-Clock Delay Figure

Clock Periods Differential Outputs with Spread Spectrum Enabled

Measurement Window		1 Clock	1us	0.1s	0.1s	0.1s	1us	1 Clock		
Symbol		Lg-	-SSC	-ppm error	0ppm	+ ppm error	+SSC	Lg+		
Definition		Absolute Period	Short-term Average	Long-Term Average	Period	Long-Term Average	Short-term Average	Period	Units	Notes
		Minimum Absolute Period	Minimum Absolute Period	Minimum Absolute Period	Nominal	Maximum	Maximum	Maximum		
Signal Name	SRC 100	9.87400	9.99900	9.99900	10.00000	10.00100	10.05130	10.17630	ns	1,2
	CPU 100	9.91400	9.99900	9.99900	10.00000	10.00100	10.05130	10.13630	ns	1,2
	CPU 133	7.41425	7.49925	7.49925	7.50000	7.50075	7.53845	7.62345	ns	1,2
	CPU 166	5.91440	5.99940	5.99940	6.00000	6.00060	6.03076	6.11576	ns	1,2

Clock Periods Differential Outputs with Spread Spectrum Disabled

Measurement Window		1 Clock	1us	0.1s	0.1s	0.1s	1us	1 Clock		
Symbol		Lg-	-SSC	-ppm error	0ppm	+ ppm error	+SSC	Lg+		
Definition		Absolute Period	Short-term Average	Long-Term Average	Period	Long-Term Average	Short-term Average	Period	Units	Notes
		Minimum Absolute Period	Minimum Absolute Period	Minimum Absolute Period	Nominal	Maximum	Maximum	Maximum		
Signal Name	SRC 100	9.87400		9.99900	10.00000	10.00100		10.17630	ns	1,2
	CPU 100	9.91400		9.99900	10.00000	10.00100		10.13630	ns	1,2
	CPU 133	7.41425		7.49925	7.50000	7.50075		7.62345	ns	1,2
	CPU 166	5.91440		5.99940	6.00000	6.00060		6.11576	ns	1,2
	DOT 96	10.16560		10.41560	10.41670	10.41770		10.66770	ns	1,2

- ¹Guaranteed by design and characterization, not 100% tested in production.
- ²All Long Term Accuracy and Clock Period specifications are guaranteed assuming that REFOUT is at 14.31818MHz

Table 1: CPU Frequency Select Table

FS _L C ¹	FS _L B ¹	CPU MHz	SRC MHz	DOT MHz	LCD MHz	REF MHz
0	0	133.33	100.00	96.00	100.00	14.318
0	1	166.67				
1	0	100.00				
1	1	Reserved				

1. FS_LC is a low-threshold input. Please see V_{IL_FS} and V_{IH_FS} specifications in the Input/Supply/Common Output Parameters Table for correct values.

Also refer to the Test Clarification Table.

Table 2: LCD Spread Select Table (Pin 20/21)

B1b5	B1b4	B1b3	Spread %	Comment
0	0	0	-0.5%	LCD100
0	0	1	-1%	LCD100
0	1	0	-2%	LCD100
0	1	1	-2.5%	LCD100
1	0	0	+/- 0.25%	LCD100
1	0	1	+/-0.5%	LCD100
1	1	0	+/-1%	LCD100
1	1	1	+/-1.25%	LCD100

Table 3: CPU N-step Programming

CPU (MHz)	P	Default N (hex)	Fcpu
133.33	3	64	= 4MHz x N/P
166.67	3	7D	= 4MHz x N/P
100.00	4	64	= 4MHz x N/P
200.00	2	64	= 4MHz x N/P

CPU Power Management Table

PD	CPU_STOP#	SMBus Register OE	CPU	CPU#
0	1	Enable	Running	Running
1	X	Enable	Low/20K	Low
0	0	Enable	High	Low
0	X	Disable	Low/20K	Low

SRC, LCD, DOT Power Management Table

PD	CR_x#	SMBus Register OE	SRC	SRC#	DOT/LCD	DOT#/LCD#
0	0	Enable	Running	Running	Running	Running
1	X	X	Low/20K	Low	Low/20K	Low
0	1	Enable	Low/20K	Low	Running	Running
0	X	Disable	Low/20K	Low	Low/20K	Low

REF Power Management Table

PD	SMBus Register OE	REF
0	Enable	Running
1	X	Low
0	Disable	Low

General I²C serial interface information for the ICS9UMS9633B

How to Write:

- Controller (host) sends a start bit.
- Controller (host) sends the write address D2_(H)
- ICS clock will **acknowledge**
- Controller (host) sends the beginning byte location = N
- ICS clock will **acknowledge**
- Controller (host) sends the data byte count = X
- ICS clock will **acknowledge**
- Controller (host) starts sending **Byte N through Byte N + X - 1**
- ICS clock will **acknowledge** each byte **one at a time**
- Controller (host) sends a Stop bit

Index Block Write Operation			
Controller (Host)		ICS (Slave/Receiver)	
T	starT bit		
Slave Address D2 _(H)			
WR	WRite		
		ACK	
Beginning Byte = N			
		ACK	
Data Byte Count = X			
		ACK	
Beginning Byte N		X Byte	
			ACK
○			○
○			○
○			○
Byte N + X - 1			
		ACK	
P	stoP bit		

How to Read:

- Controller (host) will send start bit.
- Controller (host) sends the write address D2_(H)
- ICS clock will **acknowledge**
- Controller (host) sends the beginning byte location = N
- ICS clock will **acknowledge**
- Controller (host) will send a separate start bit.
- Controller (host) sends the read address D3_(H)
- ICS clock will **acknowledge**
- ICS clock will send the data byte count = X
- ICS clock sends **Byte N + X - 1**
- ICS clock sends **Byte 0 through byte X (if X_(H) was written to byte 0)**.
- Controller (host) will need to acknowledge each byte
- Controller (host) will send a not acknowledge bit
- Controller (host) will send a stop bit

Index Block Read Operation			
Controller (Host)		ICS (Slave/Receiver)	
T	starT bit		
Slave Address D2 _(H)			
WR	WRite		
		ACK	
Beginning Byte = N			
		ACK	
RT	Repeat starT		
Slave Address D3 _(H)			
RD	ReaD		
		ACK	
		Data Byte Count = X	
ACK			
ACK		X Byte	
			Beginning Byte N
○			○
○			○
○			○
		Byte N + X - 1	
N	Not acknowledge		
P	stoP bit		

Byte 0 PLL & Divider Enable Register

Bit(s)	Pin #	Name	Description	Type	0	1	Default
7	-	PLL1 Enable	This bit controls whether the PLL driving the CPU and SRC clocks is enabled or not.	RW	0 = Disabled	1 = Enabled	1
6	-	PLL2 Enable	This bit controls whether the PLL driving the DOT and clock is enabled or not.	RW	0 = Disabled	1 = Enabled	1
5	-	PLL3 Enable	This bit controls whether the PLL driving the LCD clock is enabled or not.	RW	0 = Disabled	1 = Enabled	1
4	-	Reserved					0
3	-	CPU Divider Enable	This bit controls whether the CPU output divider is enabled or not. NOTE: This bit should be automatically set to '0' if bit 7 is set to '0'.	RW	0 = Disabled	1 = Enabled	1
2	-	SRC Output Divider Enable	This bit controls whether the SRC output divider is enabled or not. NOTE: This bit should be automatically set to '0' if bit 7 is set to '0'.	RW	0 = Disabled	1 = Enabled	1
1	-	LCD Output Divider Enable	This bit controls whether the LCD output divider is enabled or not. NOTE: This bit should be automatically set to '0' if bit 5 is set to '0'.	RW	0 = Disabled	1 = Enabled	1
0	-	DOT Output Divider Enable	This bit controls whether the DOT output divider is enabled or not. NOTE: This bit should be automatically set to '0' if bit 6 is set to '0'.	RW	0 = Disabled	1 = Enabled	1

Byte 1 PLL SS Enable/Control Register

Bit(s)	Pin #	Name	Description	Type	0	1	Default
7		PLL1 SS Enable	This bit controls whether PLL1 has spread enabled or not. Spread spectrum for PLL1 is set at -0.5% down-spread. Note that PLL1 drives the CPU and SRC clocks.	RW	0 = Disabled	1 = Enabled	1
6		PLL3 SS Enable	This bit controls whether PLL3 has spread enabled or not. Note that PLL3 drives the SSC clock, and that the spread spectrum amount is set in bits 3-5.	RW	0 = Disabled	1 = Enabled	1
5		PLL3 FS Select	These 3 bits select the frequency of PLL3 and the SSC clock when Byte 1 Bit 6 (PLL3 Spread Spectrum Enable) is set.	RW	See Table 2: LCD Spread Select Table	0	
4	0						
3	0						
2		Reserved					0
1		Reserved					0
0		Reserved					0

Byte 2 Output Enable Register

Bit(s)	Pin #	Name	Description	Type	0	1	Default
7		CPU0 Enable	This bit controls whether the CPU[0] output buffer is enabled or not.	RW	0 = Disabled	1 = Enabled	1
6		CPU1 Enable	This bit controls whether the CPU[1] output buffer is enabled or not.	RW	0 = Disabled	1 = Enabled	1
5		CPU2 Enable	This bit controls whether the CPU[2] output buffer is enabled or not.	RW	0 = Disabled	1 = Enabled	1
4		SRC0 Enable	This bit controls whether the SRC[0] output buffer is enabled or not.	RW	0 = Disabled	1 = Enabled	1
3		SRC1 Enable	This bit controls whether the SRC[1] output buffer is enabled or not.	RW	0 = Disabled	1 = Enabled	1
2		SRC2 Enable	This bit controls whether the SRC[2] output buffer is enabled or not.	RW	0 = Disabled	1 = Enabled	1
1		DOT Enable	This bit controls whether the DOT output buffer is enabled or not.	RW	0 = Disabled	1 = Enabled	1
0		LCD100 Enable	This bit controls whether the LCD output buffer is enabled or not.	RW	0 = Disabled	1 = Enabled	1

Byte 3 Output Control Register

Bit(s)	Pin #	Name	Description	Type	0	1	Default
7		Reserved					0
6		Reserved					0
5		REF Enable	This bit controls whether the REF output buffer is enabled or not.	RW	0 = Disabled	1 = Enabled	1
4		REF Slew	These bits control the edge rate of the REF clock.	RW	00 = Slow Edge Rate 01 = Medium Edge Rate 10 = Fast Edge Rate 11 = Reserved		10
3							
2		CPU0 Stop Enable	This bit controls whether the CPU[0] output buffer is free-running or stoppable. If it is set to stoppable the CPU[0] output buffer will be disabled with the assertion of CPU_STP#.	RW	Free Running	Stoppable	0
1		CPU1 Stop Enable	This bit controls whether the CPU[1] output buffer is free-running or stoppable. If it is set to stoppable the CPU[1] output buffer will be disabled with the assertion of CPU_STP#.	RW	Free Running	Stoppable	0
0		CPU2 Stop Enable	This bit controls whether the CPU[2] output buffer is free-running or stoppable. If it is set to stoppable the CPU[2] output buffer will be disabled with the assertion of CPU_STP#.	RW	Free Running	Stoppable	0

Byte 4 CPU PLL N Register

Bit(s)	Pin #	Name	Control Function	Type	0	1	Default
Bit 7			Reserved				1
Bit 6			Reserved				1
Bit 5			Reserved				1
Bit 4			Reserved				1
Bit 3			Reserved				1
Bit 2			Reserved				1
Bit 1			Reserved				1
Bit 0		CPU N Div8	N Divider Prog bit 8	RW			0

Byte 5 CPU PLL/N Register

Bit(s)	Pin #	Name	Control Function	Type	0	1	Default
Bit 7		CPU N Div7	See Table 3: CPU N-step Programming	RW	Default depends on latched input frequency. Default for CPU = 166 is 7Dh. Default for all other frequencies is 64h.		X
Bit 6		CPU N Div6		RW		X	
Bit 5		CPU N Div5		RW		X	
Bit 4		CPU N Div4		RW		X	
Bit 3		CPU N Div3		RW		X	
Bit 2		CPU N Div2		RW		X	
Bit 1		CPU N Div1		RW		X	
Bit 0		CPU N Div0		RW		X	

Byte 6 Reserved

Bit(s)	Pin #	Name	Control Function	Type	0	1	Default
Bit 7			Reserved				1
Bit 6			Reserved				1
Bit 5			Reserved				1
Bit 4			Reserved				1
Bit 3			Reserved				0
Bit 2			Reserved				0
Bit 1			Reserved				1
Bit 0			Reserved				1

Byte 7 Reserved

Bit(s)	Pin #	Name	Control Function	Type	0	1	Default
Bit 7			Reserved				0
Bit 6			Reserved				0
Bit 5			Reserved				0
Bit 4			Reserved				0
Bit 3			Reserved				0
Bit 2			Reserved				0
Bit 1			Reserved				0
Bit 0			Reserved				0

Byte 8 Reserved

Bit(s)	Pin #	Name	Control Function	Type	0	1	Default
Bit 7			Reserved				0
Bit 6			Reserved				0
Bit 5			Reserved				0
Bit 4			Reserved				0
Bit 3			Reserved				0
Bit 2			Reserved				0
Bit 1			Reserved				0
Bit 0			Reserved				0

Byte 9 LCD100 PLL N Register

Bit(s)	Pin #	Name	Control Function	Type	0	1	Default
Bit 7		LCD100 N Div7	N Divider Programming Byte9 bit(7:0) and Byte8 bit7	R	See N-step programming formula		X
Bit 6		LCD100 N Div6		R			X
Bit 5		LCD100 N Div5		R			X
Bit 4		LCD100 N Div4		R			X
Bit 3		LCD100 N Div3		R			X
Bit 2		LCD100 N Div2		R			X
Bit 1		LCD100 N Div1		R			X
Bit 0		LCD100 N Div0		R			X

Byte 10 Status Readback Register

Bit(s)	Pin #	Name	Description	Type	0	1	Default
7	37	FSB	Frequency Select B	R	See Table 1: CPU Frequency Select Table		Latch
6	9	FSC	Frequency Select C	R			Latch
5	24	CR0# Readbk	Real time CR0# State Indicator	R	CR0# is Low	CR0# is High	X
4	28	CR1# Readbk	Real time CR1# State Indicator	R	CR1# is Low	CR1# is High	X
3	36	CR2# Readbk	Real time CR2# State Indicator	R	CR2# is Low	CR2# is High	X
2			Reserved				0
1			Reserved				0
0			Reserved				0

Byte 11 Revision ID/Vendor ID Register

Bit(s)	Pin #	Name	Description	Type	0	1	Default
7		Rev Code Bit 3	Revision ID (0 for A rev)	R	Vendor specific		X
6		Rev Code Bit 2		R			X
5		Rev Code Bit 1		R			X
4		Rev Code Bit 0		R			X
3		Vendor ID bit 3	Vendor ID	R			0
2		Vendor ID bit 2		R			0
1		Vendor ID bit 1		R			0
0		Vendor ID bit 0		R			1

Byte 12 Device ID Register

Bit(s)	Pin #	Name	Description	Type	0	1	Default
7		DEV_ID3	Device ID MSB	R			0
6		DEV_ID2	Device ID 2	R			0
5		DEV_ID1	Device ID 1	R			1
4		DEV_ID0	Device ID LSB	R			1
3			Reserved				0
2			Reserved				0
1			Reserved				0
0			Reserved				0

Byte 13 Reserved Register

Bit(s)	Pin #	Name	Control Function	Type	0	1	Default
Bit 7			Reserved				0
Bit 6			Reserved				0
Bit 5			Reserved				0
Bit 4			Reserved				0
Bit 3			Reserved				0
Bit 2			Reserved				0
Bit 1			Reserved				0
Bit 0			Reserved				0

Byte 14 Reserved Register

Bit(s)	Pin #	Name	Control Function	Type	0	1	Default
Bit 7			Reserved				0
Bit 6			Reserved				0
Bit 5			Reserved				0
Bit 4			Reserved				0
Bit 3			Reserved				0
Bit 2			Reserved				0
Bit 1			Reserved				0
Bit 0			Reserved				0

Byte 15 Byte Count Register

Bit(s)	Pin #	Name	Control Function	Type	0	1	Default
Bit 7			Reserved				0
Bit 6			Reserved				0
Bit 5		BC5	Byte Count 5	RW	Specifies Number of bytes to be read back during an SMBus read. Default is 0xF.		0
Bit 4		BC4	Byte Count 4	RW		0	
Bit 3		BC3	Byte Count 3	RW		1	
Bit 2		BC2	Byte Count 2	RW		1	
Bit 1		BC1	Byte Count 1	RW		1	
Bit 0		BC0	Byte Count LSB	RW		1	

Bytes 16:40 are reserved

Byte 41 N Program Enable Register

Bit(s)	Pin #	Name	Control Function	Type	0	1	Default
Bit 7			Reserved				0
Bit 6			Reserved				0
Bit 5			Reserved				0
Bit 4			Reserved				0
Bit 3			Reserved				0
Bit 2			Reserved				0
Bit 1		CPU N Enable	Enables CPU N programming	RW	Disabled	Enabled	0
Bit 0		LCD N Enable	Enables LCD N programming	RW	Disabled	Enabled	0

Test Clarification Table

Comments	HW		OUTPUT
	TEST_SEL HW PIN	TEST_MODE HW PIN	
	<0.35V	X	NORMAL
Power-up w/ TEST_SEL = 1 to enter test mode Cycle power to disable test mode TEST_MODE -->low Vth input TEST_MODE is a real time input	>0.7V	<0.35V	HI-Z
	>0.7V	>0.7V	REF/N

MLF Top Mark Information (9UMS9633BKLF)

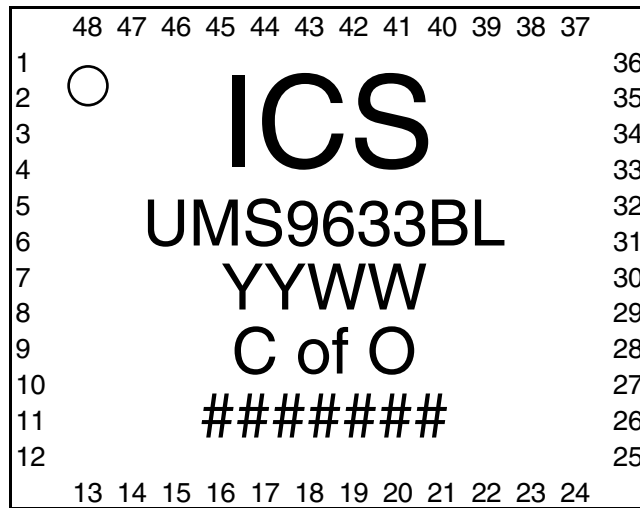

- Line 1. Company name
- Line 2. Part Number
- Line 3. YYWW = Date Code
- Line 3. Country of Origin
- Line 4. ##### = Lot Number

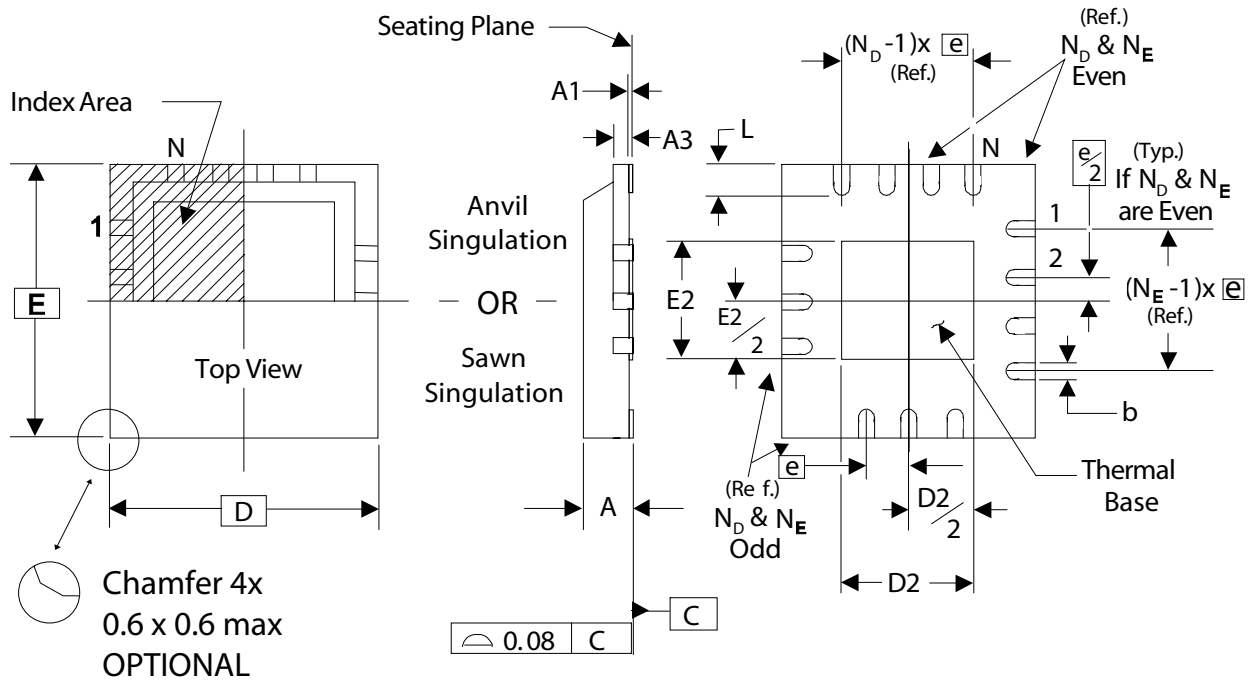

THERMALLY ENHANCED, VERY THIN, FINE PITCH
QUAD FLAT / NO LEAD PLASTIC PACKAGE

DIMENSIONS

SYMBOL	MIN.	MAX.
A	0.8	1.0
A1	0	0.05
A3	0.20 Reference	
b	0.18	0.3
e	0.40 BASIC	

DIMENSIONS

SYMBOL	48L TOLERANCE
N	48
N _D	12
N _E	12
D x E BASIC	6.00 x 6.00
D2 MIN. / MAX.	3.95 / 4.25
E2 MIN. / MAX.	3.95 / 4.25
L MIN. / MAX.	0.30 / 0.50

Ordering Information

9UMS9633BKLFT

Example:

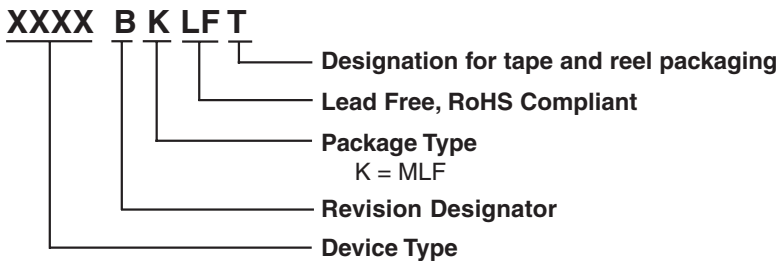

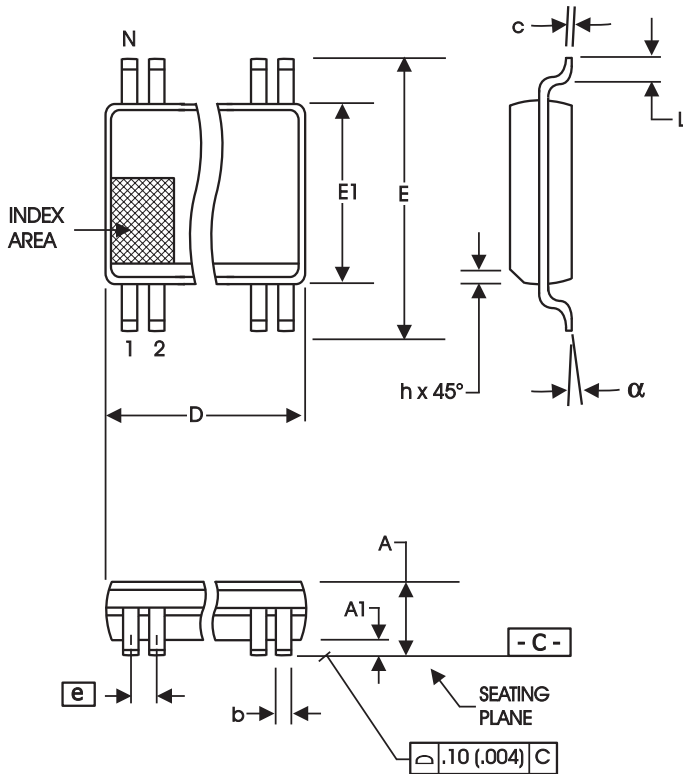

300 mil SSOP

SYMBOL	In Millimeters COMMON DIMENSIONS		In Inches COMMON DIMENSIONS	
	MIN	MAX	MIN	MAX
A	2.41	2.80	.095	.110
A1	0.20	0.40	.008	.016
b	0.20	0.34	.008	.0135
c	0.13	0.25	.005	.010
D	SEE VARIATIONS		SEE VARIATIONS	
E	10.03	10.68	.395	.420
E1	7.40	7.60	.291	.299
e	0.635 BASIC		0.025 BASIC	
h	0.38	0.64	.015	.025
L	0.50	1.02	.020	.040
N	SEE VARIATIONS		SEE VARIATIONS	
a	0°	8°	0°	8°

VARIATIONS

N	D mm.		D (inch)	
	MIN	MAX	MIN	MAX
48	15.75	16.00	.620	.630

Reference Doc.: JEDEC Publication 95, MO-118

10-0034

Ordering Information

9UMS9633BFLFT

Example:

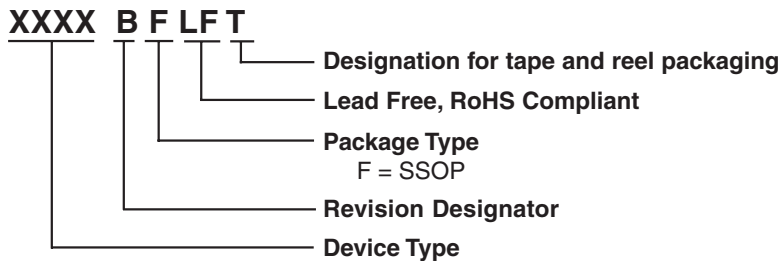

Revision History

Rev.	Issue Date	Description	Page #
0.1	12/06/07	Initial Release	-
0.2	02/27/08	1. Byte 4 default value changed to FF hex 2. Byte 6 default value changed to F3 hex.	
0.3	05/21/08	1. Corrected Reference in Byte 5 to CPU NDIV8. Should refer to Byte 4, bit 0. 2. Corrected Reference in LCD100 NDIV to only refer to Byte 9 3. Corrected headings in clock period table. 4. Added N-step programming info. 5. Corrected Byte 4 default value	
0.4	11/12/08	Removed reference to 1.5V inputs	Various
0.5	01/20/09	Updated SMBus byte 4/5; added CPU N-Step Programming table	11,15

Innovate with IDT and accelerate your future networks. Contact:

www.IDT.com

For Sales

800-345-7015
408-284-8200
Fax: 408-284-2775

For Tech Support

408-284-6578
pcclockhelp@idt.com

Corporate Headquarters

Integrated Device Technology, Inc.
6024 Silver Creek Valley Road
San Jose, CA 95138
United States
800 345 7015
+408 284 8200 (outside U.S.)

Asia Pacific and Japan

Integrated Device Technology
Singapore (1997) Pte. Ltd.
Reg. No. 199707558G
435 Orchard Road
#20-03 Wisma Atria
Singapore 238877
+65 6 887 5505

Europe

IDT Europe, Limited
Prime House
Barnett Wood Lane
Leatherhead, Surrey
United Kingdom KT22 7DE
+44 1372 363 339



www.IDT.com

© 2006 Integrated Device Technology, Inc. All rights reserved. Product specifications subject to change without notice. IDT and the IDT logo are trademarks of Integrated Device Technology, Inc. Accelerated Thinking is a service mark of Integrated Device Technology, Inc. All other brands, product names and marks are or may be trademarks or registered trademarks used to identify products or services of their respective owners.
Printed in USA