



Chipsmall Limited consists of a professional team with an average of over 10 year of expertise in the distribution of electronic components. Based in Hongkong, we have already established firm and mutual-benefit business relationships with customers from,Europe,America and south Asia,supplying obsolete and hard-to-find components to meet their specific needs.

With the principle of "Quality Parts,Customers Priority,Honest Operation,and Considerate Service",our business mainly focus on the distribution of electronic components. Line cards we deal with include Microchip,ALPS,ROHM,Xilinx,Pulse,ON,Everlight and Freescale. Main products comprise IC,Modules,Potentiometer,IC Socket,Relay,Connector.Our parts cover such applications as commercial,industrial, and automotives areas.

We are looking forward to setting up business relationship with you and hope to provide you with the best service and solution. Let us make a better world for our industry!



## Contact us

Tel: +86-755-8981 8866 Fax: +86-755-8427 6832

Email & Skype: info@chipsmall.com Web: www.chipsmall.com

Address: A1208, Overseas Decoration Building, #122 Zhenhua RD., Futian, Shenzhen, China



**40**mm sq.

# San Ace 40W



DC  
Splash Proof Fan 40mm

## General Specifications

- Material ..... Frame: Aluminum (Black coating),  
Impeller: Plastics (Flammability: UL94V-0)
- Expected Life ..... Refer to specifications (Indoor, L10:Survival rate:90% at 60°C ,  
rated voltage, and continuously run in a free air state)
- Lead Wire ..... ⊕red ⊖black (Sensor) yellow (Control) brown
- Storage Temperature ..... -30°C to +70°C (Non-condensing)

**40×40×28mm** (Mass : 70g) **IP 68** **9WL type** **High Airflow Long Life Fan**

## Specifications

The following nos. **have PWM controls and pulse sensors.**

Model No.	Rated Voltage [V]	Operating Voltage Range [V]	PWM duty cycle [Hz] [%]	Rated Current [A]	Rated Input [W]	Rated Speed [min <sup>-1</sup> ]	Max. Airflow [m <sup>3</sup> /min] [CFM]	Max. Static Pressure [Pa] [inchH <sub>2</sub> O]	SPL [dB(A)]	Operating Temperature [°C]	Expected Life [h]
<b>9WL0412P3J001</b>	12	10.8 to 13.2	100	0.52	6.24	17,500	0.63 22.2	400 1.61	51	-20 to +70	150,000/60°C
			20	0.06	0.72	3,600	0.13 4.6	16.9 0.07	20		
<b>9WL0412P3G001</b>			100	0.40	4.80	15,500	0.56 19.7	310 1.24	47		
			20	0.06	0.72	3,300	0.12 4.2	14.0 0.06	18		
<b>9WL0424P3J001</b>	24	21.6 to 26.4	100	0.26	6.24	17,500	0.63 22.2	400 1.61	51		
			20	0.04	0.96	4,000	0.14 5.1	20.9 0.08	22		
<b>9WL0424P3G001</b>			100	0.20	4.80	15,500	0.56 19.7	310 1.24	47		
			20	0.04	0.96	3,000	0.11 3.8	11.6 0.05	16		

Note: Fan does not rotate when PWM duty cycle is 0%.

※PWM Frequency : 25kHz

Other sensor specifications are available as options. Please refer to the index (p. 511).

## Dimensions (unit: mm)

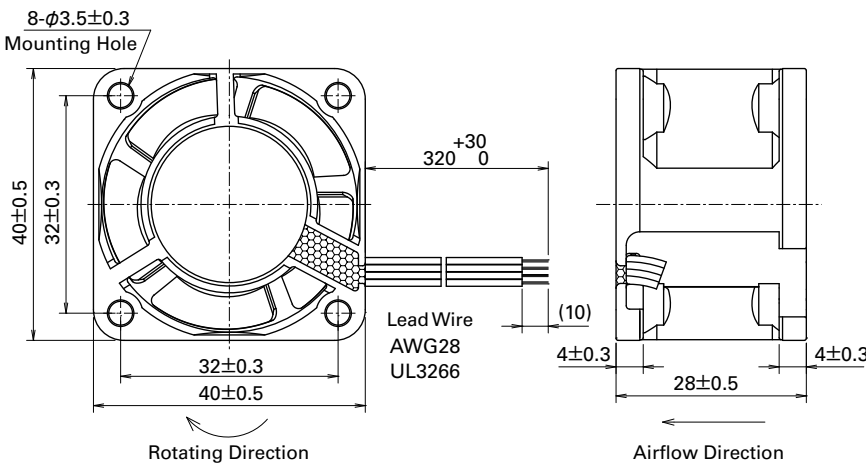

## Reference Dimensions of Mounting Holes and Vent Opening (unit: mm)

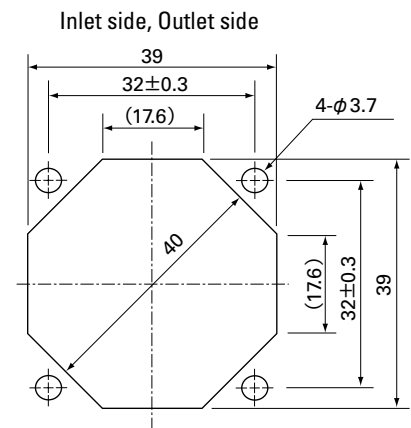

## Options (unit: mm)

### Finger Guards

Model : 109-059 Surface treatment : Nickel-chrome plating (silver)  
: 109-059H : Cation electropainting (black)

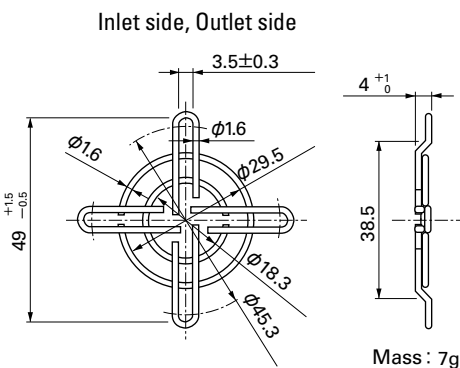

**40**mm sq.

# San Ace 40W

**40×40×28**mm [Mass : 70g]

## Airflow - Static Pressure Characteristics

### PWM Duty Cycle

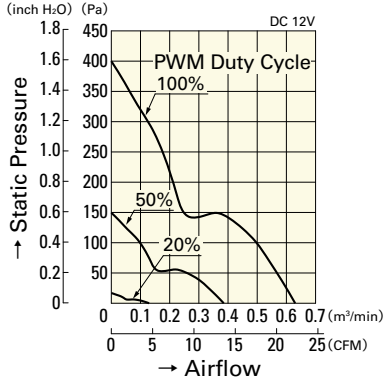

**9WL0412P3J001**

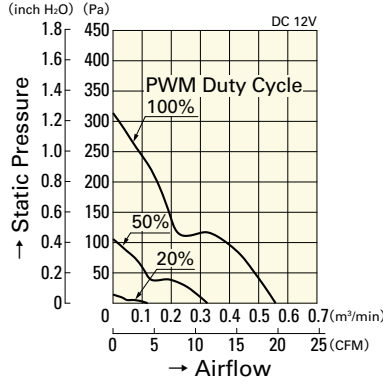

**9WL0412P3G001**

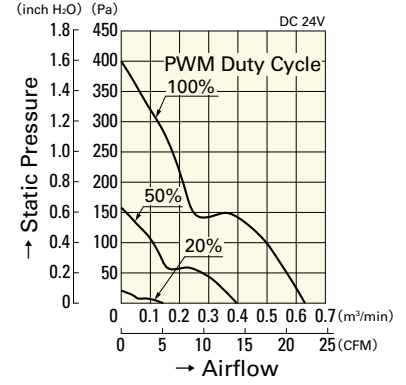

**9WL0424P3J001**

### Operating Voltage Range

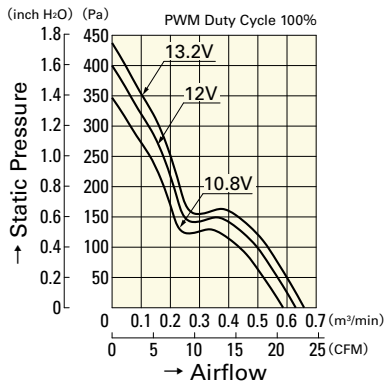

**9WL0412P3J001**

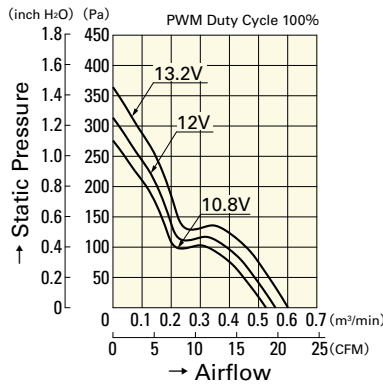

**9WL0412P3G001**

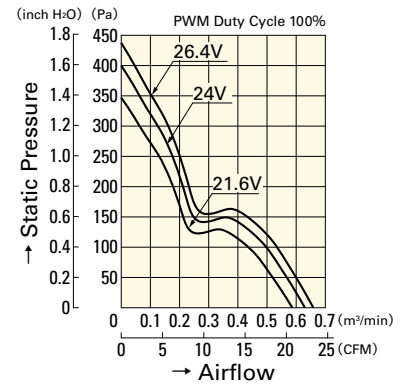

**9WL0424P3J001**

## PWM Duty - Speed Characteristics Example

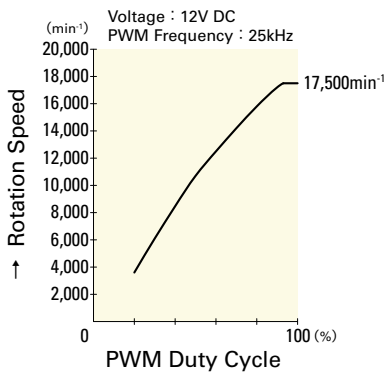

**9WL0412P3J001**

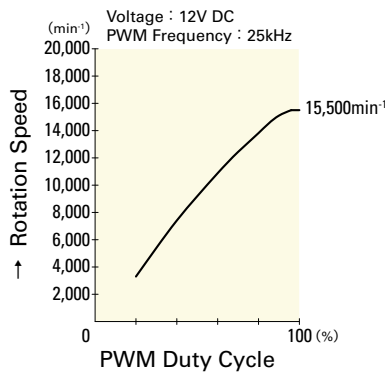

**9WL0412P3G001**

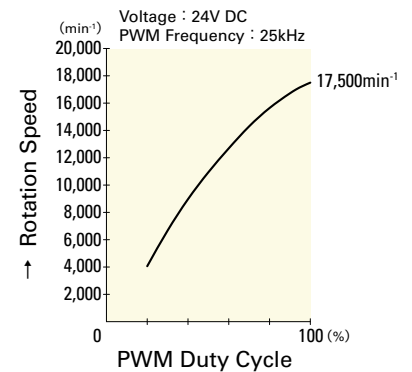

**9WL0424P3J001**



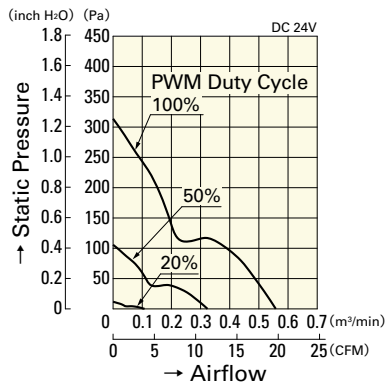

**9WL0424P3G001**

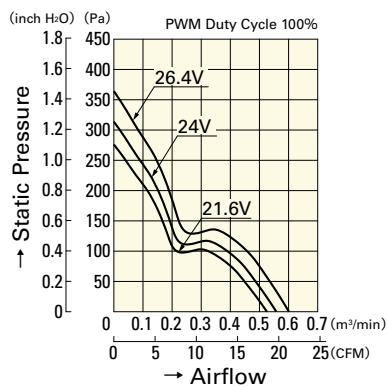

**9WL0424P3G001**

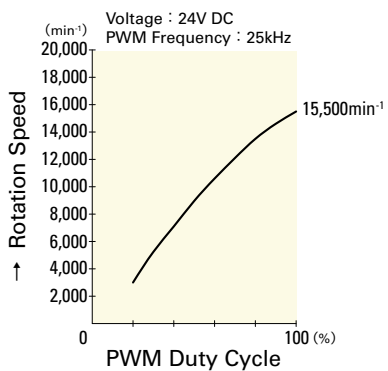

**9WL0424P3G001**