



Chipsmall Limited consists of a professional team with an average of over 10 year of expertise in the distribution of electronic components. Based in Hongkong, we have already established firm and mutual-benefit business relationships with customers from,Europe,America and south Asia,supplying obsolete and hard-to-find components to meet their specific needs.

With the principle of “Quality Parts,Customers Priority,Honest Operation,and Considerate Service”,our business mainly focus on the distribution of electronic components. Line cards we deal with include Microchip,ALPS,ROHM,Xilinx,Pulse,ON,Everlight and Freescale. Main products comprise IC,Modules,Potentiometer,IC Socket,Relay,Connector.Our parts cover such applications as commercial,industrial, and automotives areas.

We are looking forward to setting up business relationship with you and hope to provide you with the best service and solution. Let us make a better world for our industry!



Contact us

Tel: +86-755-8981 8866 Fax: +86-755-8427 6832

Email & Skype: info@chipsmall.com Web: www.chipsmall.com

Address: A1208, Overseas Decoration Building, #122 Zhenhua RD., Futian, Shenzhen, China



1 2 3 4 5 6 7

A

B

C

D

E

F

G

H

A

B

C

D

E

F

G

H

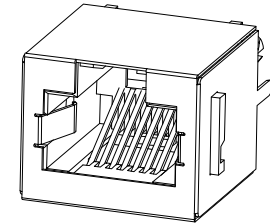
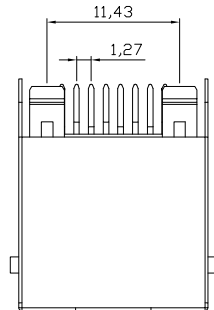

- NOTES:**
Mechanical:
 1. Housing material : High Temp. UL94V-0 , Color: Black
 2. Contact material: Phosphor Bronze t=0.35mm
 3. Contact plating: Contact area---Selective gold plating
 Tails---Tin plated all over 50u" Nickel
 4. Shell material: Copper Alloy
 5. Shell plating: Nickel plated
 6. PCB Retention Pre-solder: 1 LB min.
 7. PCB Retention Post-solder: 10 LBS min.

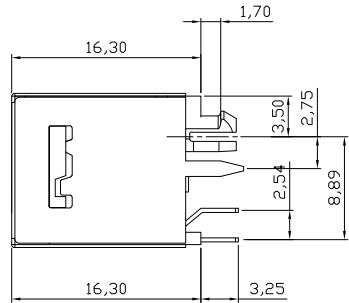
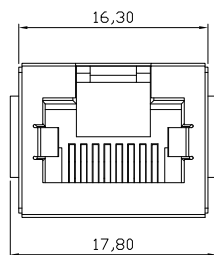
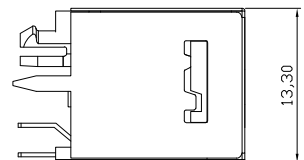
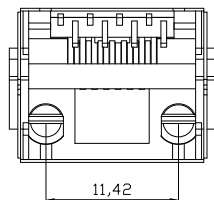

- Electrical:**
 1. Voltage Rating: 125VAC.
 2. Current Rating: 1,5AMP.
 3. Contact Resistance: 35mΩ max.
 4. Insulation Resistance: 1000MΩ min. @ 500 VDC
 5. Dielectric Strength: 1000 VAC 60Hz, 1 min.
 6. Operation: 750 cycles min.

- Environmental:**
 1. Storage: -40°C To +85°C
 2. Operation: -40°C~+85°C
 3. Wave Soldering Temperature: 255~265°C(5-10S)

Packing: Tray

Order code: A-2014-2-X-LP/FS

- Contact plating:
 1: selective 15u" gold
 2: selective 30u" gold
 3: selective 50u" gold

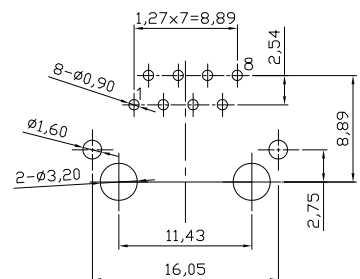

PC Board Layout
 Component Side Shown

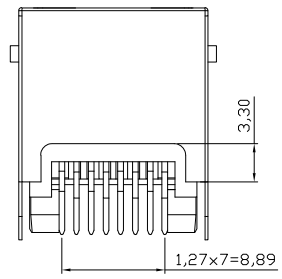

RoHS compliant
 Unit:mm

Scale	Free					Date	Name	Customer-No.
TOLERANCE					Drawn	10.05.2013	Amy	ASSMANN WSW-No. A-2014-2-X-LP/FS
X.X	±0.20				Approved	10.05.2013	Amy	
X.XX	±0.15							
X.XXX	±0.10							
DIM	TOL							Drawing-No.
								ASS 5711 CO
		①	Drawn	10.05.2013	Amy			rev00
Angle	±5°	Id.	Modification	Date	Name			Replace

1 2 3 4 5 6 7