



Chipsmall Limited consists of a professional team with an average of over 10 year of expertise in the distribution of electronic components. Based in Hongkong, we have already established firm and mutual-benefit business relationships with customers from,Europe,America and south Asia,supplying obsolete and hard-to-find components to meet their specific needs.

With the principle of "Quality Parts,Customers Priority,Honest Operation,and Considerate Service",our business mainly focus on the distribution of electronic components. Line cards we deal with include Microchip,ALPS,ROHM,Xilinx,Pulse,ON,Everlight and Freescale. Main products comprise IC,Modules,Potentiometer,IC Socket,Relay,Connector.Our parts cover such applications as commercial,industrial, and automotives areas.

We are looking forward to setting up business relationship with you and hope to provide you with the best service and solution. Let us make a better world for our industry!



## Contact us

Tel: +86-755-8981 8866 Fax: +86-755-8427 6832

Email & Skype: info@chipsmall.com Web: www.chipsmall.com

Address: A1208, Overseas Decoration Building, #122 Zhenhua RD., Futian, Shenzhen, China







**Toggle Switches, A Series, Options**

**FUNCTIONS**

The following functions available in SP or DP.

<b>01</b>	2 Positions	None indicates no mechanical position		On	None	On
<b>03</b>	3 Positions	Off indicates a mechanical position with no electrical connection.		On	Off	On
<b>05</b>	3 Positions	(On) indicates momentary action.		(On)	Off	(On)
<b>07</b>	3 Positions			(On)	Off	On
<b>08</b>	2 Positions			(On)	None	On
SPDT, connect terminals:						
DPDT, connect terminals:						

<b>11</b>	3 Positions		On	On	On
<b>13</b>	3 Positions		(On)	On	On
<b>15</b>	3 Positions		(On)	On	(On)

Functions available in DP case only

Connect terminals:

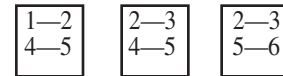

\* SP3T functions achieved with external jumper installed by customer

**WIRING DIAGRAM FOR FUNCTIONS**

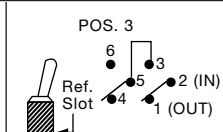
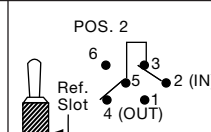
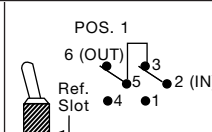
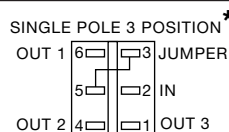
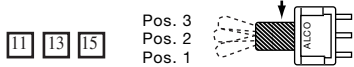

**TOGGLES**

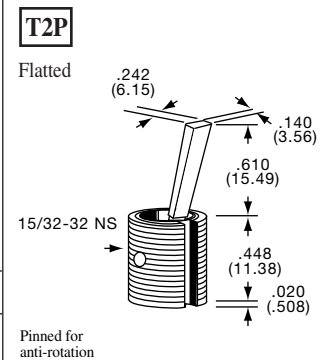
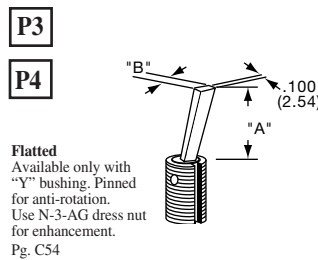
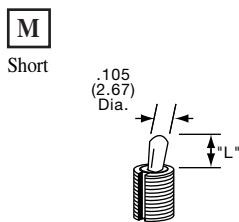
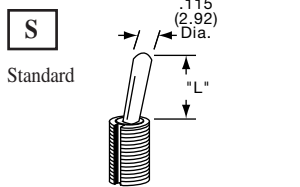

Dimension "L"	Bushing	Dimension "L"	Bushing Type	Actuator	"Dimension" "B"	
.410 (10.41)	"Y", "H", "CW"	.200 (5.08)	"Y", "H", "CW"	P3	.450 (11.43)	.200 (5.08)
.480 (12.19)	"D", "D9"	.270 (6.86)	"D", "D9"	P4	.250 (6.35)	.165 (4.19)

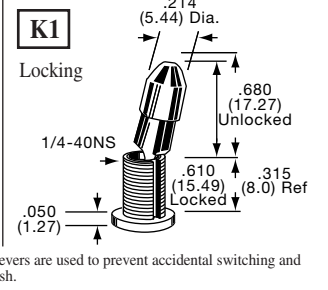
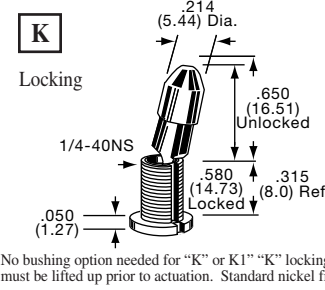
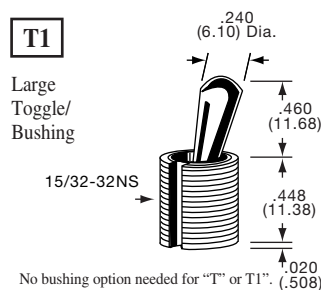
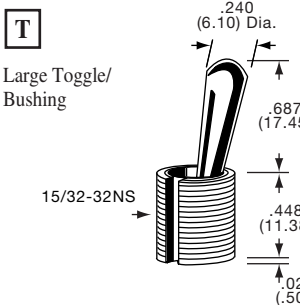

No bushing option needed for "K" or "K1" "K" locking levers are used to prevent accidental switching and must be lifted up prior to actuation. Standard nickel finish.

**Toggle Switches, A Series, Options**

**BUSHINGS**

**Y**

1/4-40 Thread  
.35" long, slotted  
(Standard)

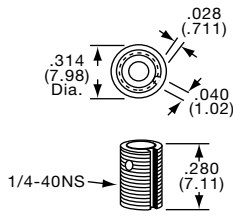

**D9**

Unthreaded  
.28" long

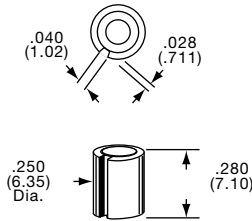

Used with  
**Z, C & W**  
terminations

**H**

1/4-40 Thread  
Flanged, .30" long

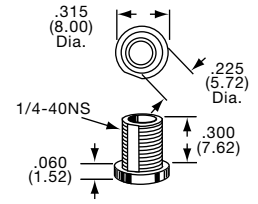

**D**

1/4-40 Thread  
.28" long, slotted

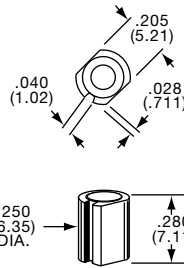
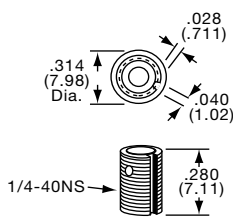

Used with  
**A, AV2, V30**  
**V80 & V90**  
terminations

**CW**

Threaded  
Splashproof

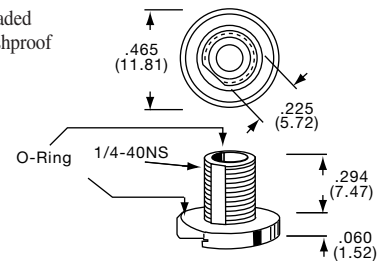

For S & M Toggles

**TERMINALS**

**Z**

Wire Lug

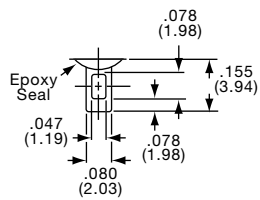

**Z3**

Quick Connect

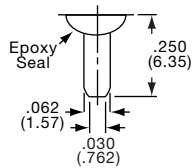

Mates with Tyco  
61454 or 60900.

**W**

Wire Wrap

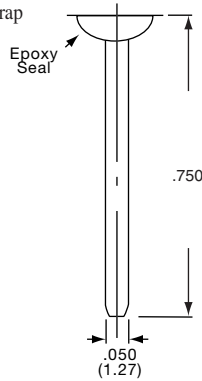

**C**

Printed Circuit

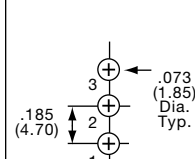
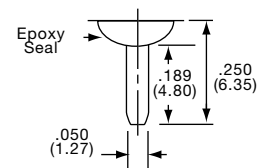

Single pole

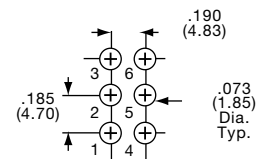

Double pole

Gemini Series

**Toggle Switches, A Series, Options**

TERMINALS

**A**

**Right Angle**  
Single Pole

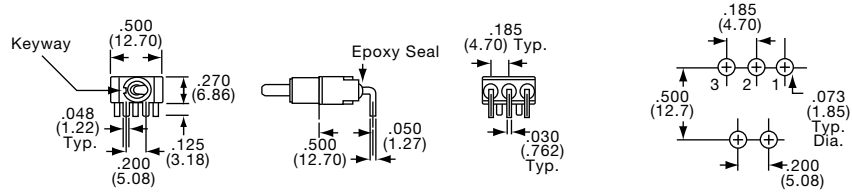

Note: Terminal numbers viewed from top of P.C. boards.

**A**

**Right Angle**  
Double Pole

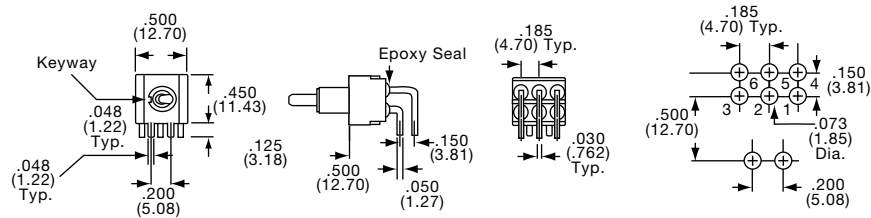

Note: Terminal numbers viewed from top of P.C. boards.

**AV2**

**Vertical Right Angle**  
Single Pole

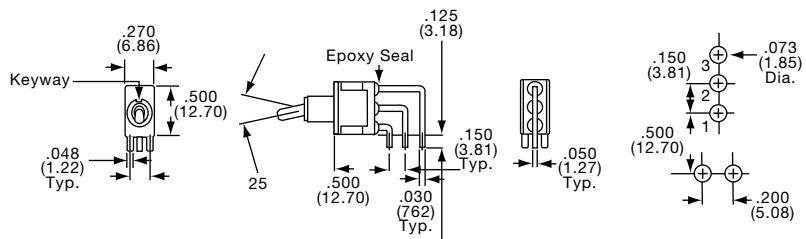

Note: Terminal numbers viewed from top of P.C. boards.

**AV2**

**Vertical Right Angle**  
Double Pole

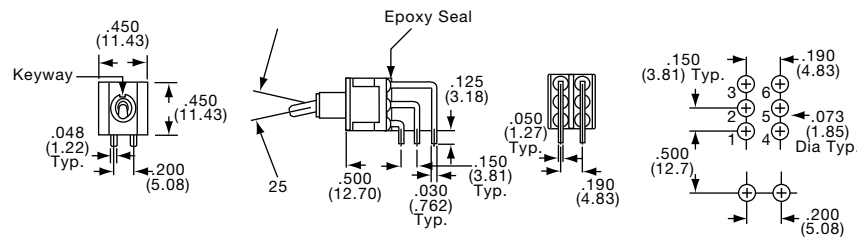

Note: Terminal numbers viewed from top of P.C. boards.

Gemini Series

**Toggle Switches, A Series, Options**

TERMINALS NOTE: Terminal numbers viewed from top of P.C. board

**V30 V40 V90**

Vertical Support Bracket  
Single Pole

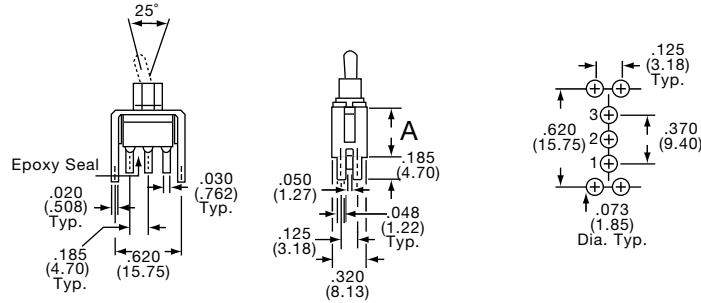

Option Code	Dim."A"
V30	.460 (11.68)
V40	.630 (16.00)
V90	1.150 (29.21)

Vertical Support Bracket  
Double Pole

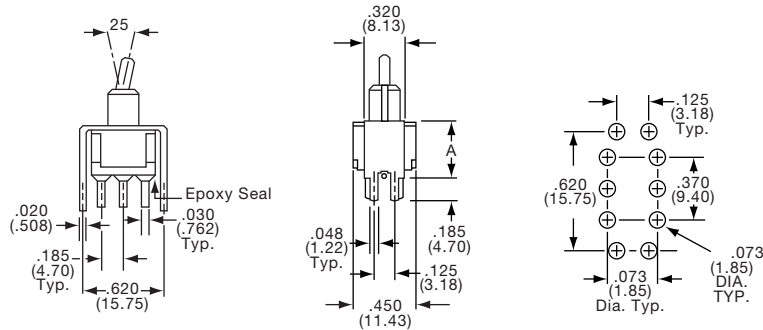

Option Code	Dim."A"
V30	.460 (11.68)
V40	.630 (16.00)
V90	1.150 (29.21)

**CONTACTS**

**B** CONTACTS: Copper alloy with gold plate, welded button.

TERMINALS: Brass with gold plate.

ELECTRICAL RATING: 0.4 VA @ 20 VAC/DC.

**Q** CONTACTS: Copper alloy with silver, welded button.

TERMINALS: Brass with tin/lead plate.

ELECTRICAL RATING: 5 A @ 125 VAC, 2 A @ 250 VAC, 2 A @ 30 VDC.

UL/CSA RATING: 5A @ 125 VAC, 3A @ 250 VAC. (Specify "UL" option code)

**G** CONTACTS: Copper alloy with gold plate over silver, welded button.

TERMINALS: Brass alloy, with gold plate.

Note: This contact option can be used for low-level or power switching. If level is above 0.4 VA @ 20 VAC/DC, the switch is rendered usable only for power switching due to arc-removal of gold plate.

UL/CSA RATING: 5A @ 125 VAC, 3A @ 250 VAC (Specify "UL" option code)

ELECTRICAL RATING: 0.4 VA @ 20 VAC/DC or 5 A @ 125 VAC, 2 A @ 250 VAC, 2 A @ 30 VDC.

Gemini Series

**Toggle Switches, A Series, Vertical, Wire Lug, Long Bat Actuator**

\* Refer to Pages C22-C26 for Additional Options \*

SEE PAGE C22 FOR PRODUCT SPECIFICATIONS

SPDT

Tyco Electronics	Alcoswitch	Type	Act. Code	P.M5			
<b>Silver Contacts</b>							
5-1437554-0	A101SYZQ	SPDT	1		On	None	On
7-1437554-7	A103SYZQ	SPDT	5		On	Off	On
9-1437554-6	A105SYZQ	SPDT	5		(On)	Off	(On)
1437555-9	A107SYZQ	SPDT	5		On	Off	(On)
2-1437555-0	A108SYZQ	SPDT	1		On	None	(On)
<b>Gold Contacts</b>							
4-1437554-9	A101SYZB	SPDT	1		On	None	On
7-1437554-6	A103SYZB	SPDT	5		On	Off	On
9-1437554-5	A105SYZB	SPDT	5		(On)	Off	(On)
	A107SYZB	SPDT	5		On	Off	(On)

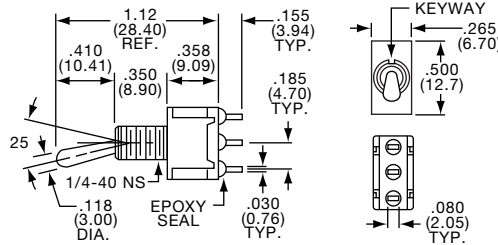

A101SYZQ

**G**  
Gemini Series

DPDT

Tyco Electronics	Alcoswitch	Type	Act. Code	P.M5			
<b>Silver Contacts</b>							
4-1437555-9	A201SYZQ	DPDT	2		On	None	On
6-1437555-2	A203SYZQ	DPDT	6		On	Off	On
7-1437555-0	A205SYZQ	DPDT	6		(On)	Off	(On)
7-1437555-6	A207SYZQ	DPDT	6		On	Off	(On)
8-1437555-5	A208SYZQ	DPDT	2		On	None	(On)
1437556-1	A211SYZQ	SP3T	11		On	On	On
1437556-4	A213SYZQ	SP3T	11		On	On	(On)
1437556-7	A215SYZQ	SP3T	11		(On)	On	(On)

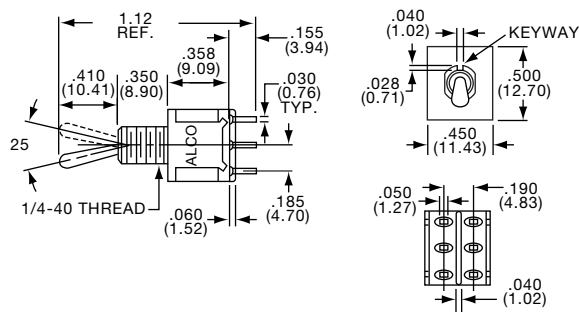

A201SYZQ

**Toggle Switches, A Series, PC Terminals, Long Bat Actuators**

\* Refer to Pages C22-C26 for Additional Options \*

SEE PAGE C22 FOR PRODUCT SPECIFICATIONS

SPDT/DPDT



A101SYAB  
Horizontal Actuation

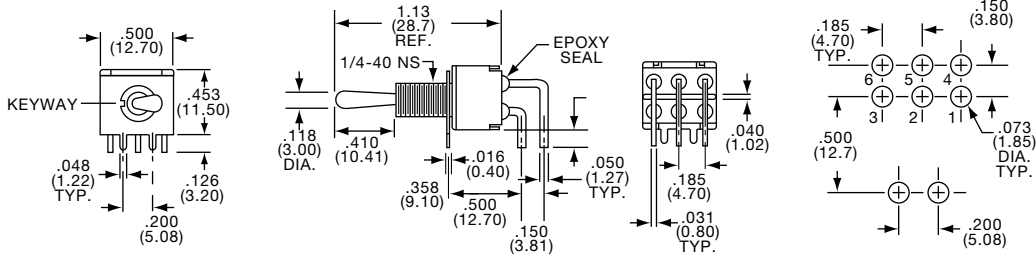
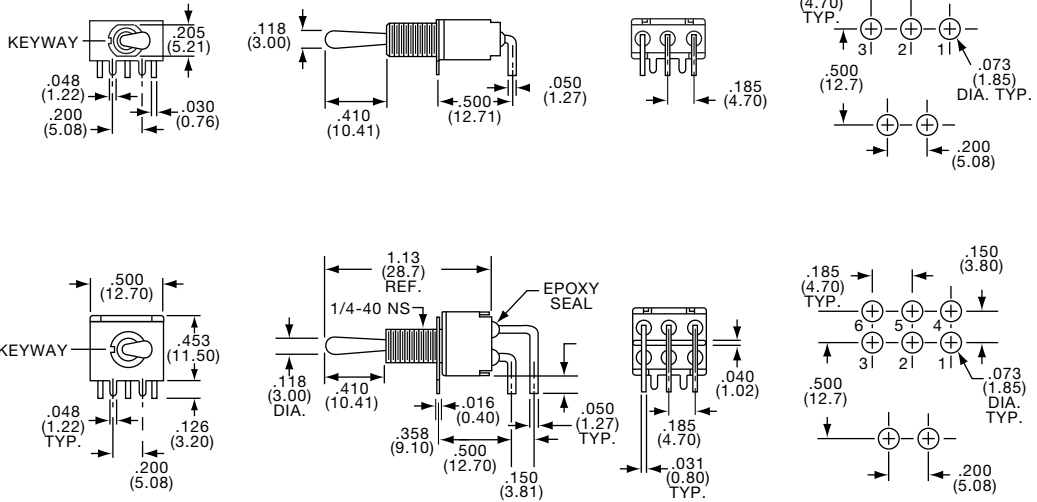

Tyco Electronics	Alcoswitch	Type	Act. Code	P.M5	↘	↓	↙
<b>Gold Contacts</b>							
4-1437554-3	A101SYAB	SPDT	1		On	None	On
	A103SYAB	SPDT	5		On	Off	On
4-1437555-3	A201SYAB	DPDT	2		On	None	On
	A208SYAB	DPDT	2		On	None	(On)

SPDT/DPDT



A101SYCB

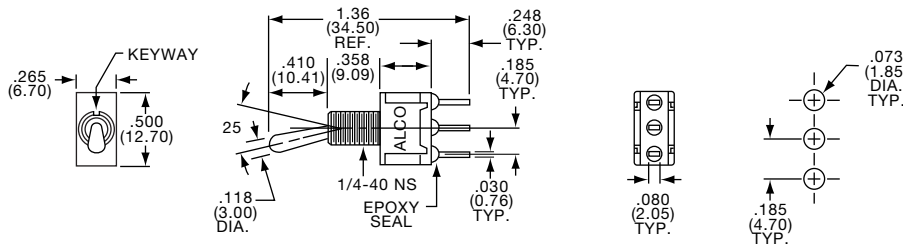

A201SYCB

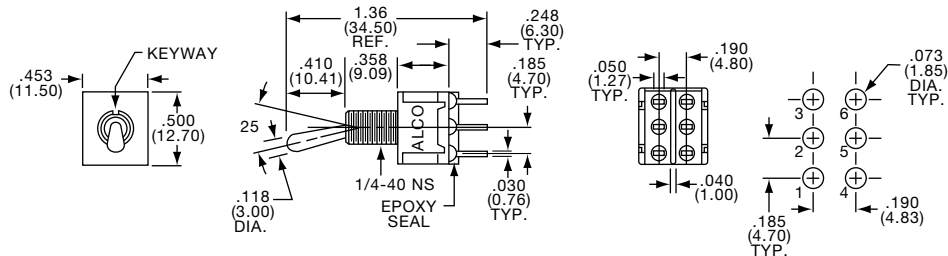

Tyco Electronics	Alcoswitch	Type	Act. Code	P.M5	↘	↓	↙
<b>Gold Contacts</b>							
4-1437554-5	A101SYCB	SPDT	1		On	None	On
7-1437554-2	A103SYCB	SPDT	5		On	Off	On
1-1437555-8	A108SYCB	SPDT	1		On	None	(On)
4-1437555-5	A201SYCB	DPDT	2		On	None	On
6-1437555-0	A203SYCB	DPDT	6		On	Off	On
8-1437555-3	A208SYCB	DPDT	2		On	None	(On)



**Toggle Switches, A Series, Wire Wrap or Wire Lug, Long Bat Actuators**

\* Refer to Pages C22-C26 for Additional Options \*

SEE PAGE C22 FOR PRODUCT SPECIFICATIONS

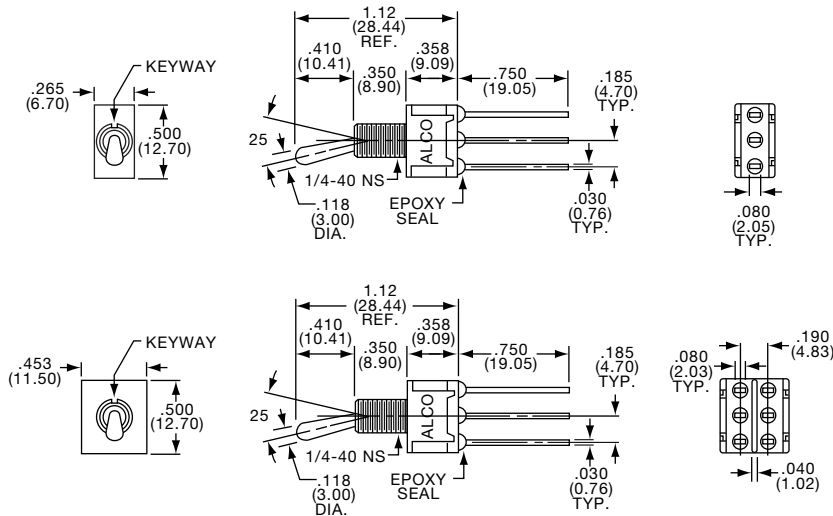

SPDT/DPDT



A101SYWQ



A201SYWQ

Tyco Electronics	Alcoswitch	Type	Act. Code	P.M5			
<b>Silver Contacts</b>							
4-1437554-8	A101SYWQ	SPDT	1	On	None	On	
7-1437554-5	A103SYWQ	SPDT	5	On	Off	On	
4-1437555-7	A201SYWQ	DPDT	2	On	None	On	
	A203SYWQ	DPDT	6	On	Off	On	

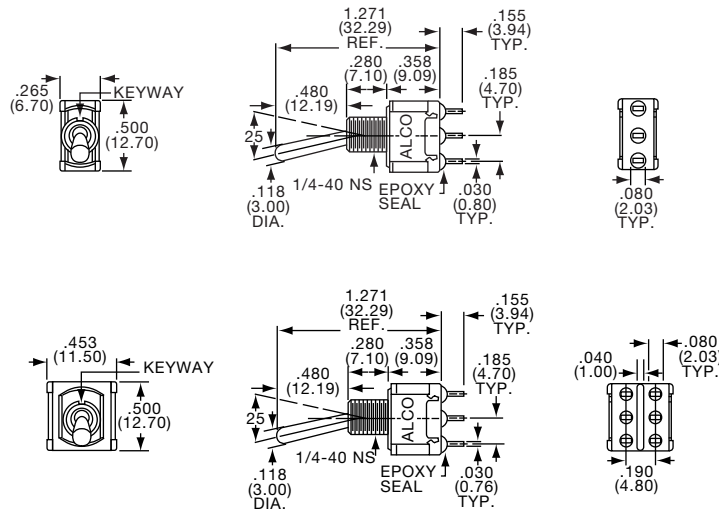

SPDT/DPDT



A101SDZQ



A201SDZQ

Tyco Electronics	Alcoswitch	Type	Act. Code	P.M5			
<b>Silver Contacts</b>							
4-1437554-0	A101SDZQ	SPDT	1	On	None	On	
6-1437554-9	A103SDZQ	SPDT	5	On	Off	On	
4-1437555-1	A201SDZQ	DPDT	2	On	None	On	
5-1437555-9	A203SDZQ	DPDT	6	On	Off	On	

**Toggle Switches, A Series, PC Tail, Straight or Right Angle, Long Bat Actuator**

\* Refer to Pages C22-C26 for Additional Options \*

SEE PAGE C22 FOR PRODUCT SPECIFICATIONS

SPDT



A101SDCQ

DPDT



A201SDCQ

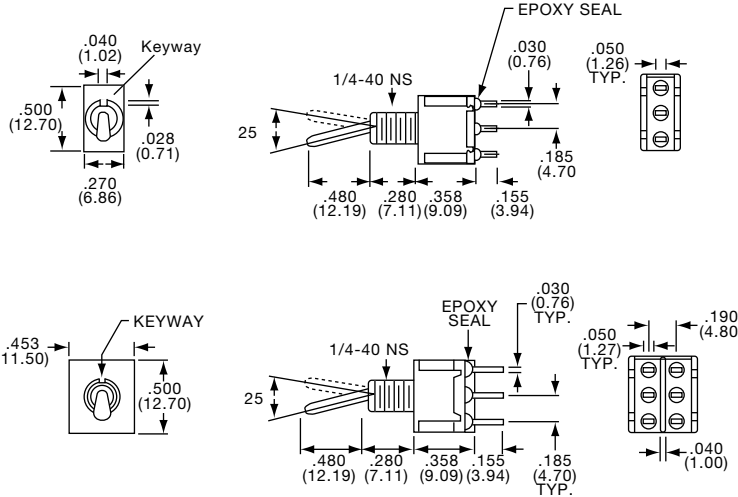

Tyco Electronics	Alcoswitch	Type	Act. Code	P.M5	↖	↓	↗
<b>Silver Contacts</b>							
3-1437554-9	A101SDCQ	SPDT	1		On	None	On
6-1437554-8	A103SDCQ	SPDT	5		On	Off	On
1571670-1	A201SDCQ	DPDT	2		On	None	On
	A203SDCQ	DPDT	6		On	Off	On
	A208SDCQ	DPDT	2		On	None	(On)

SPDT/DPDT



A101SD9AQ

Horizontal Actuation

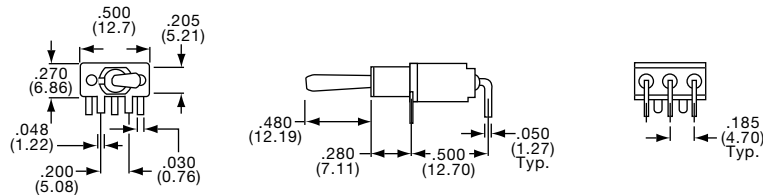

A201SD9AQ

Horizontal Actuation

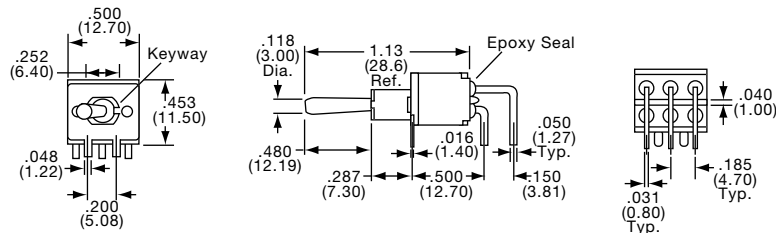

Tyco Electronics	Alcoswitch	Tyco Electronics	Alcoswitch	Type	Act. Code	P. M5	↖	↓	↗	
<b>Silver Contacts</b>										
3-1437554-4	A101SD9AQ	<b>Gold Contacts</b>		3-1437554-3	A101SD9AB	SPDT	1	On	None	On
6-1437554-4	A103SD9AQ	A103SD9AB	SPDT	5	On	Off	On			
1-1437555-6	A108SD9AQ	A108SD9AB	SPDT	1	On	None	(On)			
3-1437555-8	A201SD9AQ	A201SD9AB	DPDT	2	On	None	On			
8-1437555-1	A208SD9AQ	A208SD9AB	DPDT	2	On	None	(On)			

**Toggle Switches, A Series, Vertical, Right Angle, Long Bat Actuator**

\* Refer to Pages C22-C26 for Additional Options \*

SEE PAGE C22 FOR PRODUCT SPECIFICATIONS

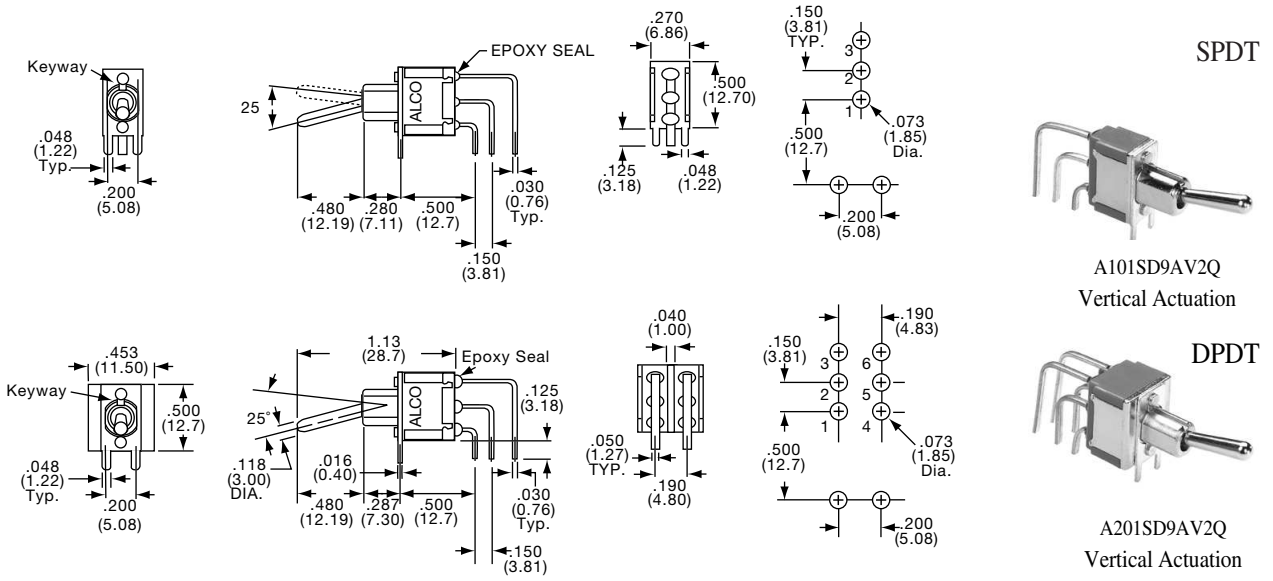

Tyco Electronics	Alcoswitch	Type	Act. Code	P.M5	On	None	On	Tyco Electronics	Alcoswitch	Type	Act. Code	P.M5	On	None	On
<b>Silver Contacts</b>															
3-1437554-6	A101SD9AV2Q	SPDT	1		On	None	On	3-1437555-9	A201SD9AV2Q	DPDT	2		On	None	On
6-1437554-6	A103SD9AV2Q	SPDT	5		On	Off	On	5-1437555-8	A203SD9AV2Q	DPDT	6		On	Off	On
								8-1437555-2	A208SD9AV2Q	DPDT	2		On	None	(On)

**Toggle Switches, A Series, Wire Lug, Locking Toggle**

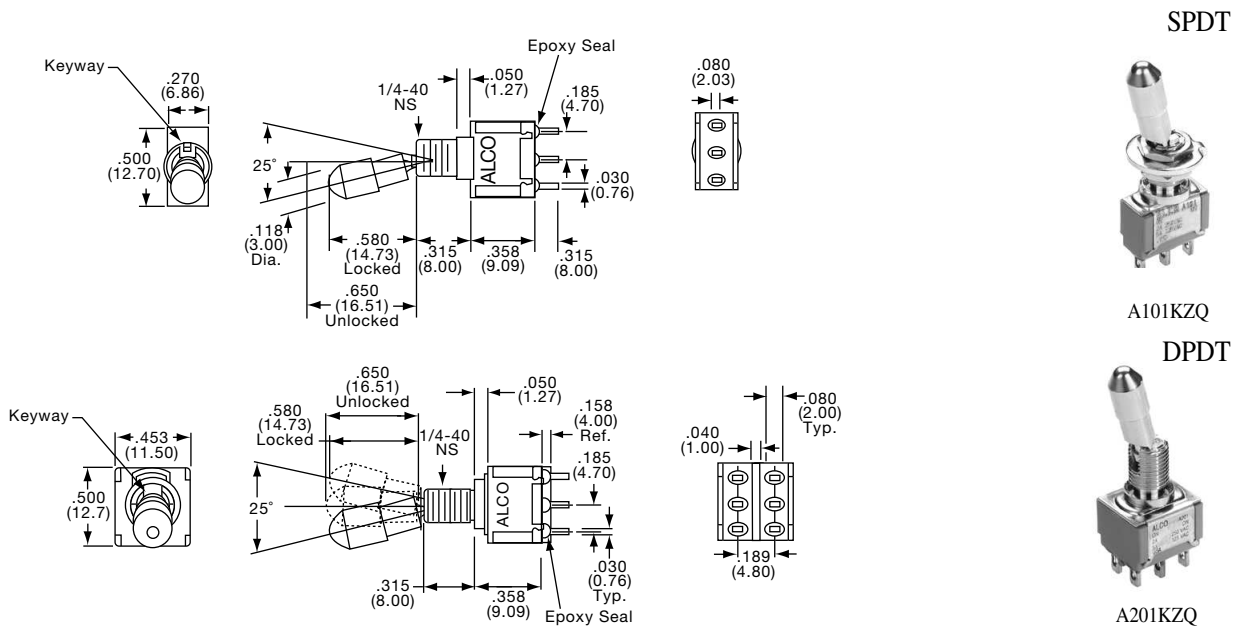

Tyco Electronics	Alcoswitch	Type	Act. Code	P.M5	On	None	On	Tyco Electronics	Alcoswitch	Type	Act. Code	P.M5	On	None	On
<b>Silver Contacts</b>															
1437554-9	A101KZQ	SPDT	1		On	None	On	<b>Silver Contacts</b>							
5-1437554-8	A103KZQ	SPDT	5		On	Off	On	2-1437555-5	A201KZQ	DPDT	2		On	None	On
								5-1437555-3	A203KZQ	DPDT	6		On	Off	On
								6-1437555-5	A205KZQ	DPDT	6		(On)	Off	(On)
								8-1437555-8	A211KZB	SP3T	11		On	On	On

\* Refer to Pages C22-C26 for Additional Options \*

**Toggle Switches, A Series, Right Angle, Short Bat Actuators**

SEE PAGE C22 FOR PRODUCT SPECIFICATIONS

**SPDT**



**A101MD9AQ**  
Horizontal Actuation

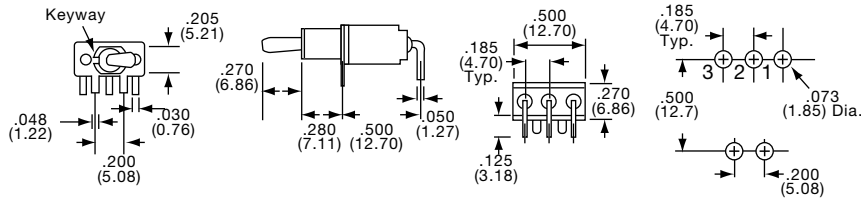

Tyco Electronics	Alcoswitch	Tyco Electronics	Alcoswitch	Type	Act. Code	P. M5			
<b>Silver Contacts</b>		<b>Gold Contacts</b>							
1-1437554-6	A101MD9AQ	1-1437554-4	A101MD9AB	SPDT	1		On	None	On
6-1437554-1	A103MD9AQ	5-1437554-9	A103MD9AB	SPDT	5		On	Off	On
	A108MD9AQ	1-1437555-2	A108MD9AB	SPDT	1		On	None	(On)

**DPDT**



**A201MD9AQ**  
Horizontal Actuation

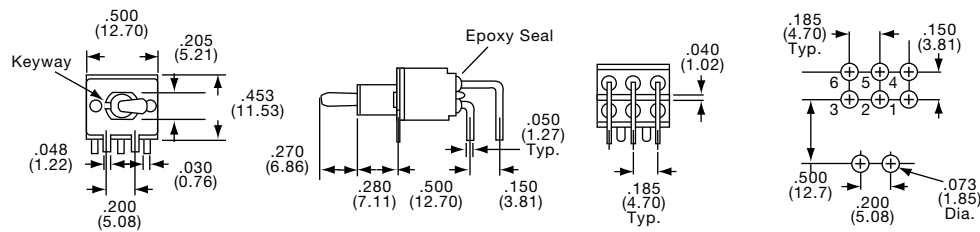

Tyco Electronics	Alcoswitch	Tyco Electronics	Alcoswitch	Type	Act. Code	P. M5			
<b>Silver Contacts</b>		<b>Gold Contacts</b>							
2-1437555-8	A201MD9AQ	2-1437555-7	A201MD9AB	DPDT	2		On	None	On
		5-1437555-4	A203MD9AB	DPDT	6		On	Off	On

**SPDT**



**A101MD9AV2Q**  
Vertical Actuation

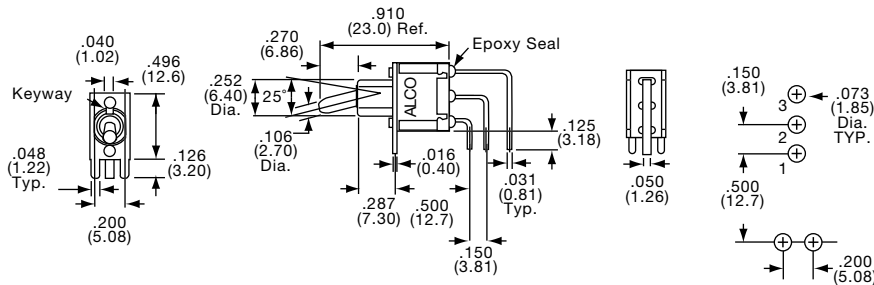

Tyco Electronics	Alcoswitch	Tyco Electronics	Alcoswitch	Type	Act. Code	P. M5			
<b>Silver Contacts</b>		<b>Gold Contacts</b>							
1-1437554-9	A101MD9AV2Q	1-1437554-7	A101MD9AV2B	SPDT	1		On	None	On
	A103MD9AV2Q	6-1437554-2	A103MD9AV2B	SPDT	5		On	Off	On
	A108MD9AV2Q			SPDT	1		On	None	(On)

**DPDT**



**A201MD9AV2AQ**  
Vertical Actuation

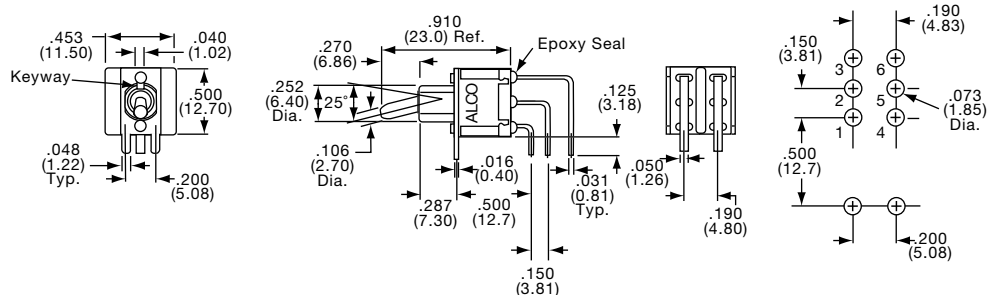

Tyco Electronics	Alcoswitch	Tyco Electronics	Alcoswitch	Type	Act. Code	P. M5			
<b>Silver Contacts</b>		<b>Gold Contacts</b>							
3-1437555-0	A201MD9AV2Q	2-1437555-9	A201MD9AV2B	DPDT	2		On	None	On
	A203MD9AV2Q		A203MD9AV2B	DPDT	6		On	Off	On
	A208MD9AV2Q		A208MD9AV2B	DPDT	2		On	None	(On)



**Toggle Switches, A Series, Vertical, Wire Lug, Flat or Long Bat Actuator**

\* Refer to Pages C22-C26 for Additional Options \*

SEE PAGE C22 FOR PRODUCT SPECIFICATIONS

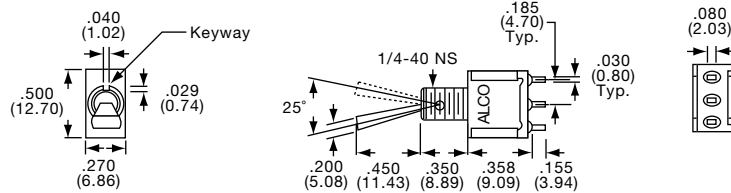

SPDT



A101P3YZQ

Tyco Electronics	Alcoswitch	Type	Act. Code	P.M5			
<b>Silver Contacts</b>							
2-1437554-9	A101P3YZQ	SPDT	1		On	None	On
6-1437554-3	A103P3YZQ	SPDT	5		On	Off	On
8-1437554-7	A105P3YZQ	SPDT	5		(On)	Off	(On)
1437555-5	A107P3YZQ	SPDT	5		On	Off	(On)
1-1437555-5	A108P3YZQ	SPDT	1		On	None	(On)

**C**  
Gemini Series

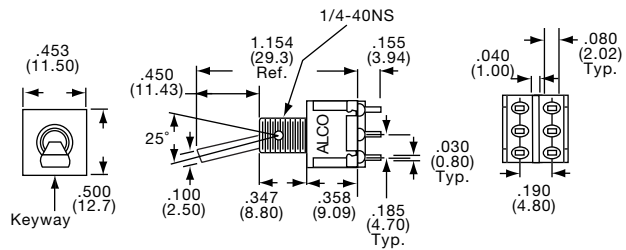

DPDT



A201P3YZQ

Tyco Electronics	Alcoswitch	Type	Act. Code	P.M5			
<b>Silver Contacts</b>							
3-1437555-6	A201P3YZQ	DPDT	2		On	None	On
5-1437555-6	A203P3YZQ	DPDT	6		On	Off	On
6-1437555-6	A205P3YZQ	DPDT	6		(On)	Off	(On)
7-1437555-3	A207P3YZQ	DPDT	6		On	Off	(On)
8-1437555-0	A208P3YZQ	DPDT	2		On	None	(On)
9-1436555-3	A211P3YZQ	SP3T	11		On	On	On
	A215P3YZQ	SP3T	11		(On)	On	(On)

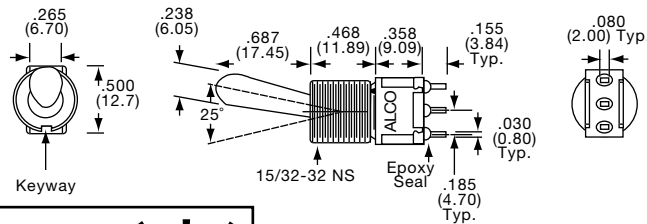

SPDT



A101TZQ

Tyco Electronics	Alcoswitch	Type	Act. Code	P.M5			
<b>Silver Contacts</b>							
5-1437554-6	A101TZQ	SPDT	1		On	None	On
8-1437554-0	A103TZQ	SPDT	5		On	Off	On

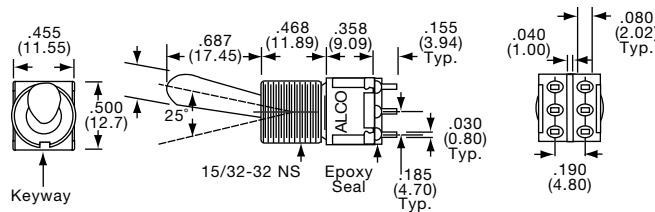

DPDT



A201TZQ

Tyco Electronics	Alcoswitch	Type	Act. Code	P.M5			
<b>Silver Contacts</b>							
5-1437555-2	A201TZQ	DPDT	2		On	None	On
6-1437555-4	A203TZQ	DPDT	6		On	Off	On
	A211TZQ	SP3T	11		On	On	On

**Toggle Switches, A Series, Wire Lug, 15/32 Bushing, Short Bat Actuator**

\* Refer to Pages C22-C26 for Additional Options \*

SEE PAGE C22 FOR PRODUCT SPECIFICATIONS

SPDT



A103T1ZQ

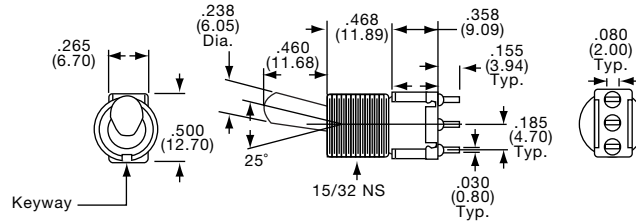

Tyco Electronics	Alcoswitch	Type	Act. Code	P.M5	↘	↓	↙
<b>Silver Contacts</b>							
5-1437554-4	A101T1ZQ	SPDT	1		On	None	On
7-1437554-9	A103T1ZQ	SPDT	5		On	Off	On
9-1437554-8	A105T1ZQ	SPDT	5		(On)	Off	(On)
	A108T1ZQ	SPDT	1		On	None	(On)

DPDT



A201T1ZQ

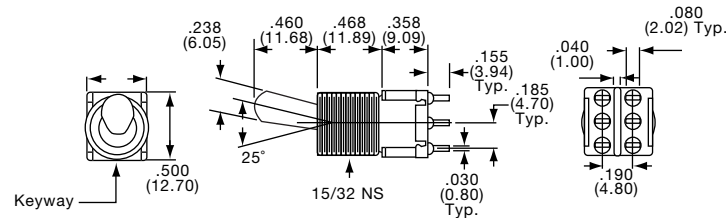

Tyco Electronics	Alcoswitch	Type	Act. Code	P.M5	↘	↓	↙
<b>Silver Contacts</b>							
5-1437555-0	A201T1ZQ	DPDT	2		On	None	On
6-1437555-3	A203T1ZQ	DPDT	6		On	Off	On
7-1437555-1	A205T1ZQ	DPDT	6		(On)	Off	(On)
7-1437555-7	A207T1ZQ	DPDT	6		On	Off	(On)
8-1437555-6	A208T1ZQ	DPDT	2		On	None	(On)
1437556-2	A211T1ZQ	SP3T	11		On	On	On