



Chipsmall Limited consists of a professional team with an average of over 10 year of expertise in the distribution of electronic components. Based in Hongkong, we have already established firm and mutual-benefit business relationships with customers from,Europe,America and south Asia,supplying obsolete and hard-to-find components to meet their specific needs.

With the principle of “Quality Parts,Customers Priority,Honest Operation,and Considerate Service”,our business mainly focus on the distribution of electronic components. Line cards we deal with include Microchip,ALPS,ROHM,Xilinx,Pulse,ON,Everlight and Freescale. Main products comprise IC,Modules,Potentiometer,IC Socket,Relay,Connector.Our parts cover such applications as commercial,industrial, and automotives areas.

We are looking forward to setting up business relationship with you and hope to provide you with the best service and solution. Let us make a better world for our industry!



## Contact us

Tel: +86-755-8981 8866 Fax: +86-755-8427 6832

Email & Skype: info@chipsmall.com Web: www.chipsmall.com

Address: A1208, Overseas Decoration Building, #122 Zhenhua RD., Futian, Shenzhen, China



### Key-Type Selector Switch

### A22K

Install in 22-mm dia. or 25-mm dia.  
Panel Cutout

- Locking lever ensures easy mounting and removal of switch unit
- Increase wiring efficiency and decrease mounting depth with three-row mounting of switch unit contact blocks
- Finger-safe contacts
- Use optional 25-mm dia. ring to install in 25-mm dia. panel cutouts
- Install using either round, forked crimp terminals, or ferrules
- IP65 oil resistant: EN60947-5-1

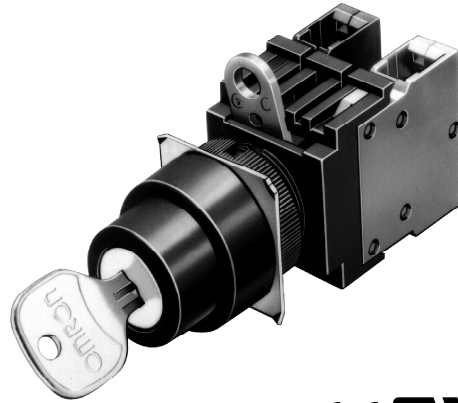

This product was manufactured at OMRON Izumo. OMRON Izumo has obtained approvals from international certification bodies for its quality system and environmental control system.

## Ordering Information

### ■ CONSTRUCTION

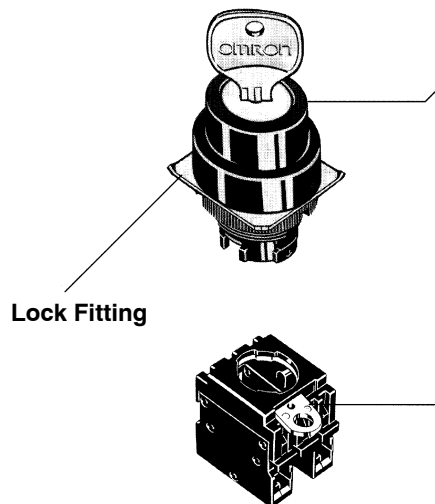

#### Operational Unit

Number of Positions

- 2 Positions/3 Positions

#### Key Release Position

2 Positions



3 Positions



#### Switch Unit

- **Contacts**

SPST-NO, SPST-NC, SPST-NO + SPST-NC, DPST-NO, DPST-NC

## ■ PART NUMBER LEGEND

Shipped as a set which includes the Operational Unit and Switch Unit with contact blocks.

A22K- <sup>1</sup>- <sup>2</sup>

### 1 Number of Positions/Reset Method

| Code | Positions   | Reset method  | Key release position |
|------|-------------|---------------|----------------------|
| 2ML  | 2 positions | Maintained    | Left                 |
| 2M   |             |               | Left and right       |
| 2AL  |             | Spring return | Left                 |
| 3ML  | 3 positions | Maintained    | Left                 |
| 3M   |             |               | Left and right       |
| 3MC  |             |               | Center               |
| 3AC  |             | Spring return | Center               |











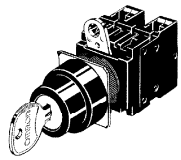



















### 2 Contacts

| Code | Description       |
|------|-------------------|
| 10   | SPST-NO (*)       |
| 01   | SPST-NC (*)       |
| 11   | SPST-NO + SPST-NC |
| 20   | DPST-NO           |
| 02   | DPST-NC           |

Note: \* for models with 2 Positions

Note: SPST= Single Pole, Single Throw  
DPST= Double Pole, Single Throw

## ■ KEY-TYPE SELECTOR SWITCH

| Appearance  | Positions   | Operator type  | Contacts  | Key release position  | Color of Operational Unit | Part number  |  |             |
|---|-------------|--|---|---|---------------------------|--|--|-------------|
| Key-type selector switch<br> | 2 positions | Maintained<br>    | SPST-NO   |                 | Black                     | A22K-2ML-10  |  |             |
|   |             |  |   |                 |                           | A22K-2M-10   |  |             |
|   |             |  | SPST-NC   |                 |                           | A22K-2ML-01  |  |             |
|   |             |  |   |                 |                           | A22K-2M-01   |  |             |
|   |             |  | SPST-NO + SPST-NC   |                 |                           | A22K-2ML-11  |  |             |
|   |             |  |   |                 |                           | A22K-2M-11   |  |             |
|   |             |  | DPST-NO   |                 |                           | A22K-2ML-20  |  |             |
|   |             |                  |   | A22K-2M-20  |                           |  |  |             |
|   |             | DPST-NC  |                 | A22K-2ML-02   |                           |  |  |             |
|   |             |  |                 | A22K-2M-02  |                           |  |  |             |
|   |             | Spring return<br> | 2 positions   | Maintained<br> |                           | SPST-NO  |  | A22K-2AL-10 |
|   |             |  |   |   |                           | SPST-NC  |  | A22K-2AL-01 |
|   |             |  |   |   |                           | SPST-NO + SPST-NC  |  | A22K-2AL-11 |
|   |             |  |   |   |                           | DPST-NO  |  | A22K-2AL-20 |
|   | DPST-NC     |  |   |   | A22K-2AL-02               |  |  |             |
|   | 3 positions | Maintained<br>  | SPST-NO + SPST-NC   |               | Black                     | A22K-3ML-11  |  |             |
|   |             |  |   |               |                           | A22K-3M-11   |  |             |
|   |             |  |   |               |                           | A22K-3MC-11  |  |             |
|   |             |  | DPST-NO   |               |                           | A22K-3ML-20  |  |             |
|   |             |  |   |               |                           | A22K-3M-20   |  |             |
|   |             |  |   |               |                           | A22K-3MC-20  |  |             |
|   |             |  | DPST-NC   |               |                           | A22K-3ML-02  |  |             |
|   |             |                |   | A22K-3M-02  |                           |  |  |             |
|   |             |                |   | A22K-3MC-02   |                           |  |  |             |
|                           |             | A22K-3AC-11  |   |   |                           |  |  |             |
| Spring return<br>          |             | 3 positions  | Maintained<br> | SPST-NO + SPST-NC   |                           |  | A22K-3AC-11  |             |
|   |             |  |   | DPST-NO   |                           |  | A22K-3AC-20  |             |
|   |             |  |   | DPST-NC   |                           |  | A22K-3AC-02  |             |

# Dimensions

Unit: mm (inch)

## KEY-TYPE SELECTOR SWITCH

A22K

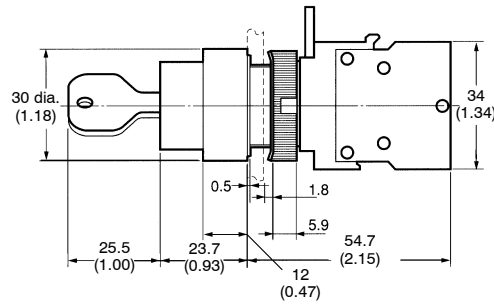
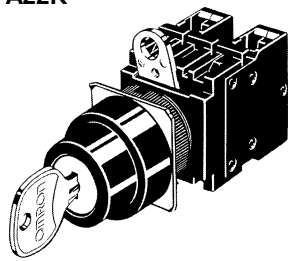

## TERMINAL ARRANGEMENT

### Terminal Arrangement (Bottom View)

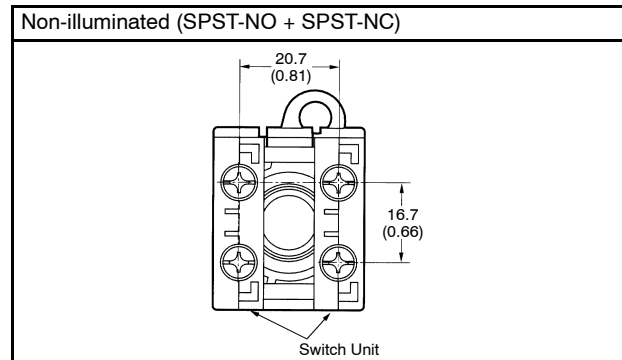

## TERMINAL CONNECTION

| Type            | Terminal connection |
|-----------------|---------------------|
| Non-illuminated | <p>Bottom view</p>  |

Note: The above terminal connection diagrams are examples for SPST-NO + SPST-NC.

## PANEL CUTOUT DIMENSIONS

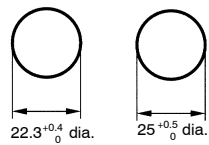













Note: When applying a coating such as paint to a panel, the dimensions should be those after the application of the coating.













A lock fitting is provided as a standard item.

## ■ CONTACT CONFIGURATION

### 2-Position Type

| Knob position   | SPST-NO   | SPST-NC   | SPST-NO + SPST-NC   | DPST-NO   | DPST-NC   |
|---|---|---|---|---|---|
|  |  |  |  |  |  |
|  |  |  |  |  |  |

### 3-Position Type

| Knob position   | SPST-NO + SPST-NC   | DPST-NO  | DPST-NC   |
|---|---|--|---|
|  |  |  |  |
|  |  |  |  |
|  |  |  |  |

Note: For additional specifications and information refer to the *Common to all assemblies* section at the end of this publication.

**NOTE: DIMENSIONS SHOWN ARE IN MILLIMETERS. To convert millimeters to inches divide by 25.4.**

**OMRON**<sup>®</sup>

**OMRON ELECTRONICS LLC**

One East Commerce Drive  
Schaumburg, IL 60173

**1-800-55-OMRON**

**OMRON ON-LINE**

Global - <http://www.omron.com>  
USA - <http://www.omron.com/oei>  
Canada - <http://www.omron.com/oci>

**OMRON CANADA, INC.**

885 Milner Avenue  
Scarborough, Ontario M1B 5V8

**416-286-6465**