



Chipsmall Limited consists of a professional team with an average of over 10 year of expertise in the distribution of electronic components. Based in Hongkong, we have already established firm and mutual-benefit business relationships with customers from,Europe,America and south Asia,supplying obsolete and hard-to-find components to meet their specific needs.

With the principle of "Quality Parts,Customers Priority,Honest Operation,and Considerate Service",our business mainly focus on the distribution of electronic components. Line cards we deal with include Microchip,ALPS,ROHM,Xilinx,Pulse,ON,Everlight and Freescale. Main products comprise IC,Modules,Potentiometer,IC Socket,Relay,Connector.Our parts cover such applications as commercial,industrial, and automotives areas.

We are looking forward to setting up business relationship with you and hope to provide you with the best service and solution. Let us make a better world for our industry!



## Contact us

Tel: +86-755-8981 8866 Fax: +86-755-8427 6832

Email & Skype: info@chipsmall.com Web: www.chipsmall.com

Address: A1208, Overseas Decoration Building, #122 Zhenhua RD., Futian, Shenzhen, China



## Micropower Ultra-Sensitive Hall-Effect Switches

### Features and Benefits

- Micropower operation
- Operate with north or south pole
- 2.4 to 5.5 V battery operation
- Chopper stabilized
  - Superior temperature stability
  - Extremely low switchpoint drift
  - Insensitive to physical stress
- High ESD protection
- Solid state reliability
- Small size
- Easily assembly into applications due to magnetic pole independence

### Packages



3 lead ultramini SIP  
(suffix UA)

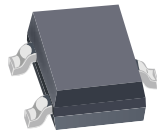

3 pin surface mount  
SOT23-W (suffix LH)

Not to scale

### Description

The A3213 and A3214 integrated circuits are ultra-sensitive, pole independent Hall-effect switches with a latched digital output. They are especially suited for operation in battery-operated, hand-held equipment such as cell and cordless telephones and palmtop computers. A 2.4 to 5.5 V operation and a unique clocking scheme reduce the average operating power requirements: the A3213 to 825  $\mu\text{W}$ , the A3214 to 14  $\mu\text{W}$  (typical, at 2.75 V). Except for operating duty cycle and average operating current, the A3213 and A3214 are identical.

Unlike other Hall-effect switches, either a north or south pole of sufficient strength will turn the output on; in the absence of a magnetic field, the output is off. The polarity independence and minimal power requirement allows these devices to easily replace reed switches for superior reliability and ease of manufacturing, while eliminating the requirement for signal conditioning.

Improved stability is made possible through chopper stabilization (dynamic offset cancellation), which reduces the residual offset voltage normally caused by device overmolding, temperature dependencies, and thermal stress.

These devices include, on a single silicon chip, a Hall-voltage

*Continued on the next page...*

### Functional Block Diagram

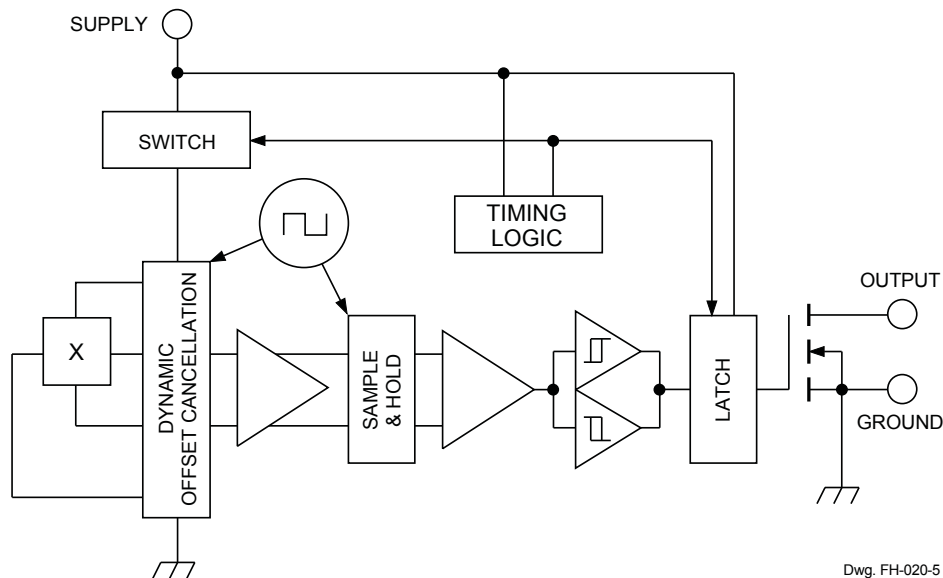

Dwg. FH-020-5

## Description (continued)

generator, small-signal amplifier, chopper stabilization, a latch, and a MOSFET output. Advanced BiCMOS processing is used to take advantage of low-voltage and low-power requirements, component matching, very low input-offset errors, and small component geometries.

Devices are rated for operation over a temperature range of  $-40^{\circ}\text{C}$  to  $85^{\circ}\text{C}$  or  $-40^{\circ}\text{C}$  to  $150^{\circ}\text{C}$ . Two package styles provide a magnetically optimized package for most applications. 'LH' is a

miniature low-profile surface-mount package, 'UA' is a three-lead SIP for through-hole mounting. Each package is lead (Pb) free (suffix, -T), with a 100% matte tin plated leadframe.

## Product Selection Guide

Part Number	Mounting	Packing*	Ambient*, $T_A$ ( $^{\circ}\text{C}$ )	DC (%)	$I_{DD(AVG)}$ (typ) ( $\mu\text{A}$ )
A3213ELHLT-T	LH package Surface Mount	7-in. reel 3000 pieces/reel	-40 to 85	25	309
A3213EUA-T	UA package SIP through hole	Bulk 500 pieces/bag			
A3213LUA-T	UA package SIP through hole	Bulk 500 pieces/bag	-40 to 150		
A3214ELHLT-T	LH package Surface Mount	7-in. reel 3000 pieces/reel	-40 to 85	0.10	6
A3214EUA-T	UA package SIP through hole	Bulk 500 pieces/bag			



\*Contact Allegro for additional packing and operating temperature range options

## Absolute Maximum Ratings

Characteristic	Symbol	Notes	Rating	Units
Supply Voltage	$V_{DD}$		6	V
Magnetic Flux Density	B		Unlimited	G
Output Off Voltage	$V_{OUT}$		6	V
Output Current	$I_{OUT}$		1	mA
Operating Ambient Temperature	$T_A$	Range E	-40 to 85	$^{\circ}\text{C}$
		Range L	-40 to 150	$^{\circ}\text{C}$
Maximum Junction Temperature	$T_J(\text{max})$		165	$^{\circ}\text{C}$
Storage Temperature	$T_{stg}$		-65 to 170	$^{\circ}\text{C}$

**Pin-out Diagrams**

Number		Name	Description
LH	UA		
1	1	VDD	Input power supply; tie to GND with bypass capacitor
3	2	GND	Ground
2	3	VOUT	Output signal

LH Package

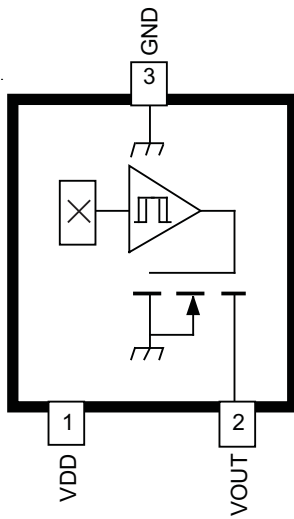

UA Package

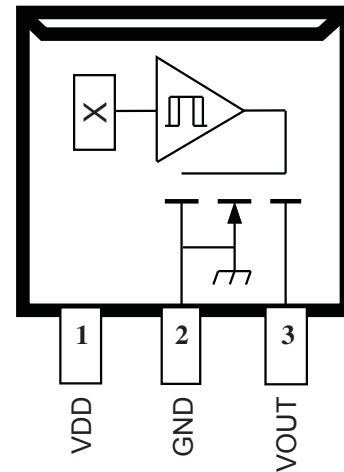

**ELECTRICAL CHARACTERISTICS** valid over operating voltage and temperature range, unless otherwise noted

Characteristic	Symbol	Test Conditions	Min.	Typ. <sup>1</sup>	Max.	Units
Supply Voltage Range	$V_{DD}$	Operating <sup>1)</sup>	2.4	3.0	5.5	V
Output Leakage Current	$I_{OFF}$	$V_{OUT} = 5.5 \text{ V}$ , $B_{RPN} < B < B_{RPS}$	–	<1.0	1.0	$\mu\text{A}$
Output On Voltage	$V_{OUT(ON)}$	Output on, $I_{OUT} = 1 \text{ mA}$ , $V_{DD} = 3.0 \text{ V}$	–	100	300	mV
Awake Time	$t_{awake}$		–	60	90	$\mu\text{s}$
Period	$t_{period}$	A3213	–	240	360	$\mu\text{s}$
		A3214, $T_A = 25^\circ\text{C}$ , $V_{DD} = 3 \text{ V}$	–	60	90	ms
Duty Cycle	DC	A3213	–	25	–	%
		A3214	–	0.10	–	%
Chopping Frequency	$f_C$		–	340	–	kHz
Supply Current	$I_{DD(EN)}$	Chip awake (enabled)	–	–	2.0	mA
	$I_{DD(DIS)}$	Chip asleep (disabled)	–	–	8.0	$\mu\text{A}$
	$I_{DD(AVG)}$	A3213	–	309	850	$\mu\text{A}$
		A3214	–	6	22	$\mu\text{A}$

<sup>1</sup>Typical Data is at  $T_A = 25^\circ\text{C}$  and  $V_{DD} = 3.0 \text{ V}$  and is for design information only.

<sup>2</sup>Operate and release points will vary with supply voltage.  $B_{OPx}$  = operate point (output turns ON);  $B_{RPx}$  = release point (output turns OFF).

**MAGNETIC CHARACTERISTICS<sup>1</sup>** valid over operating voltage and temperature range, unless otherwise noted

Characteristic	Symbol <sup>2</sup>	Test Conditions	Min.	Typ. <sup>3</sup>	Max.	Units <sup>4</sup>
Operate Points	$B_{OPS}$	South pole to branded side	–	42	70	G
	$B_{OPN}$	North pole to branded side	–70	–48	–	G
Release Points	$B_{RPS}$	South pole to branded side	10	32	–	G
	$B_{RPN}$	North pole to branded side	–	–38	–10	G
Hysteresis	$B_{hys}$	$ B_{OPx} - B_{RPx} $	–	10	–	G

<sup>1</sup>As used here, negative flux densities are defined as less than zero (algebraic convention) and -50 G is less than +10 G.

<sup>2</sup> $B_{OPx}$  = operate point (output turns ON);  $B_{RPx}$  = release point (output turns OFF).

<sup>3</sup>Typical Data is at  $T_A = 25^\circ\text{C}$  and  $V_{DD} = 3.0 \text{ V}$  and is for design information only.

<sup>4</sup>1 gauss (G) is exactly equal to 0.1 millitesla (mT).

**THERMAL CHARACTERISTICS may require derating at maximum conditions, see application information**

Characteristic	Symbol	Test Conditions*	Value	Units
Package Thermal Resistance	$R_{\theta JA}$	Package LH, 1-layer PCB with copper limited to solder pads	228	$^{\circ}\text{C}/\text{W}$
		Package LH, 2-layer PCB with 0.463 in. <sup>2</sup> of copper area each side connected by thermal vias	110	$^{\circ}\text{C}/\text{W}$
		Package UA, 1-layer PCB with copper limited to solder pads	165	$^{\circ}\text{C}/\text{W}$

\*Additional thermal information available on Allegro website.

**Power Derating Curve**

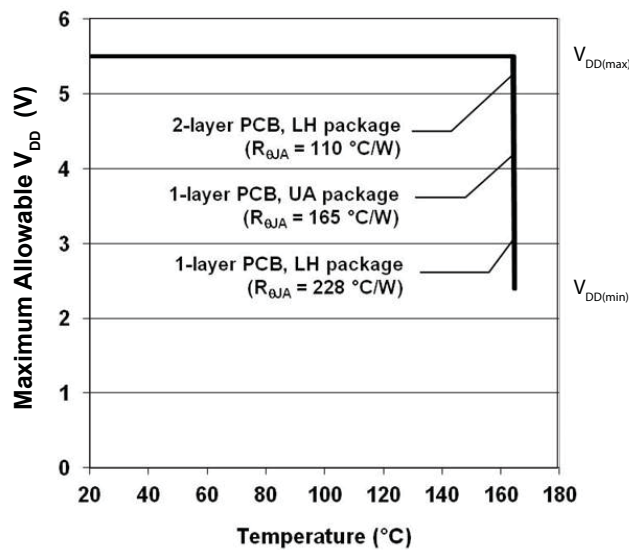

**Power Dissipation versus Ambient Temperature**

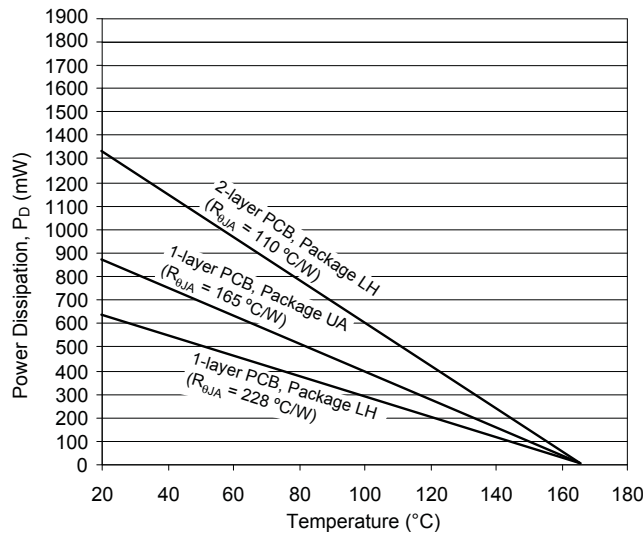

## Typical Operating Characteristics

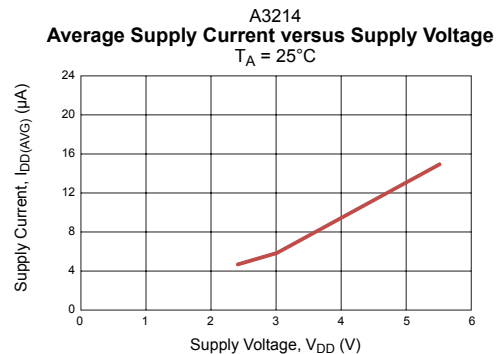
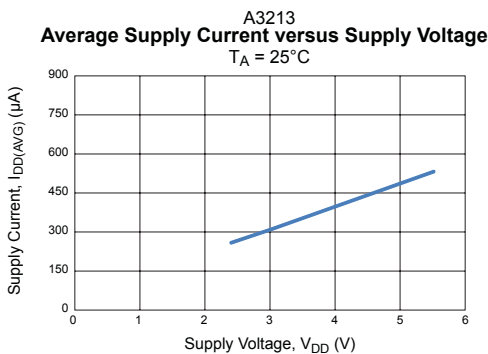
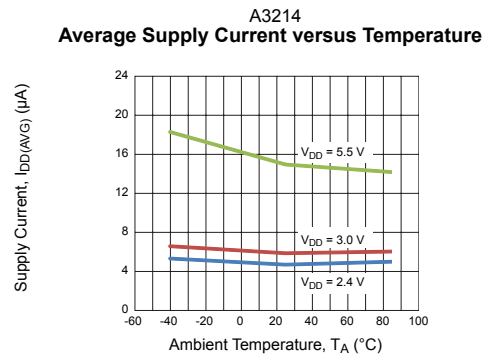
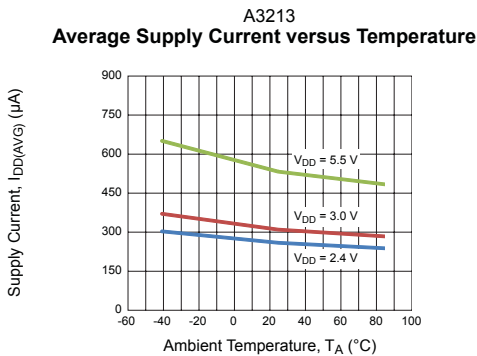
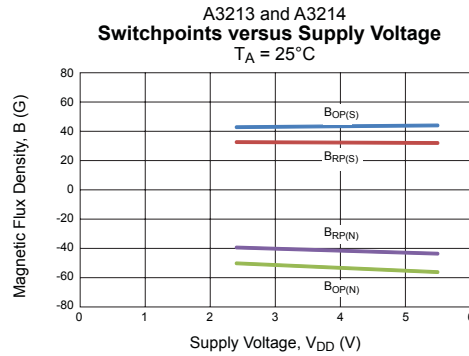
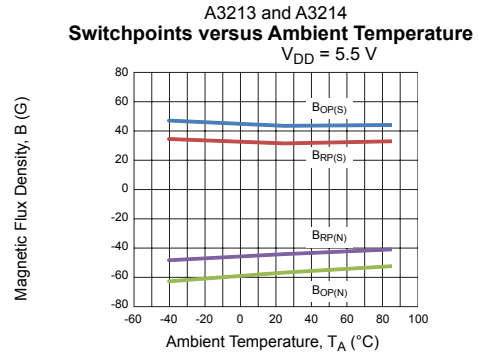
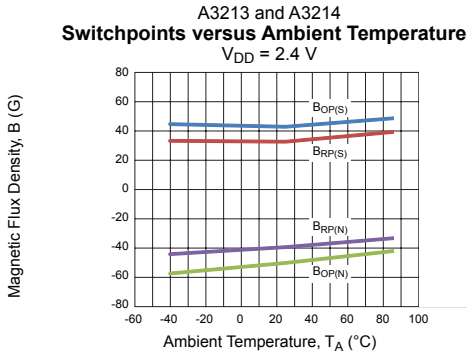

**FUNCTIONAL DESCRIPTION**

**Low Average Power.** Internal timing circuitry activates the IC for 60  $\mu$ s and deactivates it for the remainder of the period (240  $\mu$ s (typ) for the A3213 and 60 ms (typ) for the A3214). A short "awake" time allows for stabilization prior to the sampling and data latching on the falling edge of the timing pulse. The output during the "sleep" time is latched in the last sampled state. The supply current is not affected by the output state.

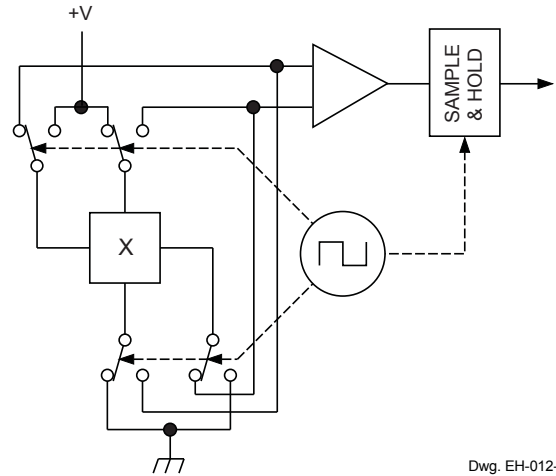
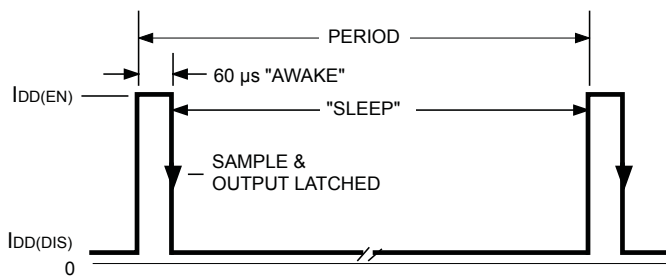

Dwg. EH-012-1

**Chopper-Stabilized Technique.** The Hall element can be considered as a resistor array similar to a Wheatstone bridge. A large portion of the offset is a result of the mismatching of these resistors. These devices use a proprietary dynamic offset cancellation technique, with an internal high-frequency clock to reduce the residual offset voltage of the Hall element that is normally caused by device overmolding, temperature dependencies, and thermal stress. The chopper-stabilizing technique cancels the mismatching of the resistor circuit by changing the direction of the current flowing through the Hall plate using CMOS switches and Hall voltage measurement taps, while maintaining the Hall-voltage signal that is induced by the external magnetic flux. The signal is then captured by a sample-and-hold circuit and further processed using low-offset bipolar circuitry. This technique produces devices that have an extremely stable quiescent Hall output voltage, are immune to thermal stress, and have precise recoverability after temperature cycling. This technique will also slightly degrade the device output repeatability. A relatively high sampling frequency is used in order that faster signals can be processed.

More detailed descriptions of the circuit operation can be found in Technical Paper STP 97-10, *Monolithic Magnetic Hall Sensing Using Dynamic Quadrature Offset Cancellation* and Technical Paper STP 99-1, *Chopper-Stabilized Amplifiers With A Track-and-Hold Signal Demodulator*.

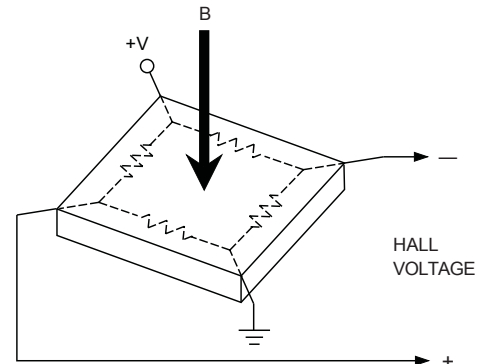

Dwg. AH-011-2

**Operation.** The output of this device switches low (turns on) when a magnetic field perpendicular to the Hall element exceeds the operate point  $B_{OPS}$  (or is less than  $B_{OPN}$ ). After turn-on, the output is capable of sinking up to 1 mA and the output voltage is  $V_{OUT(ON)}$ . When the magnetic field is reduced below the release point  $B_{RPS}$  (or increased above  $B_{RPN}$ ), the device output switches high (turns off). The difference in the magnetic operate and release points is the hysteresis ( $B_{hys}$ ) of the device. This built-in hysteresis allows clean switching of the output even in the presence of external mechanical vibration and electrical noise.

As used here, negative flux densities are defined as less than zero (algebraic convention) and -50 G is less than +10 G.



**Applications.** Allegro's pole-independent sensing technique allows for operation with either a north pole or south pole magnet orientation, enhancing the flexibility of the device in application assembling. The technology provides the same output polarity for either pole face.

It is strongly recommended that an external bypass capacitor be connected (in close proximity to the Hall element) between the supply and ground of the device to reduce both external noise and noise generated by the chopper-stabilization technique. This is especially true due to the relatively high impedance of battery supplies.

The simplest form of magnet that will operate these devices is a bar magnet with either pole near the branded surface of the device. Many other methods of operation are possible. Extensive applications information on magnets and Hall-effect devices is also available in the Allegro application note 27701, or at



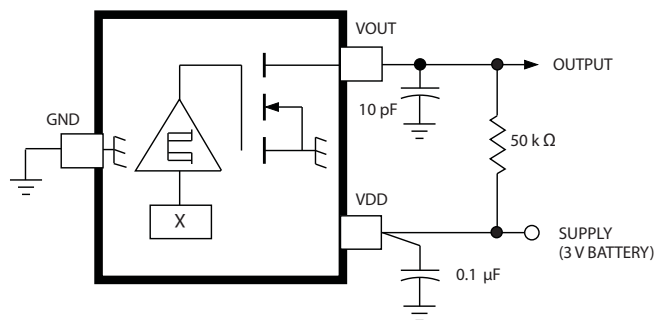
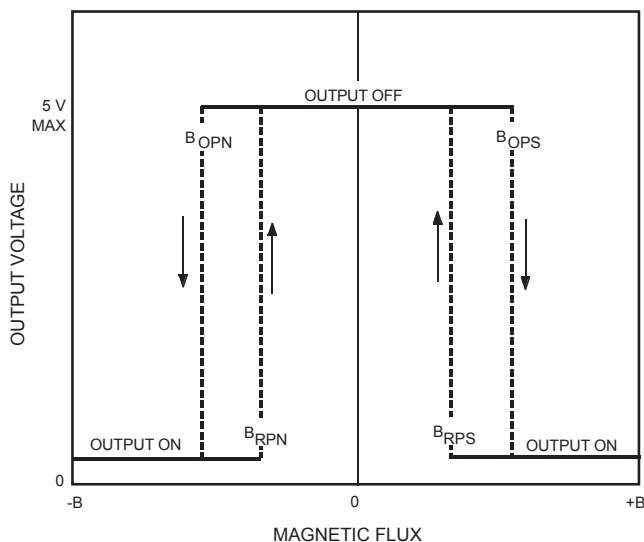

[www.allegromicro.com](http://www.allegromicro.com)

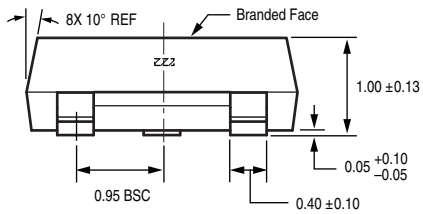
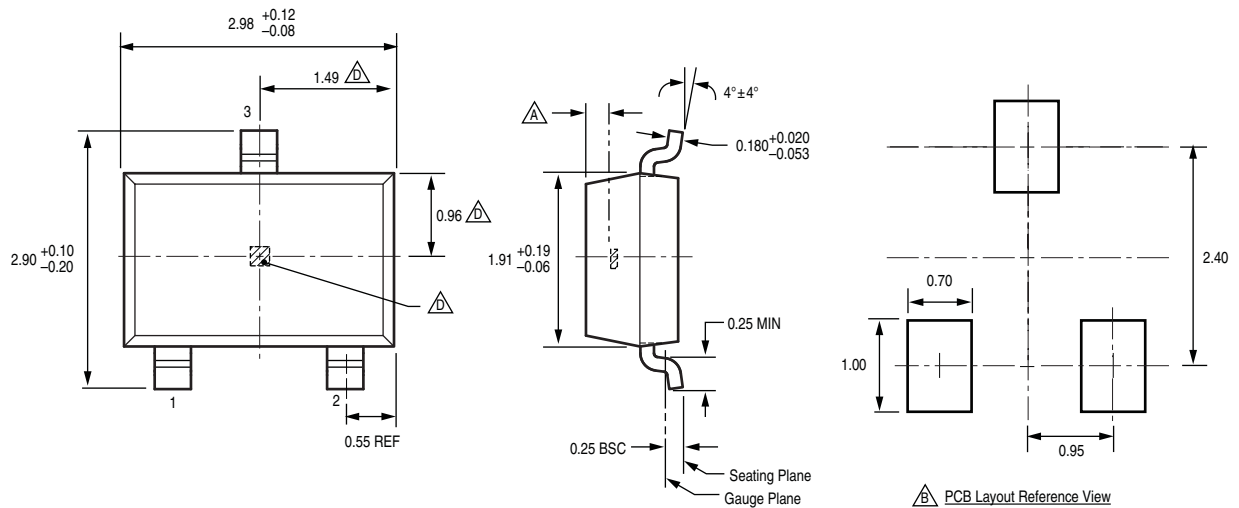

**Package LH, 3-Pin (SOT-23W)**



For Reference Only; not for tooling use (reference dwg. 802840)  
Dimensions in millimeters  
Dimensions exclusive of mold flash, gate burrs, and dambar protrusions  
Exact case and lead configuration at supplier discretion within limits shown

-  Active Area Depth, 0.28 mm REF
-  Reference land pattern layout  
All pads a minimum of 0.20 mm from all adjacent pads; adjust as necessary to meet application process requirements and PCB layout tolerances
-  Branding scale and appearance at supplier discretion
-  Hall element, not to scale

 PCB Layout Reference View

 Standard Branding Reference View

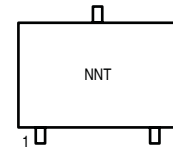

N = Last two digits of device part number  
T = Temperature code (letter)

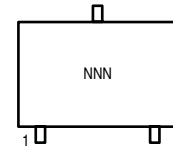

N = Last three digits of device part number

**Package UA, 3-Pin SIP**

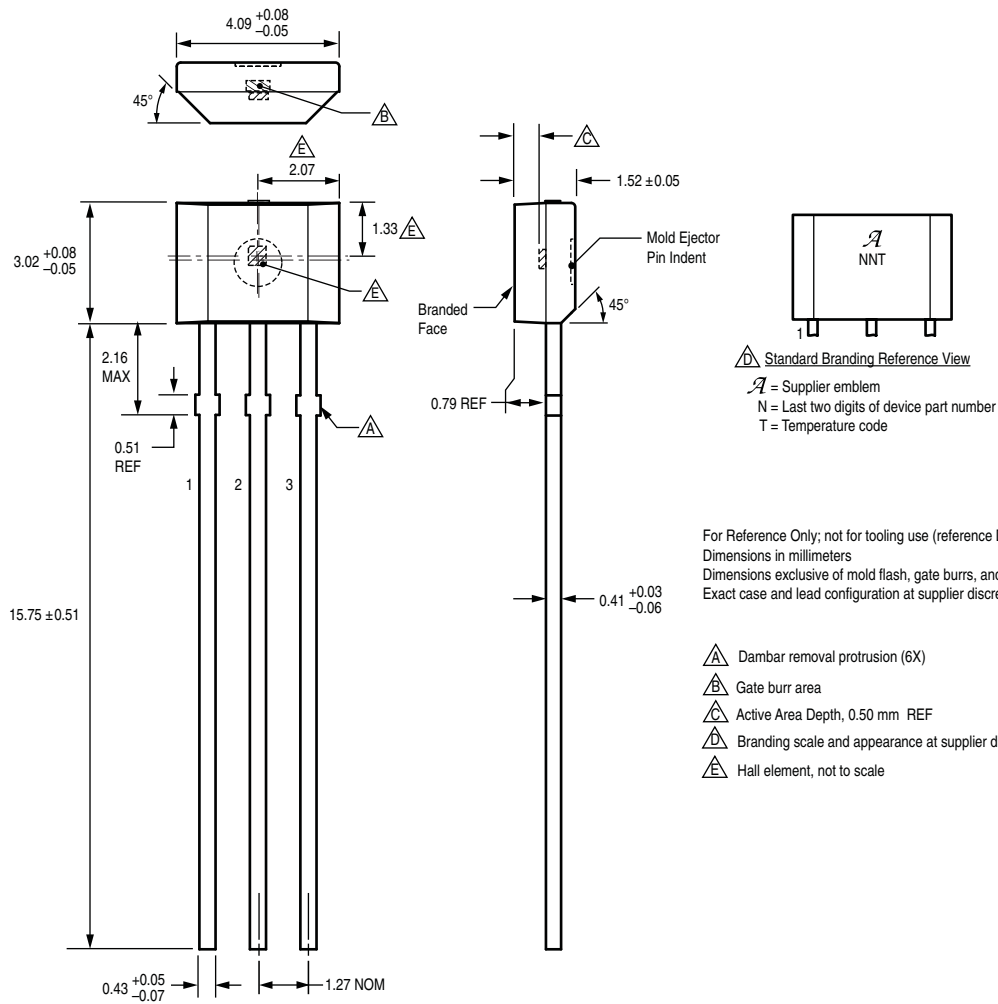

**Revision History**

<b>Revision</b>	<b>Revision Date</b>	<b>Description of Revision</b>
Rev. Y	October 29, 2012	Update product selection

Copyright ©2003-2013, Allegro MicroSystems, LLC

Allegro MicroSystems, LLC reserves the right to make, from time to time, such departures from the detail specifications as may be required to permit improvements in the performance, reliability, or manufacturability of its products. Before placing an order, the user is cautioned to verify that the information being relied upon is current.

Allegro's products are not to be used in life support devices or systems, if a failure of an Allegro product can reasonably be expected to cause the failure of that life support device or system, or to affect the safety or effectiveness of that device or system.

The information included herein is believed to be accurate and reliable. However, Allegro MicroSystems, LLC assumes no responsibility for its use; nor for any infringement of patents or other rights of third parties which may result from its use.

For the latest version of this document, visit our website:

[www.allegromicro.com](http://www.allegromicro.com)