



Chipsmall Limited consists of a professional team with an average of over 10 year of expertise in the distribution of electronic components. Based in Hongkong, we have already established firm and mutual-benefit business relationships with customers from,Europe,America and south Asia,supplying obsolete and hard-to-find components to meet their specific needs.

With the principle of “Quality Parts,Customers Priority,Honest Operation,and Considerate Service”,our business mainly focus on the distribution of electronic components. Line cards we deal with include Microchip,ALPS,ROHM,Xilinx,Pulse,ON,Everlight and Freescale. Main products comprise IC,Modules,Potentiometer,IC Socket,Relay,Connector.Our parts cover such applications as commercial,industrial, and automotives areas.

We are looking forward to setting up business relationship with you and hope to provide you with the best service and solution. Let us make a better world for our industry!



## Contact us

Tel: +86-755-8981 8866 Fax: +86-755-8427 6832

Email & Skype: info@chipsmall.com Web: www.chipsmall.com

Address: A1208, Overseas Decoration Building, #122 Zhenhua RD., Futian, Shenzhen, China





## AA3528CGCK

### 3.5 x 2.8 mm Surface Mount LED Lamp

#### DESCRIPTIONS

- The Green source color devices are made with AlGaInP on GaAs substrate Light Emitting Diode
- Electrostatic discharge and power surge could damage the LEDs
- It is recommended to use a wrist band or anti-electrostatic glove when handling the LEDs
- All devices, equipments and machineries must be electrically grounded

#### FEATURES

- Single color
- Suitable for all SMD assembly and solder process
- Available on tape and reel
- Ideal for backlighting
- Package: 2000 pcs / reel
- Moisture sensitivity level: 3
- RoHS compliant

#### APPLICATIONS

- Backlight
- Status indicator
- Home and smart appliances
- Wearable and portable devices
- Healthcare applications

#### ATTENTION

Observe precautions for handling electrostatic discharge sensitive devices



#### PACKAGE DIMENSIONS

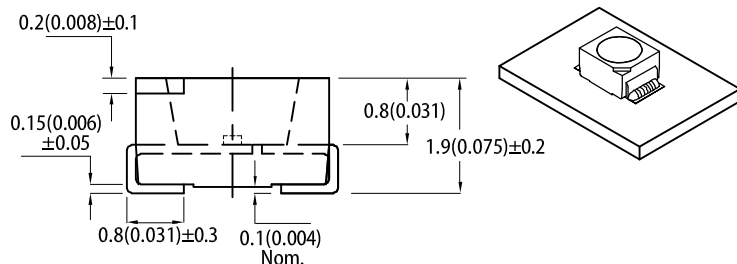
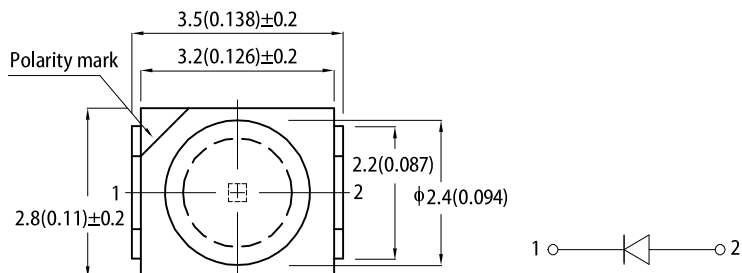

#### RECOMMENDED SOLDERING PATTERN

(units : mm; tolerance : ± 0.1)

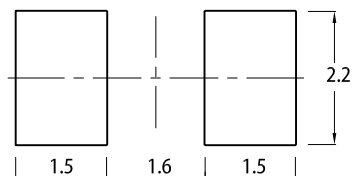

#### Notes:

1. All dimensions are in millimeters (inches).
2. Tolerance is ±0.25(0.01") unless otherwise noted.
3. The specifications, characteristics and technical data described in the datasheet are subject to change without prior notice.
4. The device has a single mounting surface. The device must be mounted according to the specifications.

#### SELECTION GUIDE

Part Number	Emitting Color (Material)	Lens Type	Iv (mcd) @ 20mA <sup>[2]</sup>		Viewing Angle <sup>[1]</sup>
			Min.	Typ.	2θ1/2
AA3528CGCK	■ Green (AlGaInP)	Water Clear	40	100	120°

Notes:  
 1. θ1/2 is the angle from optical centerline where the luminous intensity is 1/2 of the optical peak value.  
 2. Luminous intensity / luminous flux: +/-15%.  
 3. Luminous intensity value is traceable to CIE127-2007 standards.

ELECTRICAL / OPTICAL CHARACTERISTICS at  $T_A=25^{\circ}\text{C}$ 

Parameter	Symbol	Emitting Color	Value		Unit
			Typ.	Max.	
Wavelength at Peak Emission $I_F = 20\text{mA}$	$\lambda_{\text{peak}}$	Green	574	-	nm
Dominant Wavelength $I_F = 20\text{mA}$	$\lambda_{\text{dom}}^{[1]}$	Green	570	-	nm
Spectral Bandwidth at 50% $\Phi$ REL MAX $I_F = 20\text{mA}$	$\Delta\lambda$	Green	20	-	nm
Capacitance	C	Green	15	-	pF
Forward Voltage $I_F = 20\text{mA}$	$V_F^{[2]}$	Green	2.1	2.5	V
Reverse Current ( $V_R = 5\text{V}$ )	$I_R$	Green	-	10	$\mu\text{A}$
Temperature Coefficient of $\lambda_{\text{peak}}$ $I_F = 20\text{mA}$ , $-10^{\circ}\text{C} \leq T \leq 85^{\circ}\text{C}$	$\text{TC}_{\lambda_{\text{peak}}}$	Green	0.12	-	$\text{nm}/^{\circ}\text{C}$
Temperature Coefficient of $\lambda_{\text{dom}}$ $I_F = 20\text{mA}$ , $-10^{\circ}\text{C} \leq T \leq 85^{\circ}\text{C}$	$\text{TC}_{\lambda_{\text{dom}}}$	Green	0.09	-	$\text{nm}/^{\circ}\text{C}$
Temperature Coefficient of $V_F$ $I_F = 20\text{mA}$ , $-10^{\circ}\text{C} \leq T \leq 85^{\circ}\text{C}$	$\text{TC}_V$	Green	-1.8	-	$\text{mV}/^{\circ}\text{C}$

## Notes:

1. The dominant wavelength ( $\lambda_d$ ) above is the setup value of the sorting machine. (Tolerance  $\lambda_d : \pm 1\text{nm}$ .)
2. Forward voltage:  $\pm 0.1\text{V}$ .
3. Wavelength value is traceable to CIE127-2007 standards.
4. Excess driving current and / or operating temperature higher than recommended conditions may result in severe light degradation or premature failure.

ABSOLUTE MAXIMUM RATINGS at  $T_A=25^{\circ}\text{C}$ 

Parameter	Symbol	Value	Unit
Power Dissipation	$P_D$	75	mW
Reverse Voltage	$V_R$	5	V
Junction Temperature	$T_j$	115	$^{\circ}\text{C}$
Operating Temperature	$T_{\text{op}}$	-40 to +85	$^{\circ}\text{C}$
Storage Temperature	$T_{\text{stg}}$	-40 to +85	$^{\circ}\text{C}$
DC Forward Current	$I_F$	30	mA
Peak Forward Current	$I_{\text{FM}}^{[1]}$	150	mA
Electrostatic Discharge Threshold (HBM)	-	3000	V
Thermal Resistance (Junction / Ambient)	$R_{\text{th JA}}^{[2]}$	370	$^{\circ}\text{C}/\text{W}$
Thermal Resistance (Junction / Solder point)	$R_{\text{th JS}}^{[2]}$	210	$^{\circ}\text{C}/\text{W}$

## Notes:

1. 1/10 Duty Cycle, 0.1ms Pulse Width.
2.  $R_{\text{th JA}}$ ,  $R_{\text{th JS}}$  Results from mounting on PC board FR4 (pad size  $\geq 16\text{ mm}^2$  per pad).
3. Relative humidity levels maintained between 40% and 60% in production area are recommended to avoid the build-up of static electricity – Ref JEDEC/JESD625-A and JEDEC/J-STD-033.

## TECHNICAL DATA

### RELATIVE INTENSITY vs. WAVELENGTH

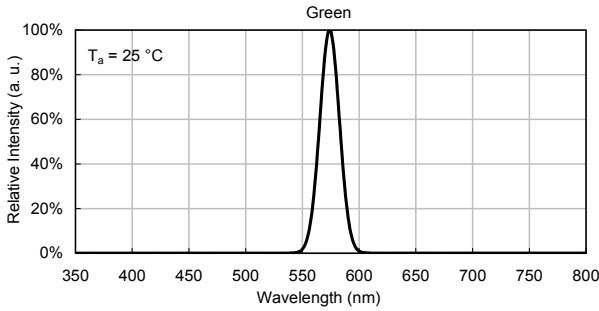

### SPATIAL DISTRIBUTION

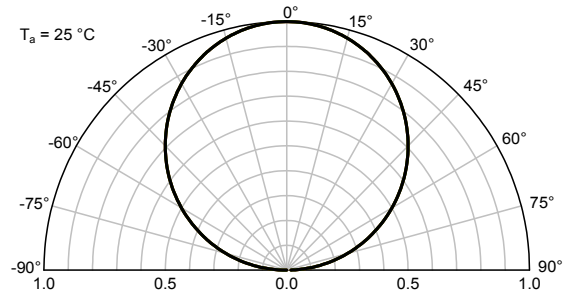

## GREEN

Forward Current vs. Forward Voltage

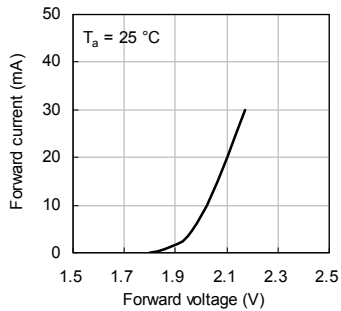

Luminous Intensity vs. Forward Current

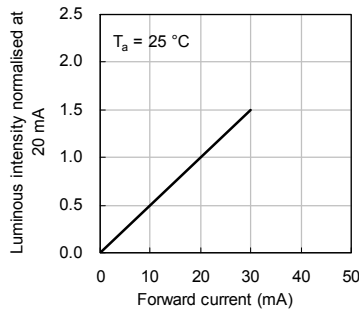

Forward Current Derating Curve

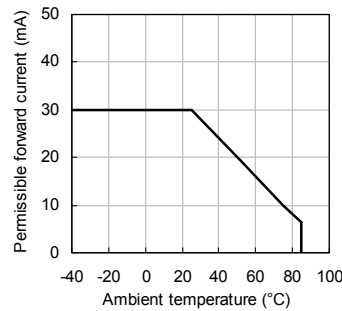

Luminous Intensity vs. Ambient Temperature

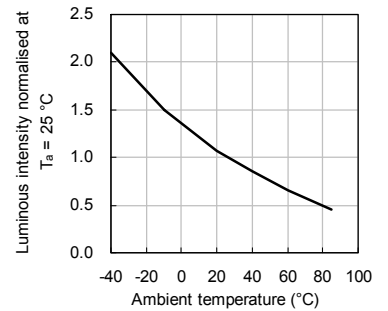

### REFLOW SOLDERING PROFILE for LEAD-FREE SMD PROCESS

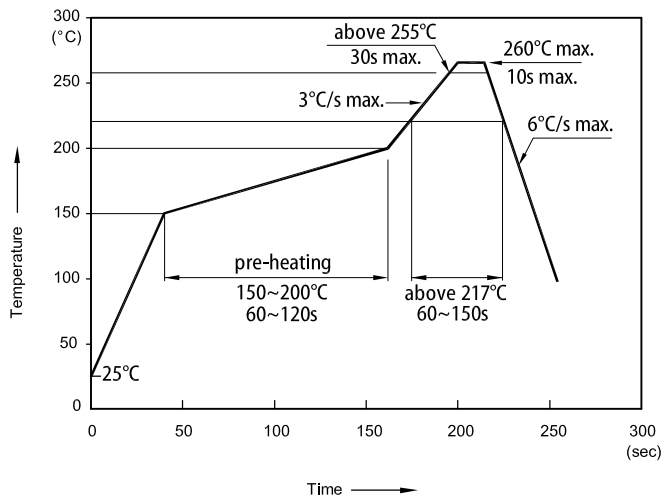

- Notes:
1. Don't cause stress to the LEDs while it is exposed to high temperature.
  2. The maximum number of reflow soldering passes is 2 times.
  3. Reflow soldering is recommended. Other soldering methods are not recommended as they might cause damage to the product.

### TAPE SPECIFICATIONS (units : mm)

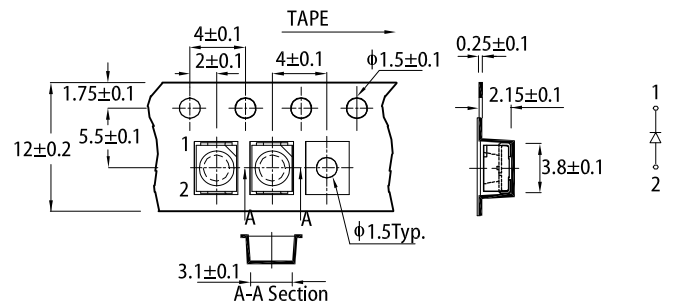

### REEL DIMENSION (units : mm)

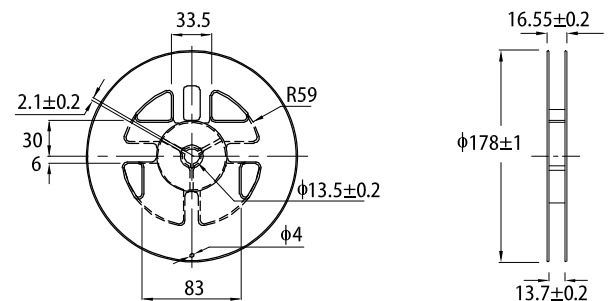

## PACKING & LABEL SPECIFICATIONS

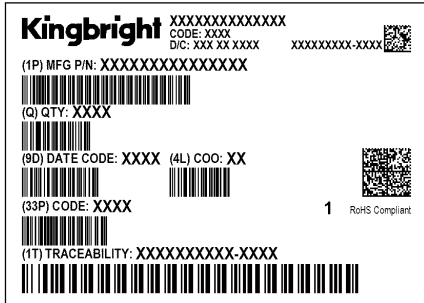
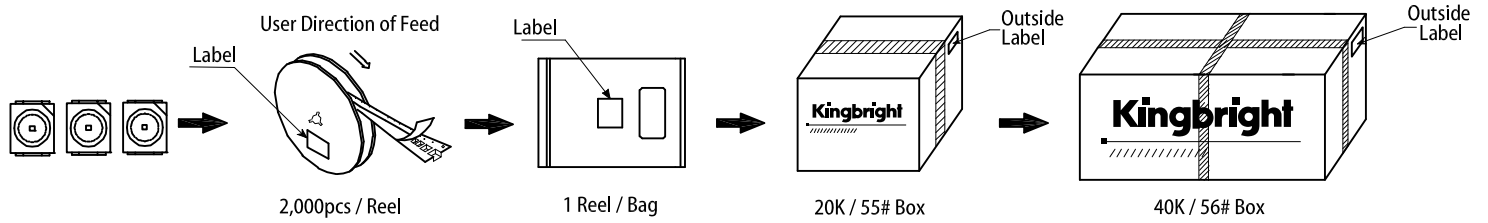

### PRECAUTIONARY NOTES

1. The information included in this document reflects representative usage scenarios and is intended for technical reference only.
2. The part number, type, and specifications mentioned in this document are subject to future change and improvement without notice. Before production usage customer should refer to the latest datasheet for the updated specifications.
3. When using the products referenced in this document, please make sure the product is being operated within the environmental and electrical limits specified in the datasheet. If customer usage exceeds the specified limits, Kingbright will not be responsible for any subsequent issues.
4. The information in this document applies to typical usage in consumer electronics applications. If customer's application has special reliability requirements or have life-threatening liabilities, such as automotive or medical usage, please consult with Kingbright representative for further assistance.
5. The contents and information of this document may not be reproduced or re-transmitted without permission by Kingbright.
6. All design applications should refer to Kingbright application notes available at <http://www.KingbrightUSA.com/ApplicationNotes>