



Chipsmall Limited consists of a professional team with an average of over 10 year of expertise in the distribution of electronic components. Based in Hongkong, we have already established firm and mutual-benefit business relationships with customers from,Europe,America and south Asia,supplying obsolete and hard-to-find components to meet their specific needs.

With the principle of “Quality Parts,Customers Priority,Honest Operation,and Considerate Service”,our business mainly focus on the distribution of electronic components. Line cards we deal with include Microchip,ALPS,ROHM,Xilinx,Pulse,ON,Everlight and Freescale. Main products comprise IC,Modules,Potentiometer,IC Socket,Relay,Connector.Our parts cover such applications as commercial,industrial, and automotives areas.

We are looking forward to setting up business relationship with you and hope to provide you with the best service and solution. Let us make a better world for our industry!



## Contact us

Tel: +86-755-8981 8866 Fax: +86-755-8427 6832

Email & Skype: info@chipsmall.com Web: www.chipsmall.com

Address: A1208, Overseas Decoration Building, #122 Zhenhua RD., Futian, Shenzhen, China



**500mA High Efficiency Charge Pump for White LED Flash Applications**

**General Description**

The AAT3112 is a member of Skyworks' Total Power Management IC™ (TPMIC™) family. It is a dual voltage doubling charge pump that provides a regulated output voltage. It operates with an input voltage range of 2.7 to 5.0 volts. The device can deliver a constant 200mA output load current and up to 500mA of pulsed current. The 500mA peak current capability of the AAT3112 makes it ideal for white LED flash applications. A low external parts count (two 1μF flying capacitors and two small capacitors at V<sub>IN</sub> and V<sub>OUT</sub>) makes the AAT3112 ideally suited for small battery-powered applications.

The AAT3112 has a thermal management system to protect the device in the event of a short-circuit condition at the output pin. Built-in soft-start circuitry prevents excessive inrush current during start-up. A high charge pump switching frequency enables the use of very small external capacitors. A low current shutdown feature disconnects the load from V<sub>IN</sub> and reduces quiescent current to less than 1μA. The AAT3112 is available in a Pb-free 16-pin 3x3mm QFN package and is rated over the -40°C to +85°C temperature range.

**Features**

- Input Voltage Range:
  - AAT3112-5.0: 2.7V to 5.0V
  - AAT3112-4.5: 2.7V to 4.5V
- Up to 500mA Peak Output Current
- 200mA Continuous Output Current
- I<sub>Q</sub> < 1μA in Shutdown
- Regulated 4.5V or 5.0V Output
- 26μA of Quiescent Current
- Small Application Circuit
- Automatic Soft Start
- No Inductors
- Short-Circuit/Over-Temperature Protection
- 16-Pin 3x3mm QFN Package
- Temperature Range: -40°C to +85°C

**Applications**

- General-Purpose High-Current Boost Supply
- White LED Backlighting
- White LED Photo Flash

**Typical Application**

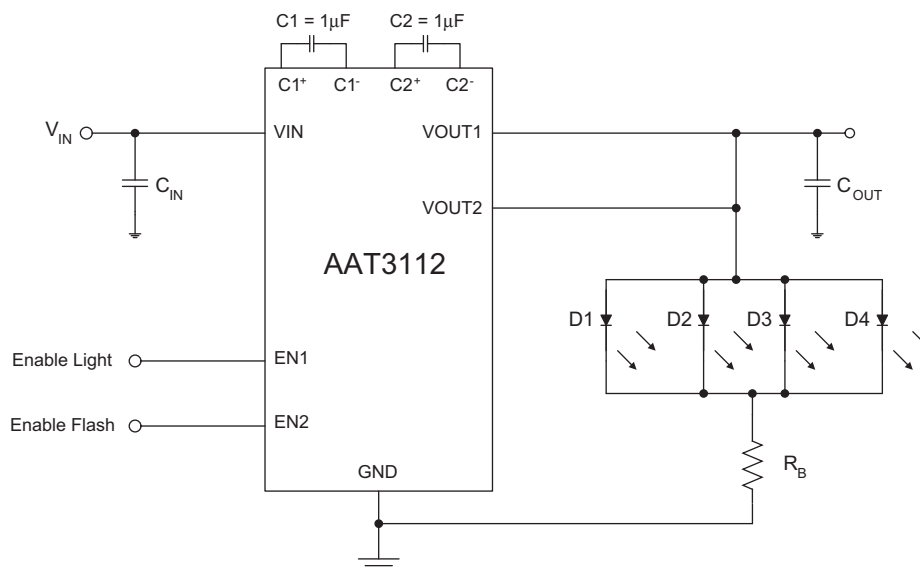

# AAT3112

## 500mA High Efficiency Charge Pump for White LED Flash Applications

### Pin Descriptions

Pin #	Symbol	Function
1, 4, 8, 12	N/C	No connect.
2	C2+	Flying capacitor 2 positive terminal. Connect 1 $\mu$ F capacitor between C2+ and C2-.
3	C2-	Flying capacitor 2 negative terminal.
5	VIN	Input voltage. Connect to Pin 11.
6	GND	Ground connection.
7	EN2	Enable pin. When connected high, Charge Pump 2 is enabled. When connected low, this pin disables the charge pump.
9	EN1	Enable pin. When connected high, Charge Pump 1 is enabled. When connected low, this pin disables the charge pump.
10	GND	Ground connection.
11	VIN	Input voltage. Connect to Pin 5.
12	VOUT1	Output pin for regulated output voltage. Bypass this pin to ground with a low ESR 10 $\mu$ F capacitor.
14	C1+	Flying capacitor 1 positive terminal. Connect 1 $\mu$ F capacitor between C1+ and C1-.
15	C1-	Flying capacitor 1 negative terminal.
16	VOUT2	Regulated output voltage 2. Must be connected to V <sub>OUT1</sub> for higher current applications. If used separately, bypass this pin to ground with a low ESR 10 $\mu$ F capacitor.
EP		Exposed paddle (bottom); connect to GND directly beneath package.

### Pin Configuration

QFN33-16  
(Top View)

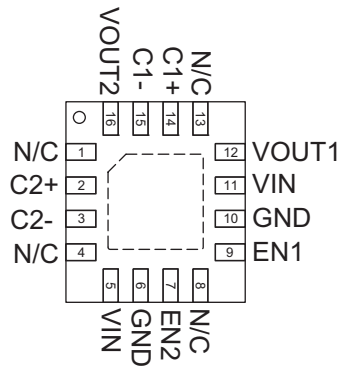

**500mA High Efficiency Charge Pump for White LED Flash Applications****Absolute Maximum Ratings<sup>1</sup>**

Symbol	Description	Value	Units
V <sub>IN</sub>	Input Voltage	-0.3 to 6	V
V <sub>OUT</sub>	Charge Pump Output	-0.3 to 6	V
V <sub>EN</sub>	EN to GND Voltage	-0.3 to 6	V
T <sub>J</sub>	Operating Junction Temperature Range	-40 to 150	°C
T <sub>LEAD</sub>	Maximum Soldering Temperature (at leads, 10 sec)	300	°C

**Thermal Information**

Symbol	Description	Value	Units
P <sub>D</sub>	Maximum Power Dissipation	2.0	W
θ <sub>JA</sub>	Maximum Thermal Resistance <sup>2</sup>	50	°C/W

1. Stresses above those listed in Absolute Maximum Ratings may cause permanent damage to the device. Functional operation at conditions other than the operating conditions specified is not implied. Only one Absolute Maximum Rating should be applied at any one time.

2. Mounted on an FR4 board.



# DATA SHEET

# AAT3112

## 500mA High Efficiency Charge Pump for White LED Flash Applications

### Electrical Characteristics<sup>1</sup>

$V_{IN} = 3.3V$ ,  $V_{OUT} = 5.0V$ ,  $C_{IN} = C_{OUT} = 10\mu F$ ,  $C_1 = C_2 = 1.0\mu F$ ;  $T_A = -40^\circ C$  to  $+85^\circ C$ , unless otherwise noted. Typical values are  $T_A = 25^\circ C$ .

Symbol	Description	Conditions	Min	Typ	Max	Units
<b>AAT3112-4.5</b>						
<b>Input Power Supply</b>						
$V_{IN}$	Operation Range		2.7		4.5	V
$I_Q$	Quiescent Current <sup>2</sup>	$2.7 \leq V_{IN} \leq 4.5$ , $I_{OUT} = 0mA$ ; $EN1 = EN2 = V_{IN}$		26	60	$\mu A$
$I_{SHDN}$	Shutdown Current	$EN1 = EN2 = 0$			1.0	$\mu A$
$I_{OUT}$	Pulsed Output Current	$V_{IN} = 3.6V$ ; $V_{OUT} = 4.0V$ ; $T_{PULSE} = 50ms$		590		mA
		$V_{IN} = 3.6V$ ; $V_{OUT} = 4.0V$ ; $T_{PULSE} = 500ms$		500		
$V_{OUT}$	Output Voltage	$2.7 \leq V_{IN} \leq 4.5$ , $I_{OUT} = 100mA$	4.32	4.5	4.68	V
		$3.0 \leq V_{IN} \leq 4.5$ , $I_{OUT} = 200mA$	4.32	4.5	4.68	
<b>Charge Pump Section</b>						
$F_{CLK}$	Clock Frequency			750		kHz
$\eta_{CP}$	Charge Pump Efficiency	$V_{IN} = 2.7V$ ; $I_{OUT} = 100mA$		80		%
<b>EN</b>						
$V_{EN(L)}$	Enable Threshold Low				0.3	V
$V_{EN(H)}$	Enable Threshold High		1.4			V
$I_{EN}$	EN Input Leakage		-1.0		1.0	$\mu A$
<b>AAT3112-5.0</b>						
<b>Input Power Supply</b>						
$V_{IN}$	Operation Range		2.7		5.0	V
$I_Q$	Quiescent Current <sup>2</sup>	$2.7 \leq V_{IN} \leq 5.0$ , $I_{OUT} = 0mA$ ; $EN1 = EN2 = V_{IN}$		26	60	$\mu A$
$I_{SHDN}$	Shutdown Current	$EN1 = EN2 = 0$			1.0	$\mu A$
$I_{OUT}$	Pulsed Output Current	$V_{IN} = 3.6V$ ; $V_{OUT} = 4.5V$ ; $T_{PULSE} = 50ms$		600		mA
		$V_{IN} = 3.6V$ ; $V_{OUT} = 4.5V$ ; $T_{PULSE} = 500ms$		500		
$V_{OUT}$	Output Voltage	$2.7 \leq V_{IN} \leq 5.0$ , $I_{OUT} = 100mA$	4.8	5.0	5.2	V
		$3.0 \leq V_{IN} \leq 5.0$ , $I_{OUT} = 200mA$	4.8	5.0	5.2	
<b>Charge Pump Section</b>						
$F_{CLK}$	Clock Frequency			750		kHz
$\eta_{CP}$	Charge Pump Efficiency	$V_{IN} = 2.7V$ ; $I_{OUT} = 100mA$		85		%
<b>EN</b>						
$V_{EN(L)}$	Enable Threshold Low				0.3	V
$V_{EN(H)}$	Enable Threshold High		1.4			V
$I_{EN}$	EN Input Leakage		-1.0		1.0	$\mu A$

- The AAT3112 is guaranteed to meet performance specifications over the  $-40^\circ C$  to  $+85^\circ C$  operating temperature range and is assured by design, characterization, and correlation with statistical process controls.
- $V_{OUT1}$  and  $V_{OUT2}$  are pulled high to prevent switching.

# AAT3112

## 500mA High Efficiency Charge Pump for White LED Flash Applications

### Typical Characteristics

$V_{IN} = 3.5V$ ,  $C_{IN} = C_{OUT} = 10\mu F$ ,  $C_1 = C_2 = 1\mu F$ ;  $T_A = 25^\circ C$ , unless otherwise noted.

$V_{IN}$  vs.  $V_{IH}$

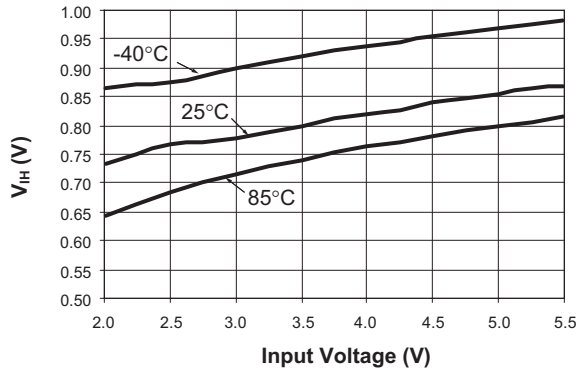

$V_{IN}$  vs.  $V_{IL}$

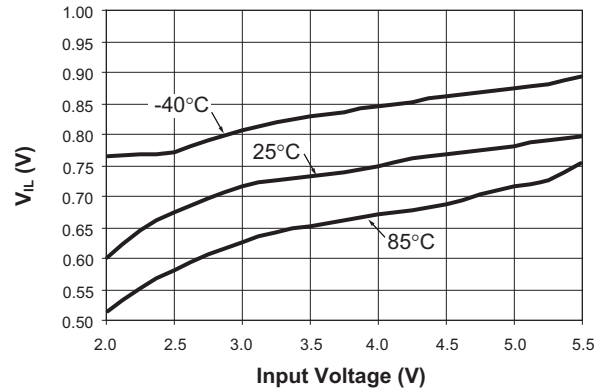

$V_{SHDN}$  Threshold vs. Input Voltage

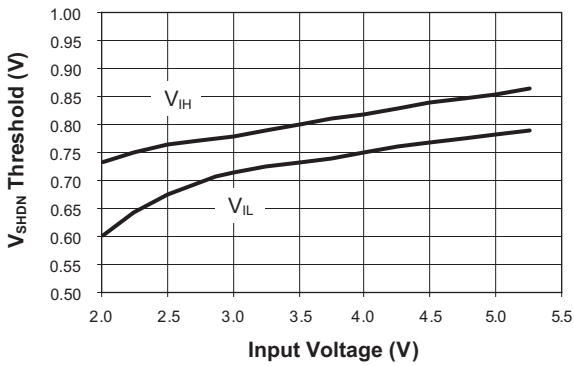

# AAT3112

## 500mA High Efficiency Charge Pump for White LED Flash Applications

### Typical Characteristics-AAT3112-4.5V

$V_{IN} = 3.5V$ ,  $C_{IN} = C_{OUT} = 10\mu F$ ,  $C_1 = C_2 = 1\mu F$ ;  $T_A = 25^\circ C$ , unless otherwise noted.

Output Voltage vs. Output Current

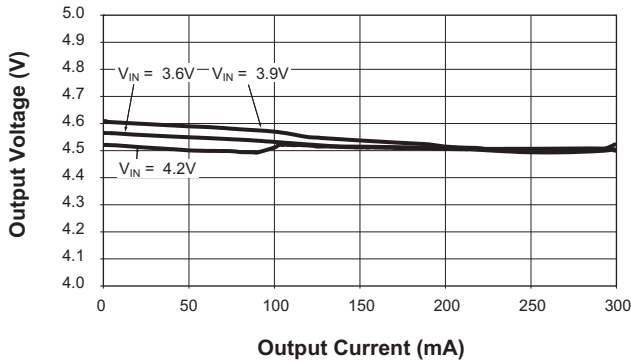

Supply Current vs. Supply Voltage (No Load, No Switching)

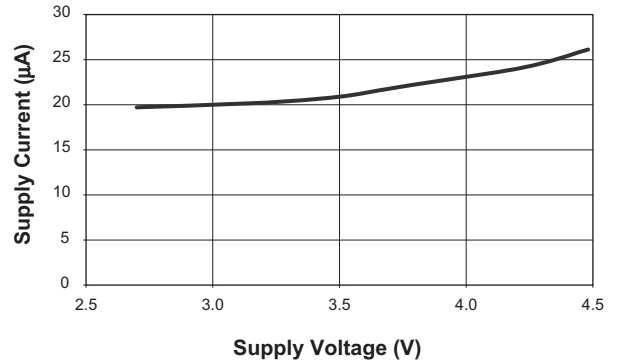

Startup Time with 100mA Load

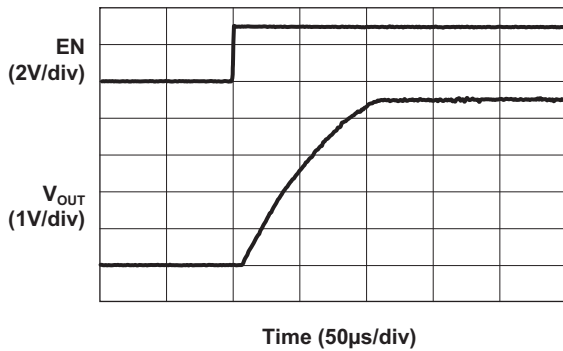

Startup Time with 200mA Load

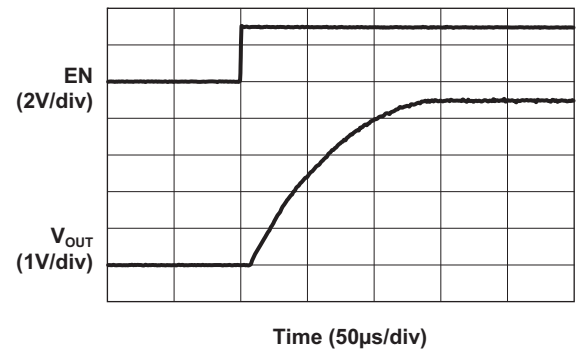

Maximum Current Pulse vs. Input Voltage (50ms pulse;  $V_{OUT} > 4.0V$ )

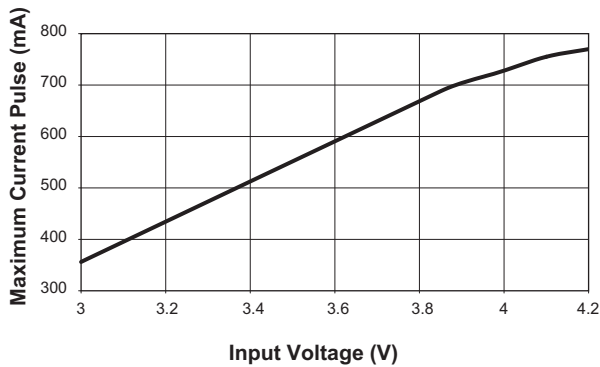

Efficiency vs. Input Voltage

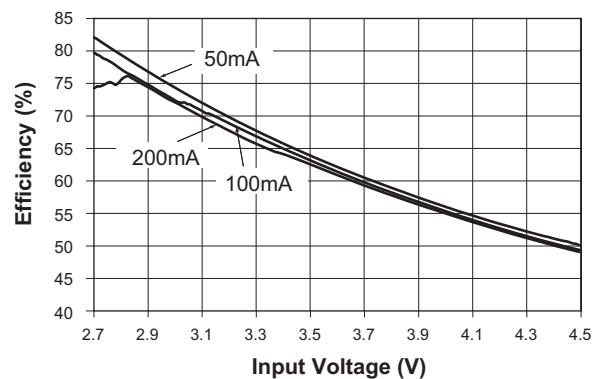

# AAT3112

## 500mA High Efficiency Charge Pump for White LED Flash Applications

### Typical Characteristics-AAT3112-4.5V

$V_{IN} = 3.5V$ ,  $C_{IN} = C_{OUT} = 10\mu F$ ,  $C_1 = C_2 = 1\mu F$ ;  $T_A = 25^\circ C$ , unless otherwise noted.

**Load Transient Response**  
( $V_{IN} = 3.0V$ )

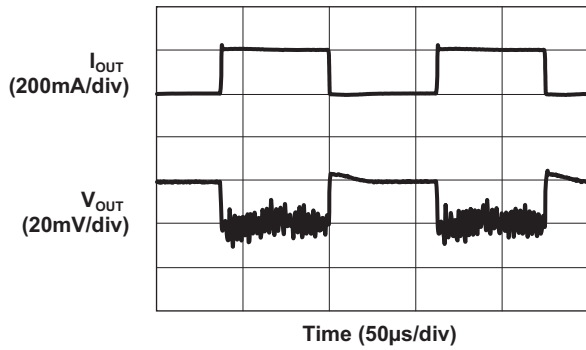

**Load Transient Response**  
( $V_{IN} = 4.2V$ )

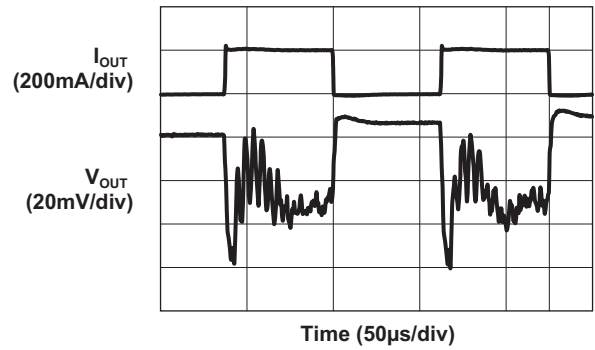

**Input and Output Ripples**  
( $I_{OUT} = 50mA @ V_{IN} = 3.5V$ )

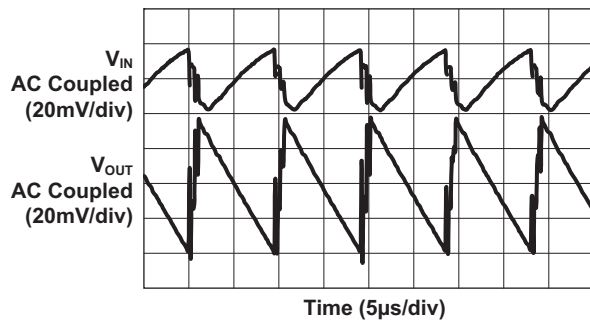

**Input and Output Ripples**  
( $I_{OUT} = 100mA @ V_{IN} = 3.5V$ )

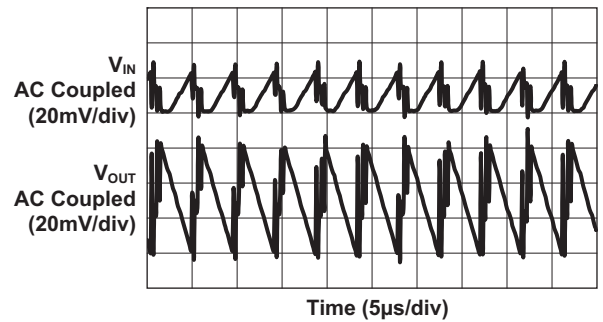

**Output Current vs. Input Voltage**  
(500ms Pulse Time;  $V_{OUT} > 4.0V$ )

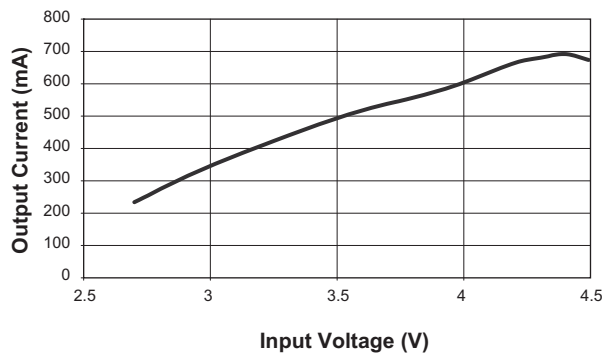

**Output Current vs. Input Voltage (70°C)**  
( $V_{OUT} > 4.0V$ )

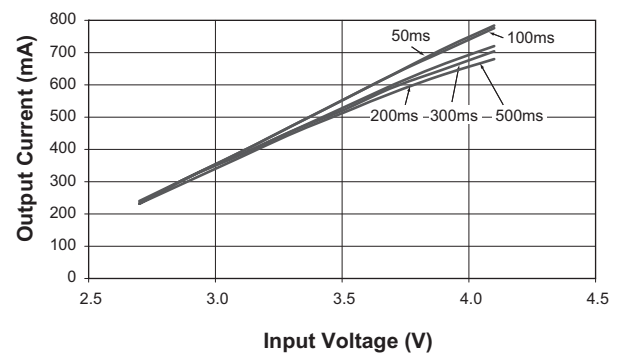



# AAT3112

## 500mA High Efficiency Charge Pump for White LED Flash Applications

### Typical Characteristics-AAT3112-4.5V

$V_{IN} = 3.5V$ ,  $C_{IN} = C_{OUT} = 10\mu F$ ,  $C_1 = C_2 = 1\mu F$ ;  $T_A = 25^\circ C$ , unless otherwise noted.

Output Voltage vs. Input Voltage for Pulsed High Current ( $I_{OUT} = 500mA$ )

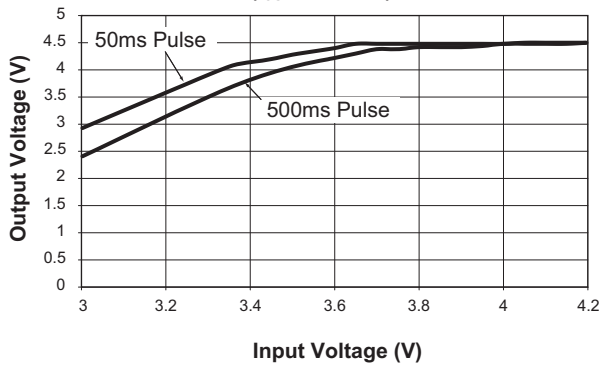

# AAT3112

## 500mA High Efficiency Charge Pump for White LED Flash Applications

### Typical Characteristics-AAT3112-5.0V

$V_{IN} = 3.5V$ ,  $C_{IN} = C_{OUT} = 10\mu F$ ,  $C_1 = C_2 = 1\mu F$ ;  $T_A = 25^\circ C$ , unless otherwise noted.

Output Voltage vs. Output Current

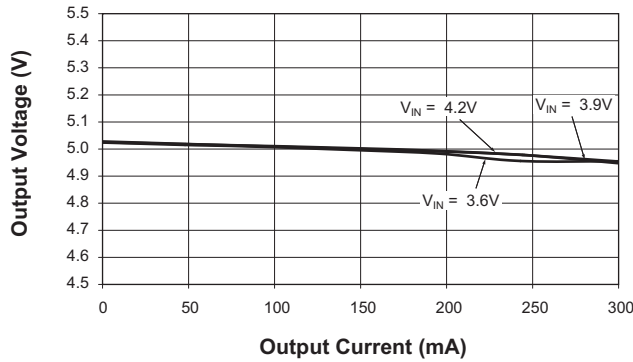

Supply Current vs. Supply Voltage (No Load, No Switching)

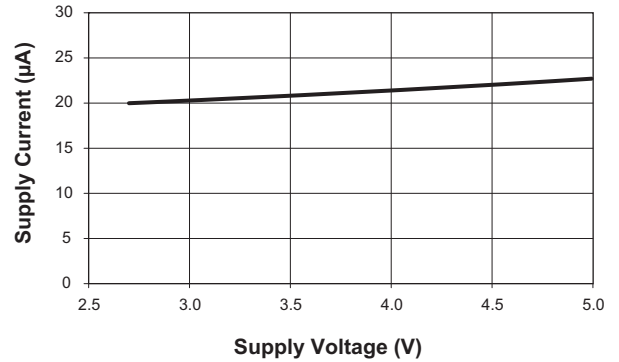

Startup Time with 100mA Load

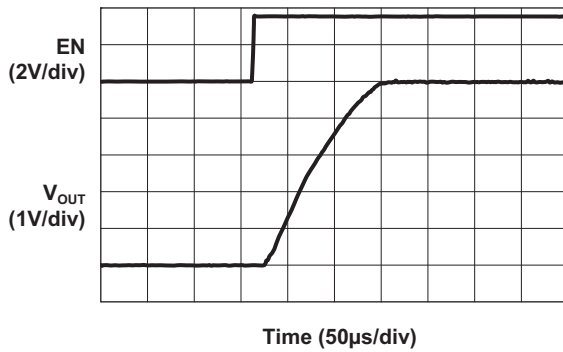

Startup Time with 200mA Load

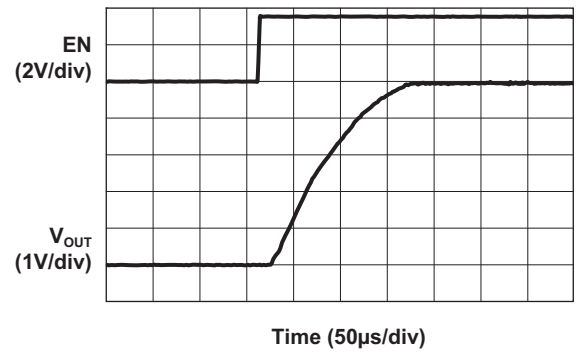

Maximum Current Pulse vs. Input Voltage (50ms pulse;  $V_{OUT} > 4.5V$ )

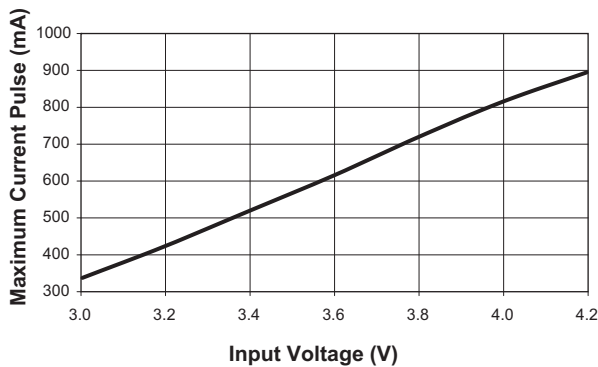

Efficiency vs. Input Voltage

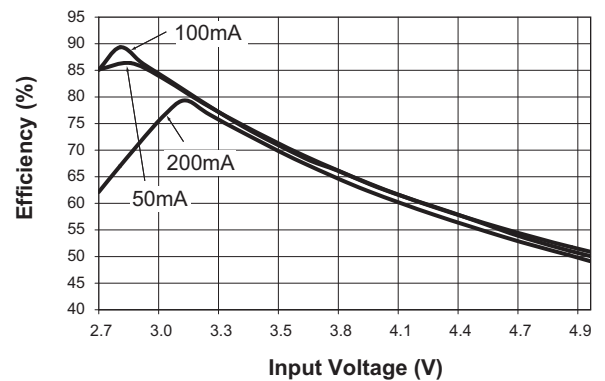

# AAT3112

## 500mA High Efficiency Charge Pump for White LED Flash Applications

### Typical Characteristics-AAT3112-5.0V

$V_{IN} = 3.5V$ ,  $C_{IN} = C_{OUT} = 10\mu F$ ,  $C_1 = C_2 = 1\mu F$ ;  $T_A = 25^\circ C$ , unless otherwise noted.

**Load Transient Response**  
( $V_{IN} = 3.0V$ )

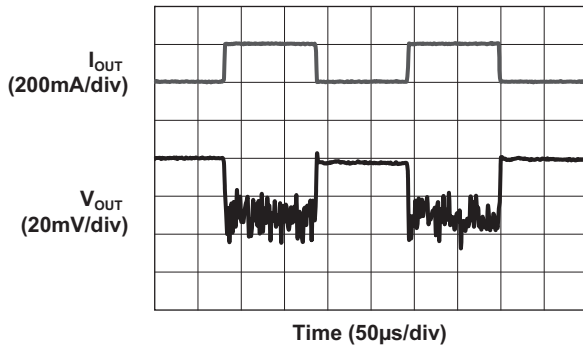

**Load Transient Response**  
( $V_{IN} = 4.2V$ )

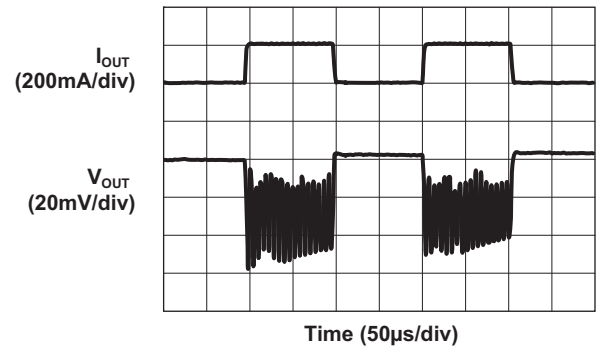

**Input and Output Ripples**  
( $I_{OUT} = 50mA @ V_{IN} = 3.5V$ )

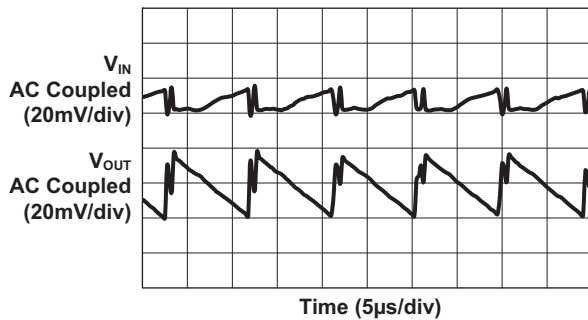

**Input and Output Ripples**  
( $I_{OUT} = 100mA @ V_{IN} = 3.5V$ )

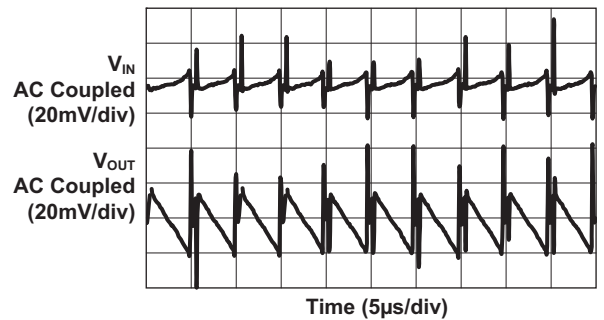

**Output Current vs. Input Voltage**  
(500ms Pulse Time;  $V_{OUT} > 4.5V$ )

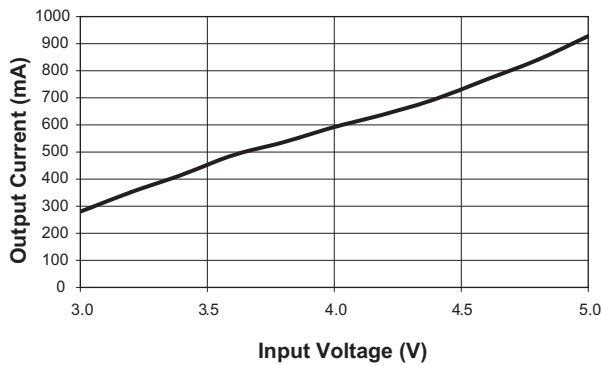

**Output Current vs. Input Voltage (70°C)**  
( $V_{OUT} > 4.5V$ )

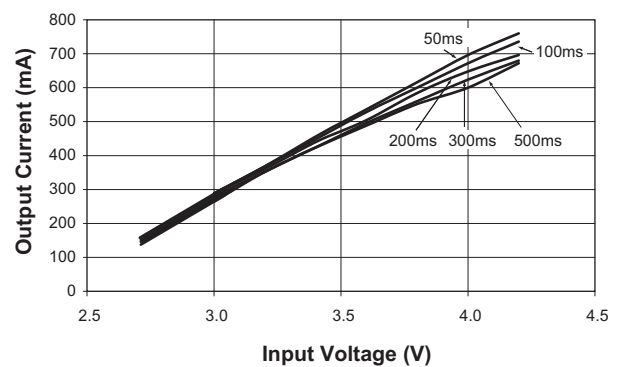

# AAT3112

## 500mA High Efficiency Charge Pump for White LED Flash Applications

### Typical Characteristics-AAT3112-5.0V

$V_{IN} = 3.5V$ ,  $C_{IN} = C_{OUT} = 10\mu F$ ,  $C_1 = C_2 = 1\mu F$ ;  $T_A = 25^\circ C$ , unless otherwise noted.

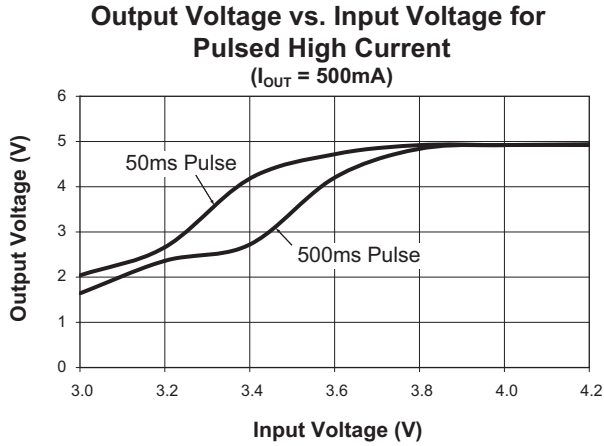

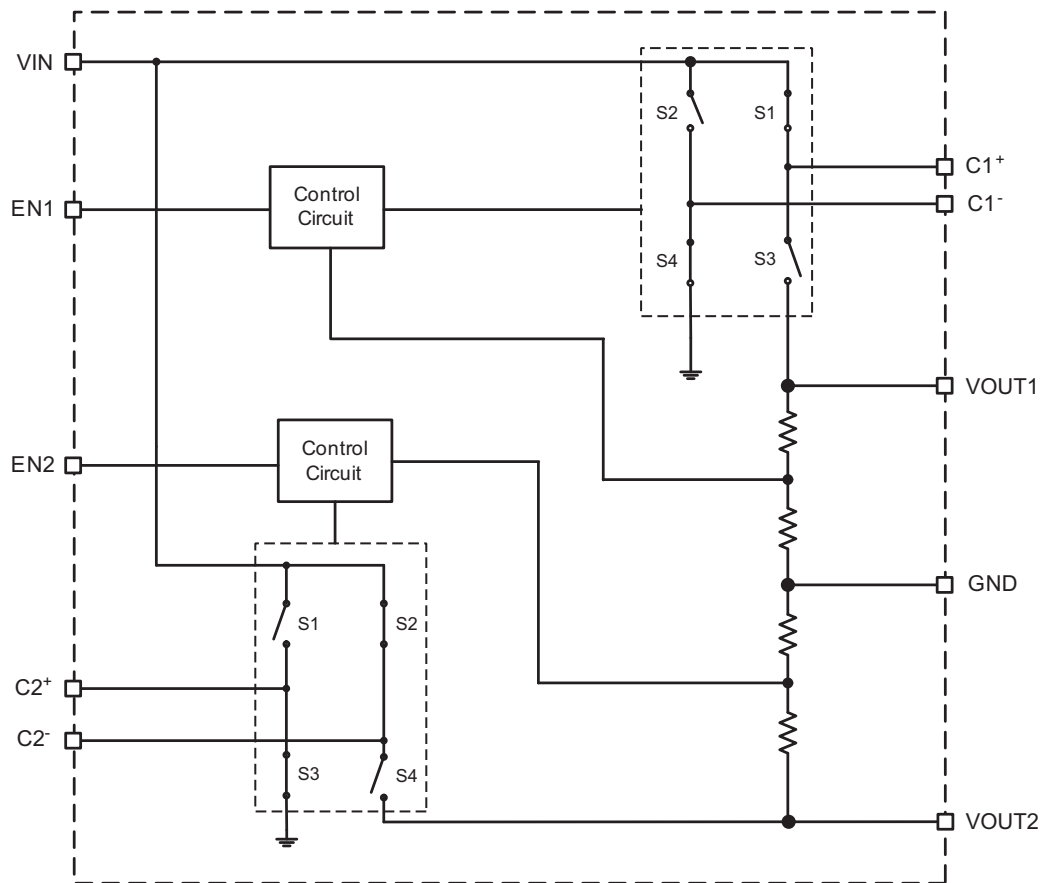
**500mA High Efficiency Charge Pump for White LED Flash Applications****Functional Block Diagram****Functional Description**

The AAT3112 is a dual charge pump intended for high-current applications. This device boosts an input voltage to a regulated output voltage. Regulation is achieved by sensing the output voltage through an internal resistor divider network. The AAT3112 requires only four external components: two 1.0 $\mu$ F ceramic capacitors for the charge pump (C1 and C2), one 10 $\mu$ F ceramic capacitor for  $C_{IN}$ , and one 10 $\mu$ F ceramic capacitor for  $C_{OUT}$ .

The AAT3112 is designed to deliver 200mA of continuous current and up to 500mA of pulsed current. Each charge pump engine has an independent enable pin to extend battery life. The charge pump switching frequency is approximately 750kHz, enabling the use of small external flying capacitors.

The AAT3112 has complete output short-circuit and thermal protection to safeguard the device under extreme operating conditions. An internal thermal protection circuit senses die temperature and will shut down the device if the internal junction temperature exceeds approximately 145°C.

**500mA High Efficiency Charge Pump for White LED Flash Applications****Applications Information****Charge Pump Efficiency**

The AAT3112 is a regulated output voltage doubling charge pump. The efficiency ( $\eta$ ) can simply be defined as a linear voltage regulator with an effective output voltage that is equal to two times the input voltage. Efficiency ( $\eta$ ) for an ideal voltage doubler can typically be expressed as the output power divided by the input power:

$$\eta = \frac{P_{OUT}}{P_{IN}}$$

In addition, with an ideal voltage doubling charge pump, the output current may be expressed as half the input current. The expression to define the ideal efficiency ( $\eta$ ) can be rewritten as:

$$\eta = \frac{P_{OUT}}{P_{IN}} = \frac{V_{OUT} \times I_{OUT}}{V_{IN} \times 2I_{OUT}} = \frac{V_{OUT}}{2V_{IN}}$$

-or-

$$\eta(\%) = 100 \left( \frac{V_{OUT}}{2V_{IN}} \right)$$

For a charge pump with an output of 4.5V and a nominal input of 2.8V, the theoretical efficiency is 80.4%. Due to internal switching losses and IC quiescent current consumption, the actual efficiency can be measured at 79.6%. These figures are in close agreement across a wide range of output load conditions. Efficiency will decrease as load current drops below 0.05mA or when the level of  $V_{IN}$  approaches  $V_{OUT}$ .

**Capacitor Selection**

Careful selection of the four external capacitors  $C_{IN}$ ,  $C_1$ ,  $C_2$ , and  $C_{OUT}$  is important because they will affect turn-on time, output ripple, and transient performance. Optimum performance will be obtained when low equivalent series resistance (ESR) ceramic capacitors are used. In general, low ESR may be defined as less than 100m $\Omega$ .

**Capacitor Characteristics**

Ceramic composition capacitors are highly recommended over all other types of capacitors for use with the AAT3112. Ceramic capacitors offer many advantages over their tantalum and aluminum electrolytic counterparts. A ceramic capacitor typically has very low ESR, is lowest cost, has a smaller PCB footprint, and is non-polarized. Low ESR ceramic capacitors help to maximize charge pump transient response. Since ceramic capacitors are non-polarized, they are not prone to incorrect connection damage.

**Equivalent Series Resistance:** ESR is an important characteristic to consider when selecting a capacitor. ESR is a resistance internal to a capacitor that is caused by the leads, internal connections, size or area, material composition, and ambient temperature. Capacitor ESR is typically measured in milliohms for ceramic capacitors and can range to more than several ohms for tantalum or aluminum electrolytic capacitors.

**Ceramic Capacitor Materials:** Ceramic capacitors less than 0.1 $\mu$ F are typically made from NPO or COG materials. NPO and COG materials typically have tight tolerance and are stable over temperature. Large capacitor values are typically composed of X7R, X5R, Z5U, or Y5V dielectric materials. Large ceramic capacitors, typically greater than 2.2 $\mu$ F, are often available in low-cost Y5V and Z5U dielectrics, but large capacitors are not required in AAT3112 applications.

Capacitor area is another contributor to ESR. Capacitors that are physically large will have a lower ESR when compared to an equivalent material smaller capacitor. These larger devices can improve circuit transient response when compared to an equal value capacitor in a smaller package size.

**Layout Considerations**

High charge pump switching frequencies and large peak transient currents mandate careful printed circuit board layout. As a general rule for charge pump boost converters, all external capacitors should be located as closely as possible to the device package with minimum length trace connections.

Maximize the ground plane around the AAT3112 charge pump and make sure all external capacitors are connected to the immediate ground plane. A local component side ground plane is recommended.



## 500mA High Efficiency Charge Pump for White LED Flash Applications

### Application Circuits

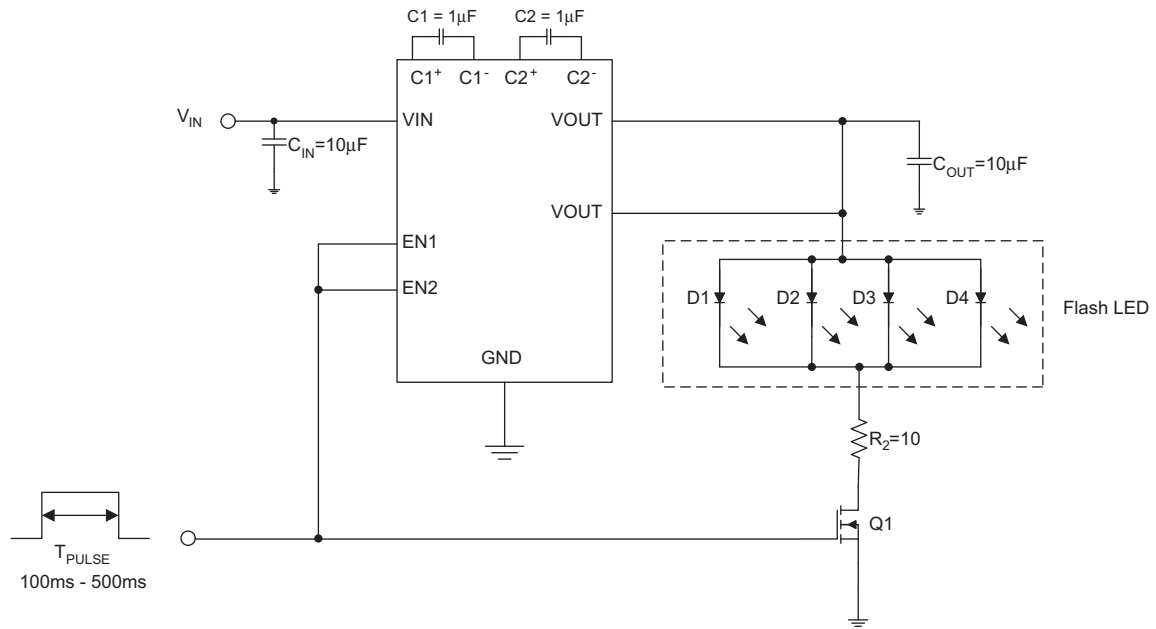

Figure 1: Flash Application.

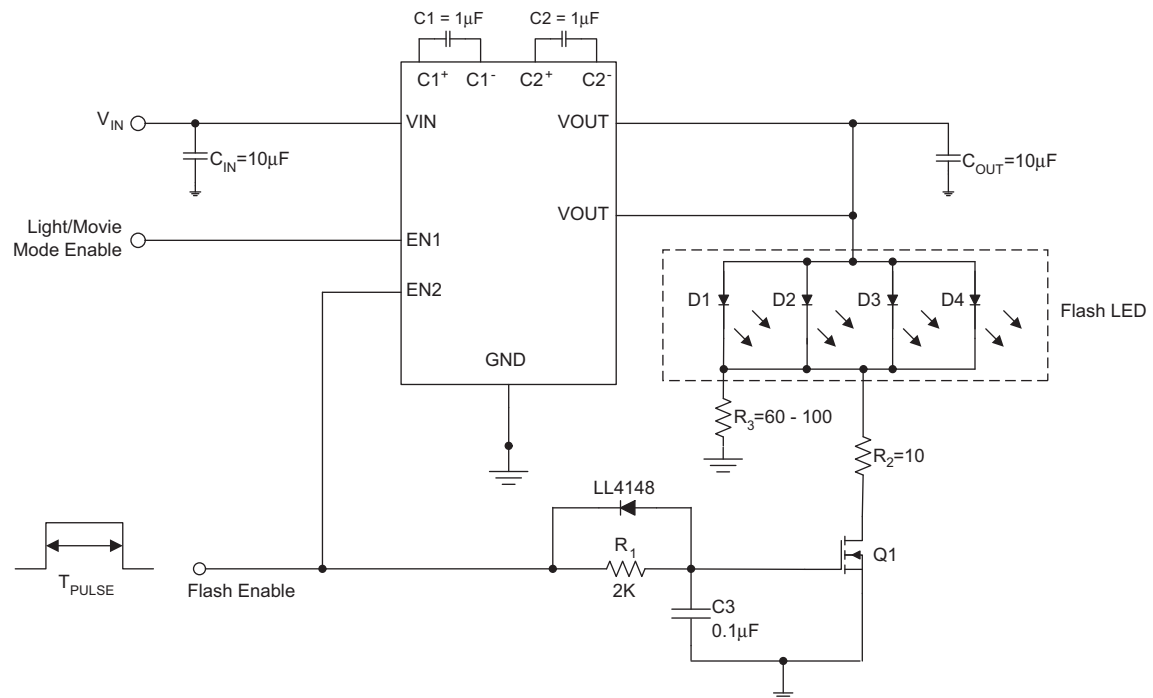

Figure 2: Movie Mode Light with Flash Function.

# AAT3112

## 500mA High Efficiency Charge Pump for White LED Flash Applications

### Ordering Information

Package	Marking <sup>1</sup>	Part Number (Tape and Reel) <sup>2</sup>
QFN33-16	LGXYY	<b>AAT3112IVN-4.5-T1</b>
QFN33-16	MNXYY	<b>AAT3112IVN-5.0-T1</b>



Skyworks Green™ products are compliant with all applicable legislation and are halogen-free.



For additional information, refer to *Skyworks Definition of Green™*, document number SQ04-0074.

### Package Information<sup>3</sup>

#### QFN33-16

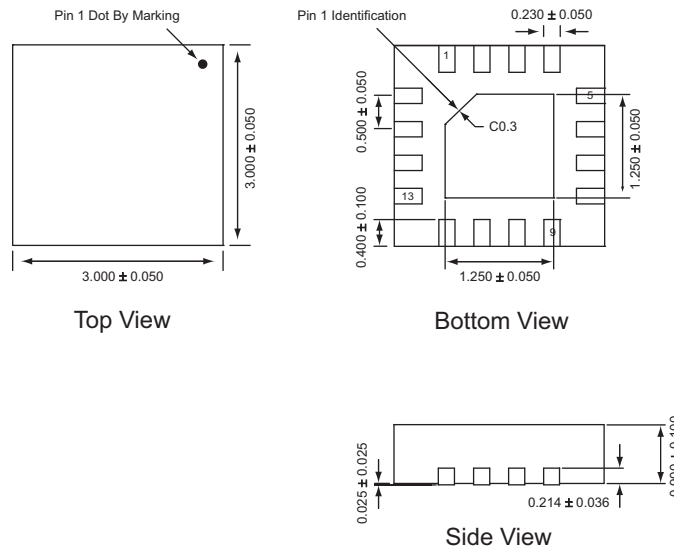

All dimensions in millimeters.

1. XYY = assembly and date code.
2. Sample stock is held on part numbers listed in **BOLD**.
3. The leadless package family, which includes QFN, TQFN, DFN, TDFN and STDFN, has exposed copper (unplated) at the end of the lead terminals due to the manufacturing process. A solder fillet at the exposed copper edge cannot be guaranteed and is not required to ensure a proper bottom solder connection.

Copyright © 2012 Skyworks Solutions, Inc. All Rights Reserved.

Information in this document is provided in connection with Skyworks Solutions, Inc. ("Skyworks") products or services. These materials, including the information contained herein, are provided by Skyworks as a service to its customers and may be used for informational purposes only by the customer. Skyworks assumes no responsibility for errors or omissions in these materials or the information contained herein. Skyworks may change its documentation, products, services, specifications or product descriptions at any time, without notice. Skyworks makes no commitment to update the materials or information and shall have no responsibility whatsoever for conflicts, incompatibilities, or other difficulties arising from any future changes.

No license, whether express, implied, by estoppel or otherwise, is granted to any intellectual property rights by this document. Skyworks assumes no liability for any materials, products or information provided hereunder, including the sale, distribution, reproduction or use of Skyworks products, information or materials, except as may be provided in Skyworks Terms and Conditions of Sale.

THE MATERIALS, PRODUCTS AND INFORMATION ARE PROVIDED "AS IS" WITHOUT WARRANTY OF ANY KIND, WHETHER EXPRESS, IMPLIED, STATUTORY, OR OTHERWISE, INCLUDING FITNESS FOR A PARTICULAR PURPOSE OR USE, MERCHANTABILITY, PERFORMANCE, QUALITY OR NON-INFRINGEMENT OF ANY INTELLECTUAL PROPERTY RIGHT; ALL SUCH WARRANTIES ARE HEREBY EXPRESSLY DISCLAIMED. SKYWORKS DOES NOT WARRANT THE ACCURACY OR COMPLETENESS OF THE INFORMATION, TEXT, GRAPHICS OR OTHER ITEMS CONTAINED WITHIN THESE MATERIALS. SKYWORKS SHALL NOT BE LIABLE FOR ANY DAMAGES, INCLUDING BUT NOT LIMITED TO ANY SPECIAL, INDIRECT, INCIDENTAL, STATUTORY, OR CONSEQUENTIAL DAMAGES, INCLUDING WITHOUT LIMITATION, LOST REVENUES OR LOST PROFITS THAT MAY RESULT FROM THE USE OF THE MATERIALS OR INFORMATION, WHETHER OR NOT THE RECIPIENT OF MATERIALS HAS BEEN ADVISED OF THE POSSIBILITY OF SUCH DAMAGE.

Skyworks products are not intended for use in medical, lifesaving or life-sustaining applications, or other equipment in which the failure of the Skyworks products could lead to personal injury, death, physical or environmental damage. Skyworks customers using or selling Skyworks products for use in such applications do so at their own risk and agree to fully indemnify Skyworks for any damages resulting from such improper use or sale.

Customers are responsible for their products and applications using Skyworks products, which may deviate from published specifications as a result of design defects, errors, or operation of products outside of published parameters or design specifications. Customers should include design and operating safeguards to minimize these and other risks. Skyworks assumes no liability for applications assistance, customer product design, or damage to any equipment resulting from the use of Skyworks products outside of stated published specifications or parameters.

Skyworks, the Skyworks symbol, and "Breakthrough Simplicity" are trademarks or registered trademarks of Skyworks Solutions, Inc., in the United States and other countries. Third-party brands and names are for identification purposes only, and are the property of their respective owners. Additional information, including relevant terms and conditions, posted at [www.skyworksinc.com](http://www.skyworksinc.com), are incorporated by reference.