



Chipsmall Limited consists of a professional team with an average of over 10 year of expertise in the distribution of electronic components. Based in Hongkong, we have already established firm and mutual-benefit business relationships with customers from,Europe,America and south Asia,supplying obsolete and hard-to-find components to meet their specific needs.

With the principle of “Quality Parts,Customers Priority,Honest Operation,and Considerate Service”,our business mainly focus on the distribution of electronic components. Line cards we deal with include Microchip,ALPS,ROHM,Xilinx,Pulse,ON,Everlight and Freescale. Main products comprise IC,Modules,Potentiometer,IC Socket,Relay,Connector.Our parts cover such applications as commercial,industrial, and automotives areas.

We are looking forward to setting up business relationship with you and hope to provide you with the best service and solution. Let us make a better world for our industry!



## Contact us

Tel: +86-755-8981 8866 Fax: +86-755-8427 6832

Email & Skype: info@chipsmall.com Web: www.chipsmall.com

Address: A1208, Overseas Decoration Building, #122 Zhenhua RD., Futian, Shenzhen, China



**300mA LDO Linear Regulator with  $\mu$ P Reset**

**General Description**

The AAT3258 combines a high performance, low noise, 300mA low dropout (LDO) linear regulator with a microprocessor reset monitor. The 300mA output capability of the LDO regulator makes this device ideal for use with microprocessors and DSP cores in portable products. The microprocessor reset monitor section has very low quiescent current consumption and has an active low reset output. The AAT3258 has separate input pins for the reset monitor and LDO regulator so they may be operated from independent sources for increased design flexibility. This device features very low quiescent current, typically less than 71 $\mu$ A.

The LDO regulator has low dropout voltage, typically 400mV at the full output current level, making it ideal for portable applications where extended battery life is critical. The AAT3258 LDO regulator section has complete over-current/short-circuit and over-temperature protection circuits to guard against extreme operating conditions. The device also has an active output pull-down function when disabled.

The AAT3258 is available in a Pb-free, space-saving 8-pin TSOPJW package. This device is capable of operation over a -40°C to +85°C temperature range.

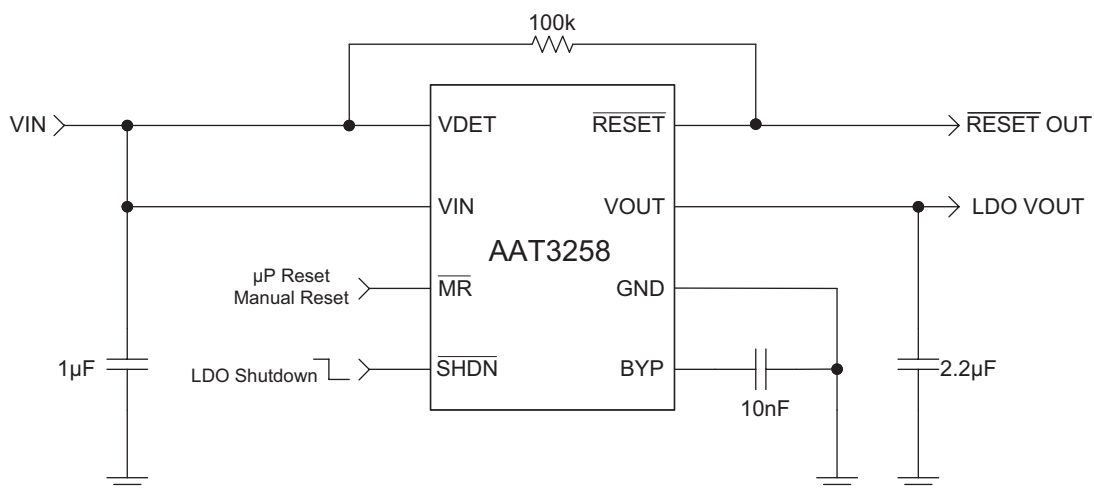
**Features**

- Integrated LDO Regulator with  $\mu$ P Reset
- 300mA Output LDO Regulator
- Low Dropout Regulator, 400mV at 300mA
- High LDO Output Voltage Accuracy, Typically 1.5%
- Very Low Noise and High Power Supply Rejection Ratio (PSRR) LDO
- Low Quiescent Current at 71 $\mu$ A
- LDO Over-Current/Short-Circuit Protection
- LDO Over-Temperature Protection
- LDO Power Saving Shutdown Mode
- Independent Device Power Inputs
- High Accuracy Reset Monitor Threshold:  $\pm$ 1.5%
- Active Low Push-Pull Monitor Reset Output
- <2.0 $\mu$ A of Shutdown Current
- Uses Low Equivalent Series Resistance (ESR) Ceramic Capacitors
- -40°C to +85°C Temperature Range
- 8-Pin TSOPJW Package

**Applications**

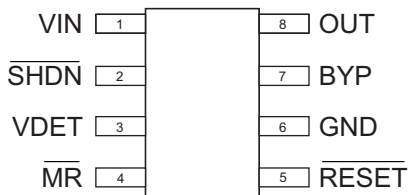
- Cellular Phones
- Digital Cameras
- Handheld Instrumentation
- Microprocessor/DSP Core/IO Power
- Notebook Computers
- PDAs and Handheld Computers
- Portable Communication Devices

**Typical Application**



**AAT3258****300mA LDO Linear Regulator with  $\mu$ P Reset****Pin Descriptions**

Pin #	Symbol	Function
1	VIN	LDO voltage regulator input pin. This pin should be decoupled with 1 $\mu$ F or greater capacitor. See application information.
2	$\overline{\text{SHDN}}$	LDO voltage regulator shutdown pin. This pin should not be left floating. When connected low, all the internal circuitry is powered down. When high, it is in normal operation.
3	VDET	Microprocessor reset input power supply pin. It may be connected to V <sub>IN</sub> .
4	$\overline{\text{MR}}$	Manual reset active low input. A logic low signal on $\overline{\text{MR}}$ asserts a reset condition. Asserted reset continues as long as $\overline{\text{MR}}$ is low and for a minimum of 150ms after $\overline{\text{MR}}$ returns high.
5	$\overline{\text{RESET}}$	Reset output remains low while V <sub>DET</sub> is below the reset threshold and remains so for a minimum of 150ms after V <sub>DET</sub> rises above the reset threshold.
6	GND	Ground connection pin.
7	BYP	LDO voltage regulator bypass capacitor connection. To improve AC ripple rejection and decrease LDO regulator self noise, connect a 10nF ceramic capacitor between this pin and GND.
8	OUT	LDO voltage regulator output pin; should be decoupled with a 2.2 $\mu$ F or greater value low ESR ceramic capacitor.

**Pin Configuration****TSOPJW-8  
(Top View)**

**300mA LDO Linear Regulator with  $\mu$ P Reset****Absolute Maximum Ratings<sup>1</sup>**

$T_A = 25^\circ\text{C}$ , unless otherwise noted.

Symbol	Description	Value	Units
$V_{IN}$	Input Voltage	6.0	V
$V_{RESET}$	RESET to GND	-0.3 to $V_{DET} + 0.3$	V
$V_{SHDNIN(MAX)}$	Maximum $\overline{SHDN}$ to Input Voltage	0.3	V
$I_{OUT}$	LDO Regulator DC Output Current	$P_D / (V_{IN} - V_O)$	mA
$I_{RESET}$	Maximum Reset Output Current	20	mA
$\Delta V_{DET}/\Delta t$	Maximum Rate of $V_{DET}$ Rise	100	V/ $\mu$ s
$T_J$	Operating Junction Temperature Range	-40 to 150	$^\circ\text{C}$

**Thermal Information<sup>2</sup>**

Symbol	Description	Value	Units
$\theta_{JA}$	Maximum Thermal Resistance	150	$^\circ\text{C}/\text{W}$
$P_D$	Maximum Power Dissipation	833	mW

**Recommended Operating Conditions**

Symbol	Description	Value	Units
$V_{IN}$	Input Voltage to LDO <sup>3</sup>	$(V_{OUT} + V_{DO})$ to 5.5	V
$V_{DET}$	Input Voltage to $\mu$ P Reset ( $0^\circ$ to $70^\circ\text{C}$ )	1.0 to 5.5	V
$T$	Ambient Temperature Range	-40 to +85	$^\circ\text{C}$

1. Stresses above those listed in Absolute Maximum Ratings may cause permanent damage to the device. Functional operation at conditions other than the operating conditions specified is not implied. Only one Absolute Maximum Rating should be applied at any one time.

2. Mounted on a demo board.

3. To calculate minimum input voltage, use the following equation:  $V_{IN(MIN)} = V_{OUT(MAX)} + V_{DO(MAX)}$  as long as  $V_{IN} \geq 2.5\text{V}$ .

**300mA LDO Linear Regulator with  $\mu$ P Reset**

**Electrical Characteristics<sup>1</sup>**

$T_J = 25^\circ\text{C}$ , unless otherwise noted.

Symbol	Description	Conditions	Min	Typ	Max	Units	
<b>300mA LDO Regulator</b>							
$V_{OUT}$	Output Voltage	$I_{OUT} = 1\text{mA}$ to 300mA	$T_A = 25^\circ\text{C}$	-1.5		1.5	%
			$T_A = -40^\circ\text{C}$ to $85^\circ\text{C}$	-2.5		2.5	
$I_{OUT}$	Output Current	$V_{OUT} > 1.2\text{V}$		300		mA	
$I_{SC}$	Short-Circuit Current	$V_{OUT} < 0.4\text{V}$		600		mA	
$I_{GND}$	Ground Current	$V_{IN} = 5\text{V}$ , No Load, $\text{SHDN} = V_{IN}$		70	125	$\mu\text{A}$	
$I_{SHDN}$	Shutdown Current	$V_{IN} = 5\text{V}$ , $\text{SHDN} = 0\text{V}$			1.0	$\mu\text{A}$	
$\Delta V_{OUT}/V_{OUT} \cdot \Delta V_{IN}$	Line Regulation	$V_{IN} = V_{OUT} + 1$ to $5.0\text{V}$			0.09	%/V	
$\Delta V_{OUT}$ (line)	Dynamic Line Regulation	$I_{OUT} = 300\text{mA}$ , $T_R/T_F = 2\mu\text{s}$ , $V_{IN} = V_{OUT} + 1\text{V}$ to $V_{OUT} + 2\text{V}$		2.5		mV	
$V_{OUT}$ (load)	Dynamic Load Regulation	$I_{OUT} = 1\text{mA}$ to $300\text{mA}$ , $T_R < 5\mu\text{s}$		60		mV	
$T_{ENDLY}$	Enable Delay Time	$\text{BYP} = \text{Open}$		15		$\mu\text{s}$	
$V_{DO}$	Dropout Voltage <sup>2</sup>	$I_{OUT} = 300\text{mA}$		400	600	mV	
$V_{IL}$	Input Low Voltage				0.6	V	
$V_{IH}$	Input High Voltage		1.5			V	
$I_{IL}$	Input Low Current				1.0	$\mu\text{A}$	
$I_{IH}$	Input High Current				1.0	$\mu\text{A}$	
PSRR	Power Supply Rejection Ratio	$I_{OUT} = 10\text{mA}$ , $C_{BYP} = 10\text{nF}$	1kHz	67		dB	
			10kHz	47			
			100kHz	45			
$T_{SD}$	Over-Temperature Shutdown Threshold			145		$^\circ\text{C}$	
$T_{HYS}$	Over-Temperature Shutdown Hysteresis			12		$^\circ\text{C}$	
$e_N$	Output Noise			50		$\mu\text{V}_{RMS}$	
TC	Output Voltage Temperature Coefficient			22		ppm/ $^\circ\text{C}$	
<b>Microprocessor Reset Monitor</b>							
$V_{DET}$	Input Voltage Range	$T_A = 0^\circ\text{C}$ to $+70^\circ\text{C}$	1		5.5	V	
		$T_A = -40^\circ\text{C}$ to $+85^\circ\text{C}$	1.2		5.5		
$I_Q$	Quiescent Current	$V_{CC} = 5.5\text{V}$		1.05	3.0	$\mu\text{A}$	
		$V_{CC} = 3.0\text{V}$		0.85	2.0		
$I_{DD}$	Operating Supply Current	$V_{DET} = 3.0\text{V}$		0.85	2.0	$\mu\text{A}$	
$I_{DOFF}$	Reset Leakage Current	$V_{DET} > V_{TH}$			1.0	$\mu\text{A}$	
$V_{TH}$	Reset Threshold Voltage	$T_A = 25^\circ\text{C}$	AAT3258xxx-x.x-R	2.59	2.63	2.67	V
			AAT3258xxx-x.x-Y	2.41	2.45	2.49	
$\Delta V_{TH}/^\circ\text{C}$	Reset Threshold Tempco			40		ppm/ $^\circ\text{C}$	
$T_P$	Reset Propagation Delay	$V_{DET} = V_{TH}$ to $(V_{TH} - 100\text{mV})$		15		$\mu\text{s}$	
$T_{RDY}$	Reset Active Timeout Period		150	250	400	ms	
$T_{MR}$	MR Minimum Pulse Width		10			$\mu\text{s}$	
MRGI	MR Glitch Immunity			100		ns	
$R_{MR}$	MR Pull-Up Resistance		30	65	90	$\text{k}\Omega$	
$T_{MD}$	MR to Reset Propagation Delay			0.5		$\mu\text{s}$	
$V_{IH}$	MR Input Threshold (high)	$V_{DET} = V_{TH(MAX)}$	0.7 · $V_{DET}$			V	
$V_{IL}$	MR Input Threshold (low)	$V_{DET} = V_{TH(MAX)}$			0.25 · $V_{DET}$	V	
$V_{OL}$	Reset Low Voltage	$I_{SINK} = 1.2\text{mA}$ , $V_{DET} = V_{TH(MIN)}$ , $V_{TH} \leq 3.08\text{V}$ , Reset Asserted			0.3	V	
		$I_{SINK} = 3.2\text{mA}$ , $V_{DET} = V_{TH(MIN)}$ , $V_{TH} > 3.08\text{V}$ , Reset Asserted			0.4		
$V_{OH}$	Reset High Voltage	$I_{SOURCE} = 800\mu\text{A}$ , $V_{DET} > 3.08\text{V}$ , $V_{DET} > V_{TH(MAX)}$	$V_{DET} - 1.5$			V	
		$I_{SOURCE} = 500\mu\text{A}$ , $V_{DET} > V_{TH(MAX)}$ , $V_{TH} \leq 3.08\text{V}$	0.8 · $V_{DET}$				

1. The AAT3258 is guaranteed to meet performance specifications over the  $-40^\circ\text{C}$  to  $85^\circ\text{C}$  operating temperature range and is assured by design, characterization, and correlation with statistical process controls.

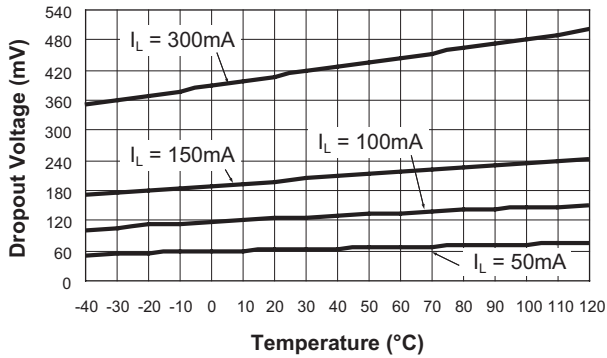
2.  $V_{DO}$  is defined as  $V_{IN} - V_{OUT}$  when  $V_{OUT}$  is 98% of nominal.

## 300mA LDO Linear Regulator with $\mu P$ Reset

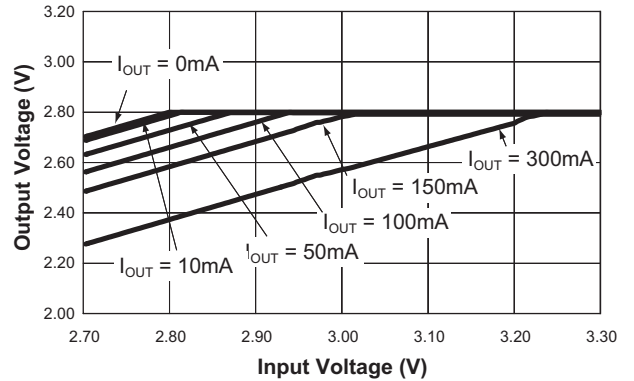
### Typical Characteristics

Unless otherwise noted,  $V_{IN} = 5V$ ,  $T_A = 25^\circ C$ .

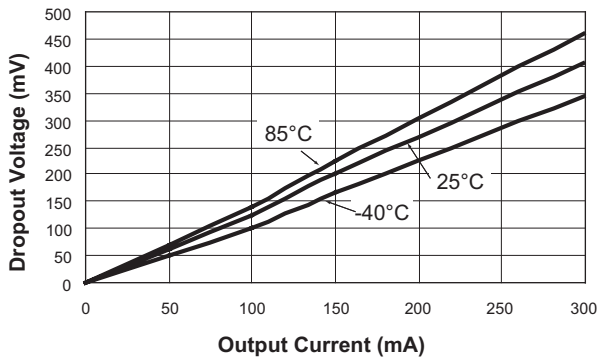
**Dropout Voltage vs. Temperature**



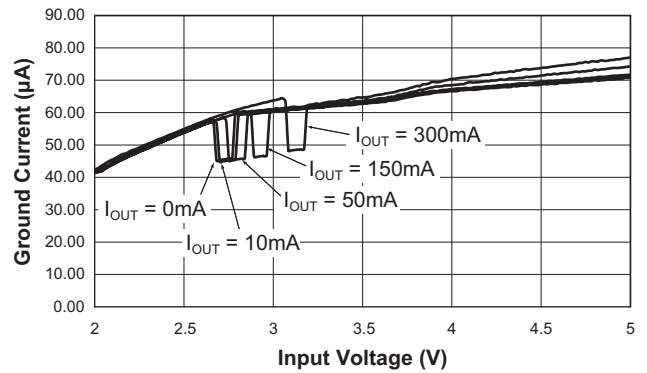
**Dropout Characteristics**



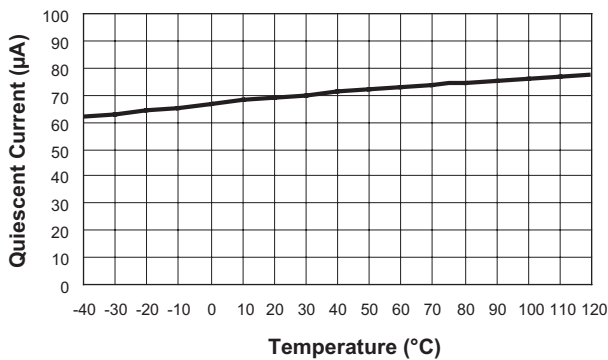
**Dropout Voltage vs. Output Current**



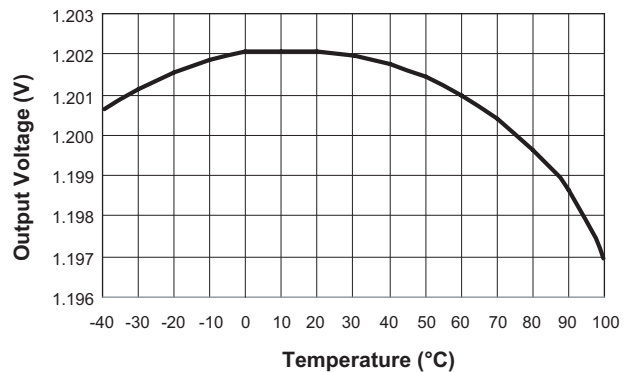
**Ground Current vs. Input Voltage**



**Quiescent Current vs. Temperature**



**Output Voltage vs. Temperature**



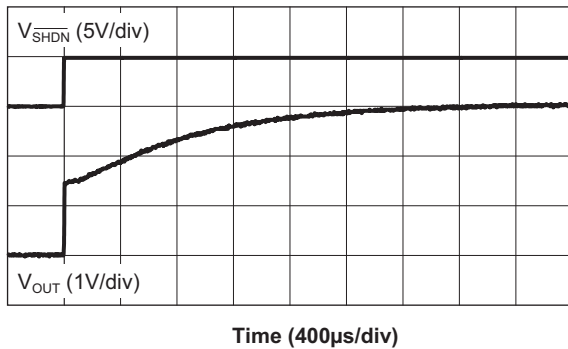
# AAT3258

## 300mA LDO Linear Regulator with $\mu P$ Reset

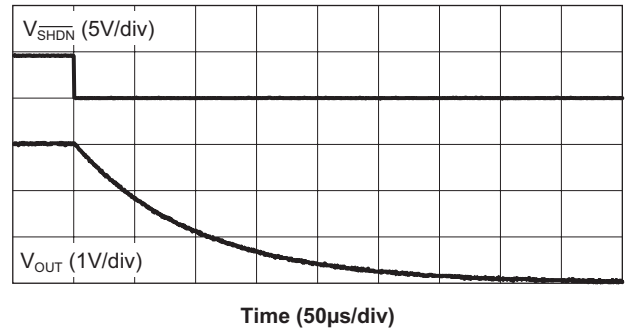
### Typical Characteristics

Unless otherwise noted,  $V_{IN} = 5V$ ,  $T_A = 25^\circ C$ .

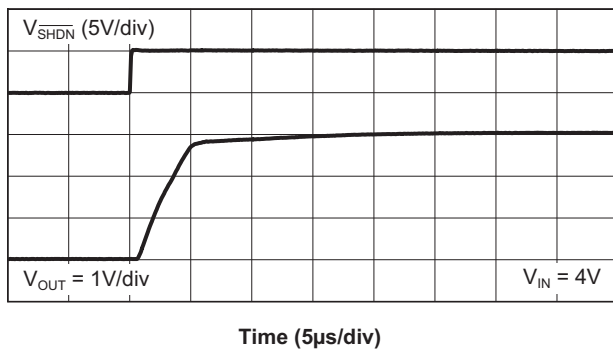
**Initial Power-Up Response Time**  
( $C_{BYP} = 10nF$ )



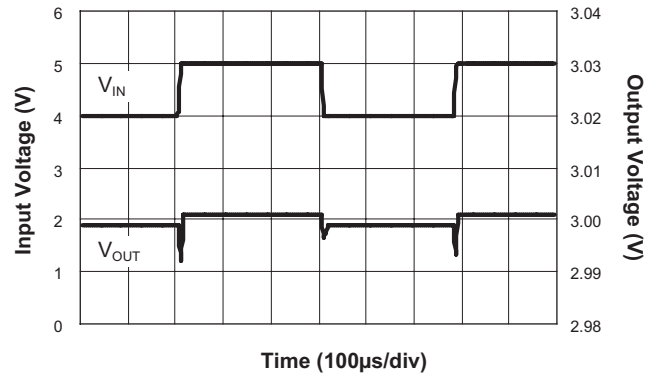
**Turn-Off Response Time**  
( $C_{BYP} = 10nF$ )



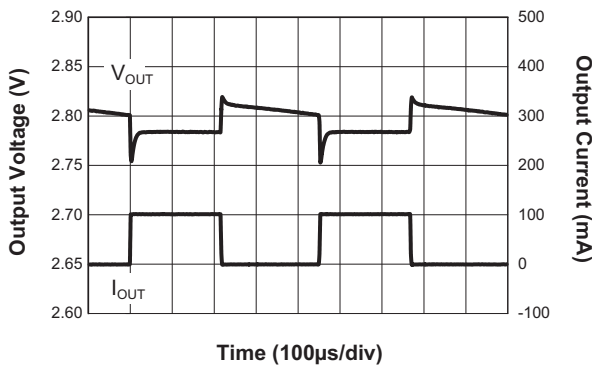
**Turn-On Time From Enable ( $V_{IN}$  present)**  
( $C_{BYP} = 10nF$ )



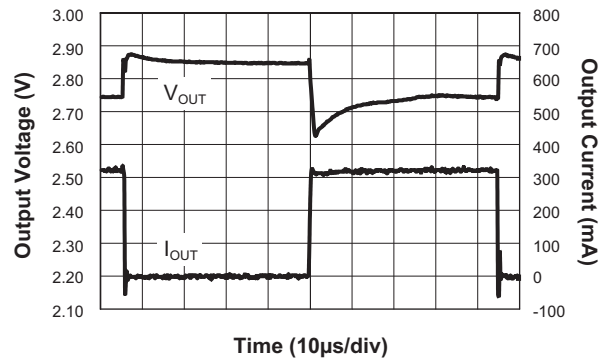
**Line Transient Response**



**Load Transient Response**



**Load Transient Response 300mA**



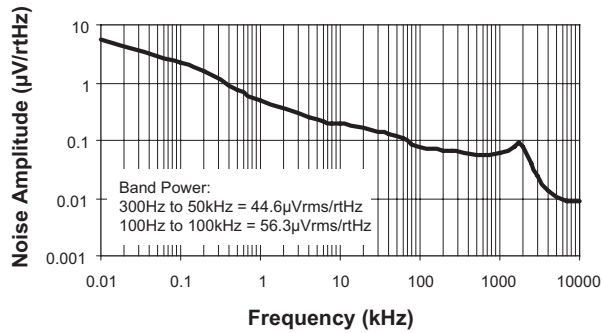
# AAT3258

## 300mA LDO Linear Regulator with $\mu P$ Reset

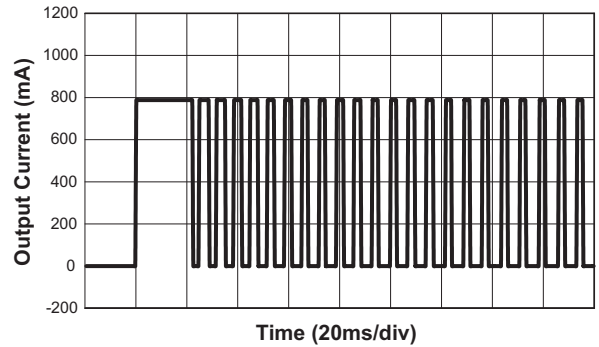
### Typical Characteristics

Unless otherwise noted,  $V_{IN} = 5V$ ,  $T_A = 25^\circ C$ .

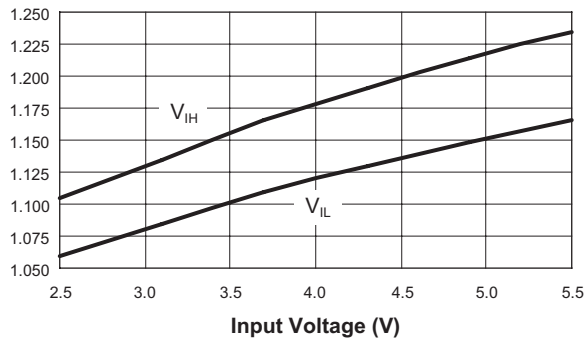
**AAT3258 Self Noise**  
( $C_{OUT} = 10\mu F$ , ceramic)



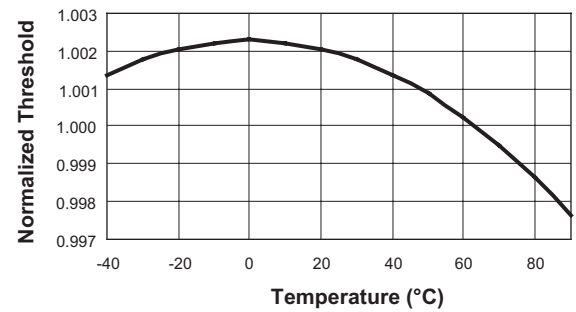
**Over-Current Protection**



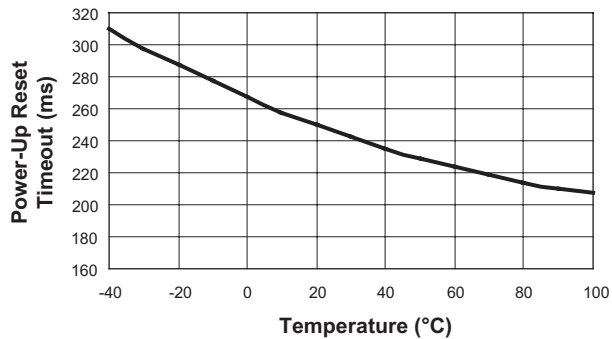
**LDO SHDN  $V_{IH}$  and  $V_{IL}$  vs.  $V_{IN}$**



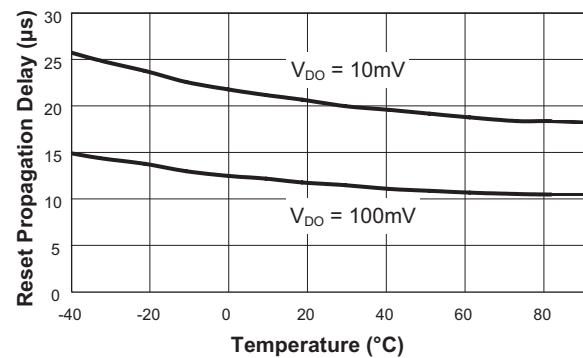
**Normalized Reset Threshold vs. Temperature**



**Power-Up Reset Timeout vs. Temperature**

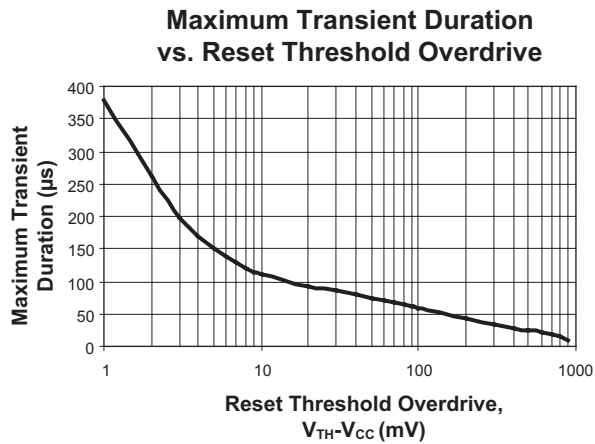


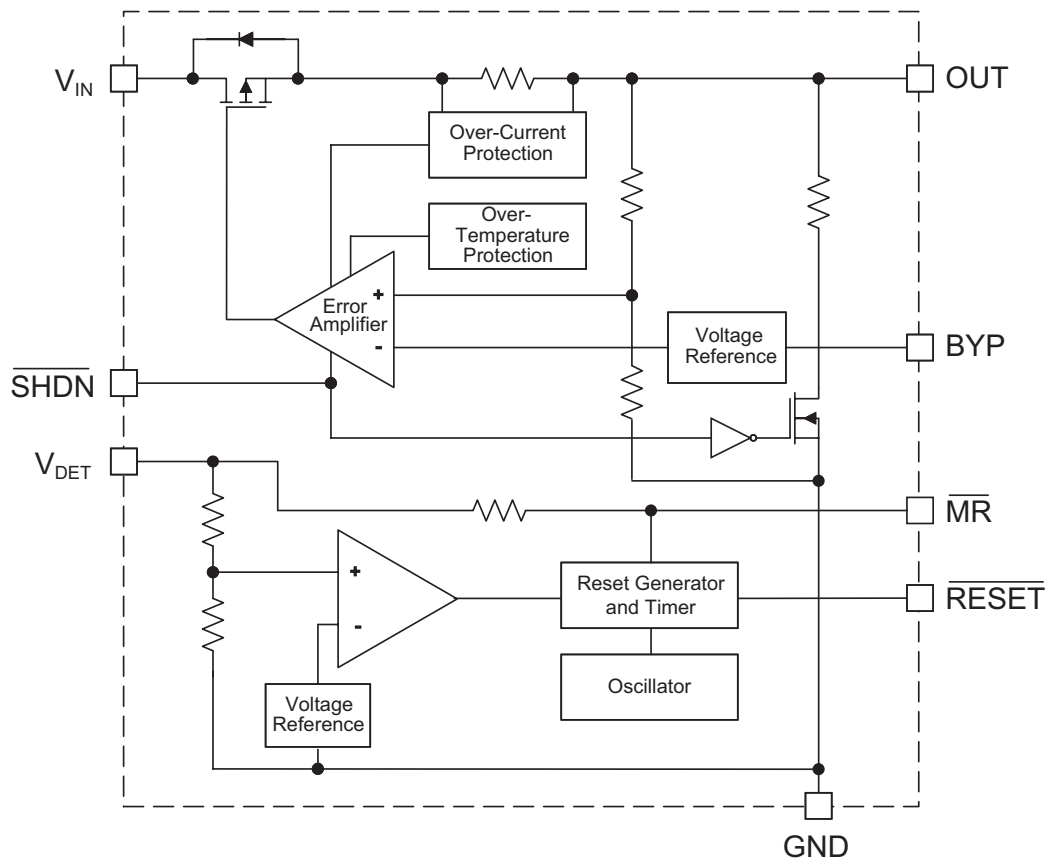
**Power-Down Reset Propagation Delay vs. Temperature**



## Typical Characteristics

Unless otherwise noted,  $V_{IN} = 5V$ ,  $T_A = 25^\circ C$ .



**Functional Block Diagram****Functional Description**

The AAT3258 is intended for LDO regulator applications where output current load requirements range from no load to 300mA.

The advanced circuit design of the AAT3258 has been specifically optimized for very fast start-up and shutdown timing. This proprietary CMOS LDO has also been tailored for superior transient response characteristics. These traits are particularly important for applications that require fast power supply timing, such as GSM cellular telephone handsets.

The high-speed turn-on capability is enabled through the implementation of a fast start control circuit, which accelerates the power-up behavior of fundamental control and feedback circuits within the LDO regulator.

Fast turn-off response time is achieved by an active output pull-down circuit, which is enabled when the LDO regulator is placed in the shutdown mode. This active fast shutdown circuit has no adverse effect on normal device operation.

The AAT3258 has very fast transient response characteristics, which is an important feature for applications where fast line and load transient response is required. This rapid transient response behavior is accomplished through the implementation of an active error amplifier feedback control. This proprietary circuit design is unique to this MicroPower LDO regulator.

The LDO regulator output has been specifically optimized to function with low-cost, low-ESR ceramic capacitors; however, the design will allow for operation over a wide range of capacitor types.

**300mA LDO Linear Regulator with  $\mu$ P Reset**

**LDO Regulator Applications**

**Input Capacitor**

Typically, a  $1\mu\text{F}$  or larger capacitor is recommended for  $C_{\text{IN}}$  in most applications. A  $C_{\text{IN}}$  capacitor is not required for basic LDO regulator operation. However, if the AAT3258 is physically located more than three centimeters from an input power source, a  $C_{\text{IN}}$  capacitor will be needed for stable operation.  $C_{\text{IN}}$  should be located as closely to the device  $V_{\text{IN}}$  pin as practically possible.  $C_{\text{IN}}$  values greater than  $1\mu\text{F}$  will offer superior input line transient response and will assist in maximizing the highest possible power supply ripple rejection.

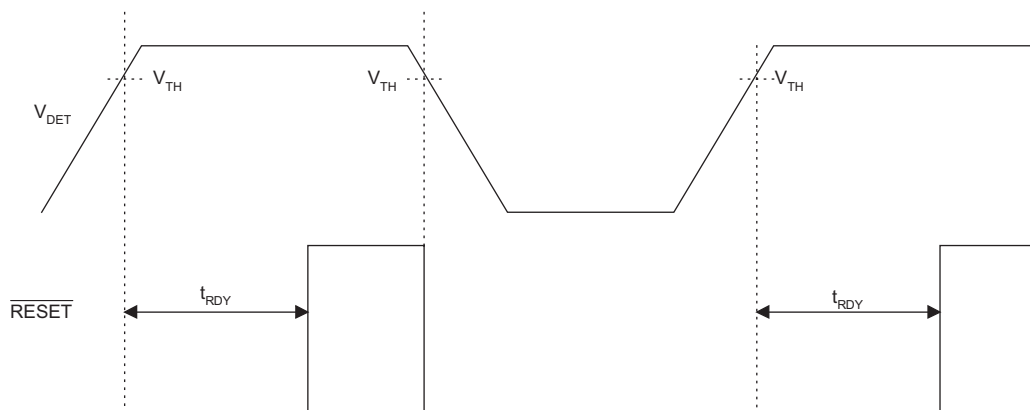
Ceramic, tantalum, or aluminum electrolytic capacitors may be selected for  $C_{\text{IN}}$ . There is no specific capacitor ESR requirement for  $C_{\text{IN}}$ . However, for 300mA LDO regulator output operation, ceramic capacitors are recommended for  $C_{\text{IN}}$  due to their inherent capability over tantalum capacitors to withstand input current surges from low impedance sources such as batteries in portable devices.

A bypass pin has been provided to allow the addition of an optional voltage reference bypass capacitor to reduce output self noise and increase power supply ripple rejection. Device self noise and PSRR will be improved by the addition of a small ceramic capacitor in this pin. However, increased values of  $C_{\text{BYPASS}}$  may slow down the LDO regulator turn-on time.

This LDO regulator has complete short-circuit and thermal protection. The integral combination of these two internal protection circuits gives the AAT3258 a comprehensive safety system to guard against extreme adverse operating conditions. Device power dissipation is limited to the package type and thermal dissipation properties. Refer to the Thermal Considerations section of this datasheet for details on device operation at maximum output current loads.

The microprocessor reset section monitors the supply voltage to a microprocessor and asserts a reset signal whenever the  $V_{\text{DET}}$  voltage falls below a factory-programmed threshold. This threshold is accurate within  $\pm 1.5\%$  at  $25^\circ\text{C}$ . The reset signal remains asserted for a minimum of 150ms after  $V_{\text{DET}}$  has risen above the threshold, as shown in Figure 1.

To assure the maximum possible performance is obtained from the AAT3258, please refer to the following application recommendations.



**Figure 1: Reset Signal Assertion.**

**300mA LDO Linear Regulator with  $\mu$ P Reset****Output Capacitor**

For proper load voltage regulation and operational stability, a capacitor is required between pins  $V_{OUT}$  and GND. The  $C_{OUT}$  capacitor connection to the LDO regulator ground pin should be made as direct as practically possible for maximum device performance.

The AAT3258 has been specifically designed to function with very low ESR ceramic capacitors. For best performance, ceramic capacitors are recommended.

Typical output capacitor values for maximum output current conditions range from  $1\mu\text{F}$  to  $10\mu\text{F}$ . Applications utilizing the exceptionally low output noise and optimum power supply ripple rejection characteristics of the AAT3258 should use  $2.2\mu\text{F}$  or greater for  $C_{OUT}$ . If desired,  $C_{OUT}$  may be increased without limit.

In low output current applications where output load is less than 10mA, the minimum value for  $C_{OUT}$  can be as low as  $0.47\mu\text{F}$ .

**Bypass Capacitor and Low Noise Applications**

A bypass capacitor pin is provided to enhance the low noise characteristics of the AAT3258 LDO regulator. The bypass capacitor is not necessary for operation. However, for best device performance, a small ceramic capacitor should be placed between the bypass pin (BYP) and the device ground pin (GND). The value of  $C_{BYP}$  may range from 470pF to 10nF. For lowest noise and best possible power supply ripple rejection performance, a 10nF capacitor should be used. To practically realize the highest power supply ripple rejection and lowest output noise performance, it is critical that the capacitor connection between the BYP pin and GND pin be direct and PCB traces should be as short as possible. Refer to the Evaluation Board Layout section of this document for examples.

There is a relationship between the bypass capacitor value and the LDO regulator turn-on and turn-off time. In applications where fast device turn-on and turn-off time are desired, the value of  $C_{BYP}$  should be reduced.

In applications where low noise performance and/ or ripple rejection are less of a concern, the bypass capacitor may be omitted. The fastest device turn-on time will be realized when no bypass capacitor is used.

DC leakage on this pin can affect the LDO regulator output noise and voltage regulation performance. For this reason, the use of a low leakage, high quality, ceramic (NPO or COG type) or film capacitor is highly recommended.

**Capacitor Characteristics**

Ceramic composition capacitors are highly recommended over all other types of capacitors. Ceramic capacitors offer many advantages over their tantalum and aluminum electrolytic counterparts. A ceramic capacitor typically has very low ESR, is lower cost, has a smaller PCB footprint, and is non-polarized. Line and load transient response of the LDO regulator is improved by using low ESR ceramic capacitors. Since ceramic capacitors are non-polarized, they are not prone to incorrect connection damage.

**Equivalent Series Resistance:** ESR is a very important characteristic to consider when selecting a capacitor. ESR is the internal series resistance associated with a capacitor that includes lead resistance, internal connections, size and area, material composition, and ambient temperature. Typically, capacitor ESR is measured in milliohms for ceramic capacitors and can range to more than several ohms for tantalum or aluminum electrolytic capacitors.

**Ceramic Capacitor Materials:** Ceramic capacitors less than  $0.1\mu\text{F}$  are typically made from NPO or COG materials. NPO and COG materials generally have tight tolerance and are very stable over temperature. Larger capacitor values are usually composed of X7R, X5R, Z5U, or Y5V dielectric materials. These two material types are not recommended for use with LDO regulators since the capacitor tolerance can vary more than  $\pm 50\%$  over the operating temperature range of the device. A  $2.2\mu\text{F}$  Y5V capacitor could be reduced to  $1\mu\text{F}$  over temperature; this could cause problems for circuit operation. X7R and X5R dielectrics are much more desirable. The temperature tolerance of X7R dielectric is better than  $\pm 15\%$ .

**300mA LDO Linear Regulator with  $\mu$ P Reset**

Capacitor area is another contributor to ESR. Capacitors that are physically large in size will have a lower ESR when compared to a smaller sized capacitor of an equivalent material and capacitance value. These larger devices can improve circuit transient response when compared to an equal value capacitor in a smaller package size.

Consult capacitor vendor datasheets carefully when selecting capacitors for LDO regulators.

**Shutdown Function**

The shutdown pin is designed to turn off the LDO regulator when the device is not in use. This pin is active high and is compatible with CMOS logic. To assure the LDO regulator will switch on, the  $\overline{\text{SHDN}}$  turn-on control level must be greater than 1.5V. The LDO regulator will go into the disable shutdown mode when the voltage falls below 0.6V. If the shutdown function is not needed in a specific application, it may be tied to  $V_{\text{IN}}$  to keep the LDO regulator in a continuously on state.

When the LDO regulator is in the shutdown mode, an internal 1.5k $\Omega$  resistor is connected between  $V_{\text{OUT}}$  and GND. This is intended to discharge  $C_{\text{OUT}}$  when the LDO regulator is disabled. The internal 1.5k $\Omega$  has no adverse effect on device turn-on time.

**Short-Circuit Protection**

The LDO regulator section contains an internal short-circuit protection circuit that will trigger when the output load current exceeds the internal threshold limit. Under short-circuit conditions, the output of the LDO regulator will be current limited until the short-circuit condition is removed from the output or the LDO regulator package power dissipation exceeds the device thermal limit.

**Thermal Protection**

The AAT3258 has an internal thermal protection circuit which will turn on when the device die temperature exceeds 145°C. The internal thermal protection circuit

will actively turn off the LDO regulator output pass device to prevent the possibility of over-temperature damage. The LDO regulator output will remain in a shutdown state until the internal die temperature falls back below the 145°C trip point.

The combination and interaction between the short-circuit and thermal protection systems allows the LDO regulator to withstand indefinite short-circuit conditions without sustaining permanent damage.

**No-Load Stability**

The LDO regulator is designed to maintain output voltage regulation and stability under operational no-load conditions. This is an important characteristic for applications where the output current may drop to zero.

**Reverse Output-to-Input Voltage Conditions and Protection**

Under normal operating conditions, a parasitic diode exists between the output and input of the LDO regulator. The input voltage should always remain greater than the output load voltage, maintaining a reverse bias on the internal parasitic diode. Conditions where  $V_{\text{OUT}}$  might exceed  $V_{\text{IN}}$  should be avoided since this would forward bias the internal parasitic diode and allow excessive current flow into the  $V_{\text{OUT}}$  pin, possibly damaging the LDO regulator.

In applications where there is a possibility of  $V_{\text{OUT}}$  exceeding  $V_{\text{IN}}$  for brief amounts of time during normal operation, the use of a larger value  $C_{\text{IN}}$  capacitor is highly recommended. A larger value of  $C_{\text{IN}}$  with respect to  $C_{\text{OUT}}$  will effect a slower  $C_{\text{IN}}$  decay rate during shutdown, thus preventing  $V_{\text{OUT}}$  from exceeding  $V_{\text{IN}}$ . In applications where there is a greater danger of  $V_{\text{OUT}}$  exceeding  $V_{\text{IN}}$  for extended periods of time, it is recommended to place a Schottky diode across  $V_{\text{IN}}$  to  $V_{\text{OUT}}$  (connecting the cathode to  $V_{\text{IN}}$  and anode to  $V_{\text{OUT}}$ ). The Schottky diode forward voltage should be less than 0.45V.

## MicroPower Supervisory Circuit Applications

### Reset Output Options

The reset pin is an active low push-pull output. In the event of a power down or brown-out condition, the reset signal remains valid until the  $V_{DET}$  drops below 1.2V.

### Manual Reset Input

A logic low signal on  $\overline{MR}$  asserts a reset condition. Reset continues to be asserted as long as  $\overline{MR}$  is low and for a minimum of 150ms after  $\overline{MR}$  returns high. This input is internally pulled up to  $V_{CC}$  via a 20k $\Omega$  resistor, so leaving the pin unconnected is acceptable if a manual reset function is not needed. The  $\overline{MR}$  input is internally debounced, which allows use of a mechanical switch. It should be a normally-open momentary switch connected from  $\overline{MR}$  to GND. Additionally, the  $\overline{MR}$  pin can be driven from TTL, CMOS, or open drain logic outputs.

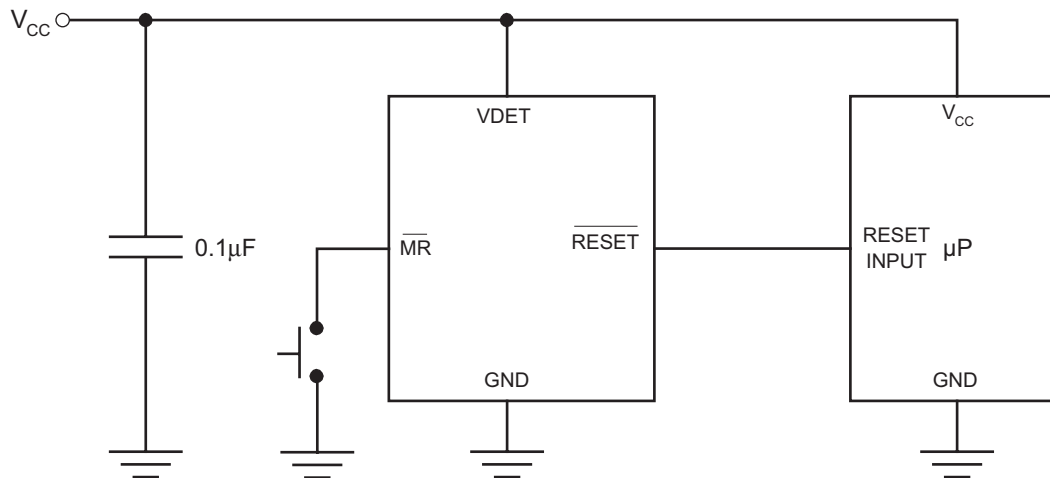
### Supply Voltage Transient Behavior

In some cases, fast negative transients of short duration can appear on the  $V_{CC}$  power supply. The AAT3258 series device provides some immunity to line transients which can generate invalid reset pulses. Figure 2 shows typical behavior of short duration pulses versus RESET comparator overdrive. As shown in the Maximum Transient Duration vs. Reset Threshold Overdrive graph, when the transient voltage becomes larger, the time allowed before asserting a reset becomes shorter (e.g., typically a transient of 100mV below the reset threshold would have to be present for more than 50 $\mu$ s to cause a reset). Immunity can be increased by the addition of a small bypass capacitor of 0.1 $\mu$ F connected as closely to the  $V_{CC}$  pin as possible.

### Evaluation Board Layout

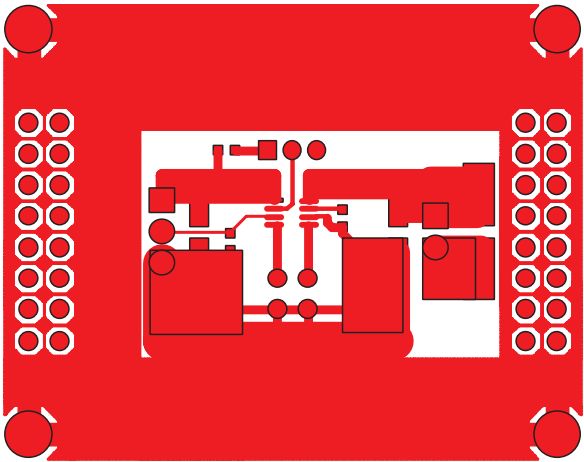
The AAT3258 evaluation layout (Figures 3, 4, and 5) follows the recommend printed circuit board layout procedures and can be used as an example for good application layouts.

Note: Board layout shown is not to scale.

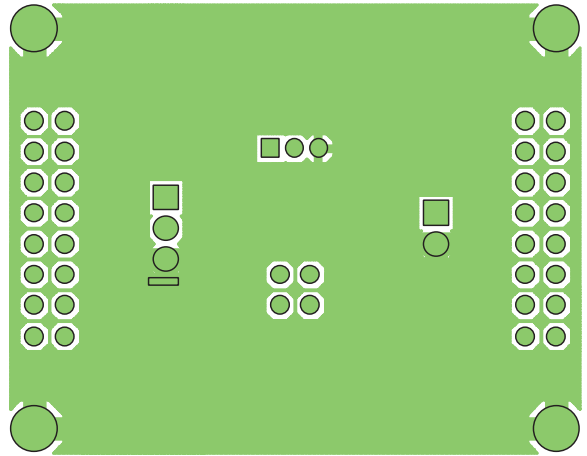


**Figure 2: Typical Behavior of Short Duration Pulses vs. RESET Comparator Overdrive.**

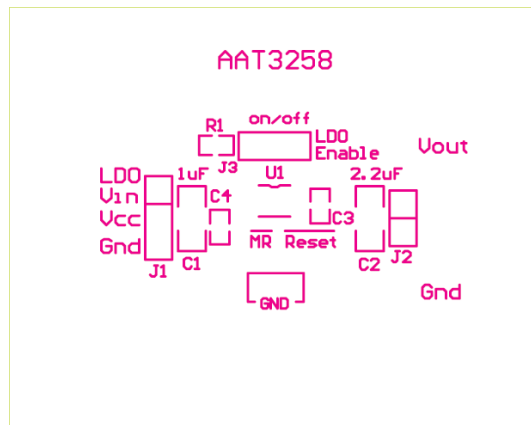
*300mA LDO Linear Regulator with  $\mu$ P Reset*



**Figure 3: Evaluation Board Component Side Layout.**



**Figure 4: Evaluation Board Solder Side Layout.**



**Figure 5: Evaluation Board Top Side Silk Screen Layout / Assembly Drawing.**

# AAT3258

## 300mA LDO Linear Regulator with $\mu P$ Reset

### Ordering Information

Package	Reset Threshold Voltage <sup>1</sup>	LDO Regulator	Marking <sup>2</sup>	Part Number (Tape and Reel) <sup>3</sup>
TSOPJW-8	2.63V	2.80V	IIXYY	<b>AAT3258ITS-2.8-R-T1</b>
TSOPJW-8	2.45V	2.80V	IHXYY	<b>AAT3258ITS-2.8-Y-T1</b>
TSOPJW-8	2.63V	3.0V	MEXYY	<b>AAT3258ITS-3.0-R-T1</b>
TSOPJW-8	2.63V	3.3V	MXYY	<b>AAT3258ITS-3.3-R-T1</b>



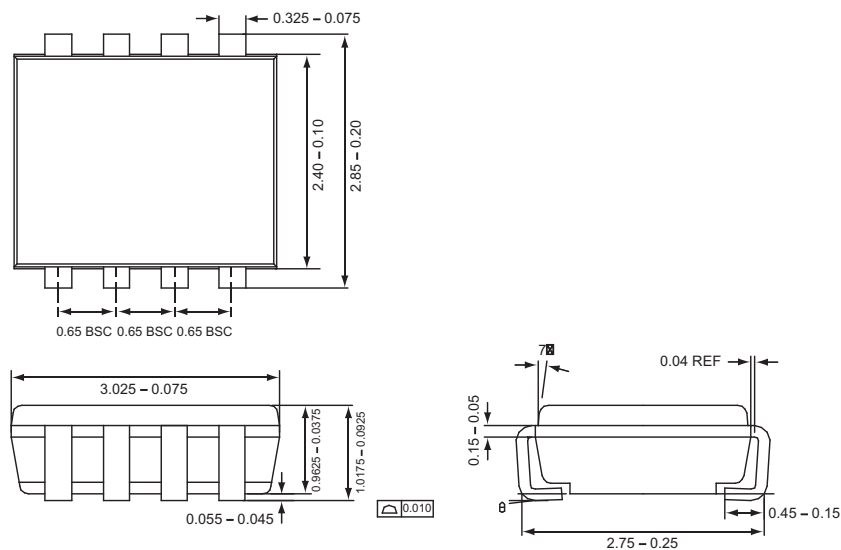
Skyworks Green™ products are compliant with all applicable legislation and are halogen-free.



For additional information, refer to *Skyworks Definition of Green™*, document number SQ04-0074.

### Package Information

#### TSOPJW-8



All dimensions in millimeters.

1. Consult the factory for any additional reset or low dropout voltages.
2. XYY = assembly and date code.
3. Sample stock is generally held on part numbers listed in **BOLD**.

# DATA SHEET

# AAT3258

## 300mA LDO Linear Regulator with $\mu$ P Reset

Copyright © 2012 Skyworks Solutions, Inc. All Rights Reserved.

Information in this document is provided in connection with Skyworks Solutions, Inc. ("Skyworks") products or services. These materials, including the information contained herein, are provided by Skyworks as a service to its customers and may be used for informational purposes only by the customer. Skyworks assumes no responsibility for errors or omissions in these materials or the information contained herein. Skyworks may change its documentation, products, services, specifications or product descriptions at any time, without notice. Skyworks makes no commitment to update the materials or information and shall have no responsibility whatsoever for conflicts, incompatibilities, or other difficulties arising from any future changes.

No license, whether express, implied, by estoppel or otherwise, is granted to any intellectual property rights by this document. Skyworks assumes no liability for any materials, products or information provided hereunder, including the sale, distribution, reproduction or use of Skyworks products, information or materials, except as may be provided in Skyworks Terms and Conditions of Sale.

THE MATERIALS, PRODUCTS AND INFORMATION ARE PROVIDED "AS IS" WITHOUT WARRANTY OF ANY KIND, WHETHER EXPRESS, IMPLIED, STATUTORY, OR OTHERWISE, INCLUDING FITNESS FOR A PARTICULAR PURPOSE OR USE, MERCHANTABILITY, PERFORMANCE, QUALITY OR NON-INFRINGEMENT OF ANY INTELLECTUAL PROPERTY RIGHT; ALL SUCH WARRANTIES ARE HEREBY EXPRESSLY DISCLAIMED. SKYWORKS DOES NOT WARRANT THE ACCURACY OR COMPLETENESS OF THE INFORMATION, TEXT, GRAPHICS OR OTHER ITEMS CONTAINED WITHIN THESE MATERIALS. SKYWORKS SHALL NOT BE LIABLE FOR ANY DAMAGES, INCLUDING BUT NOT LIMITED TO ANY SPECIAL, INDIRECT, INCIDENTAL, STATUTORY, OR CONSEQUENTIAL DAMAGES, INCLUDING WITHOUT LIMITATION, LOST REVENUES OR LOST PROFITS THAT MAY RESULT FROM THE USE OF THE MATERIALS OR INFORMATION, WHETHER OR NOT THE RECIPIENT OF MATERIALS HAS BEEN ADVISED OF THE POSSIBILITY OF SUCH DAMAGE.

Skyworks products are not intended for use in medical, lifesaving or life-sustaining applications, or other equipment in which the failure of the Skyworks products could lead to personal injury, death, physical or environmental damage. Skyworks customers using or selling Skyworks products for use in such applications do so at their own risk and agree to fully indemnify Skyworks for any damages resulting from such improper use or sale.

Customers are responsible for their products and applications using Skyworks products, which may deviate from published specifications as a result of design defects, errors, or operation of products outside of published parameters or design specifications. Customers should include design and operating safeguards to minimize these and other risks. Skyworks assumes no liability for applications assistance, customer product design, or damage to any equipment resulting from the use of Skyworks products outside of stated published specifications or parameters.

Skyworks, the Skyworks symbol, and "Breakthrough Simplicity" are trademarks or registered trademarks of Skyworks Solutions, Inc., in the United States and other countries. Third-party brands and names are for identification purposes only, and are the property of their respective owners. Additional information, including relevant terms and conditions, posted at [www.skyworksinc.com](http://www.skyworksinc.com), are incorporated by reference.