



Chipsmall Limited consists of a professional team with an average of over 10 year of expertise in the distribution of electronic components. Based in Hongkong, we have already established firm and mutual-benefit business relationships with customers from,Europe,America and south Asia,supplying obsolete and hard-to-find components to meet their specific needs.

With the principle of “Quality Parts,Customers Priority,Honest Operation,and Considerate Service”,our business mainly focus on the distribution of electronic components. Line cards we deal with include Microchip,ALPS,ROHM,Xilinx,Pulse,ON,Everlight and Freescale. Main products comprise IC,Modules,Potentiometer,IC Socket,Relay,Connector.Our parts cover such applications as commercial,industrial, and automotives areas.

We are looking forward to setting up business relationship with you and hope to provide you with the best service and solution. Let us make a better world for our industry!



Contact us

Tel: +86-755-8981 8866 Fax: +86-755-8427 6832

Email & Skype: info@chipsmall.com Web: www.chipsmall.com

Address: A1208, Overseas Decoration Building, #122 Zhenhua RD., Futian, Shenzhen, China



DATA SHEET

AAT3693: 1.6 A Li-Ion/Polymer Battery Charger

Applications

- Bluetooth® headsets
- Cell phones
- Digital still cameras
- MP3 players
- Personal data assistants (PDAs)
- Other Li-Ion battery powered devices

Features

- USB or AC adapter system power charger
- Programmable from 100 mA to 1.6 A max.
- Input voltage range: 4.0 V ~ 7.5 V
- High level of integration with internal:
 - Charging device
 - Reverse blocking diode
 - Current sensing
- Digitized thermal regulation
- Charge current programming (ISET)
- Charge termination current programming (TERM)
- Charge timer (CT)
- Battery temperature sensing (TS)
- No-battery detection
- TS pin open detection
- Automatic recharge sequencing
- Full battery charge auto turn off/sleep mode/charge termination
- Shutdown current < 6 μ A
- Automatic trickle charge for battery preconditioning
- Over-voltage and over-current protection
- Emergency thermal protection
- Power-on reset and soft start
- 2.2 x 2.2 TDFN Package
- TDFN (10-pin, 2.2 mm \times 2.2 mm) package (MSL1, 260 $^{\circ}$ C per JEDEC J-STD-020)

Description

The AAT3693 BatteryManager is a highly integrated single-cell lithium-ion/polymer (Li-Ion) battery charger that operates from a USB port or an AC adapter input with up to 7.5 V input voltage. The AAT3693 precisely regulates battery charge voltage and current for 4.2 V Li-Ion battery cells. The battery charging current can be set by an external resistor up to 1.6 A. Digital Thermal Loop Control maintains the maximum possible battery charging current for the given set of input to output power dissipation and ambient temperature conditions.

Battery charge state is continuously monitored for fault conditions. In the event of an over-current, over-voltage, short-circuit, or over-temperature condition, the device shuts down automatically to protect the charging device, the control system, and the battery under-charge. A status monitor output pin is provided to indicate the battery charge status by directly driving an external LED. An open-drain power source detection output is provided to report the power supply status. With the "No-Battery Detection" circuit integrated, the status LEDs indicate that the battery is not present or not properly installed.

The AAT3693 is available in the Pb-free, thermally enhanced, space-saving 10-pin, 2.2 mm \times 2.2 mm TDFN packages and is specified for operation over the -40° C to $+85^{\circ}$ C temperature range.

A typical application circuit is shown in Figure 1. The pin configurations are shown in Figure 2. Signal pin assignments and functional pin descriptions are provided in Table 1.



Skyworks Green™ products are compliant with all applicable legislation and are halogen-free. For additional information, refer to *Skyworks Definition of Green™*, document number SQ04-0074.

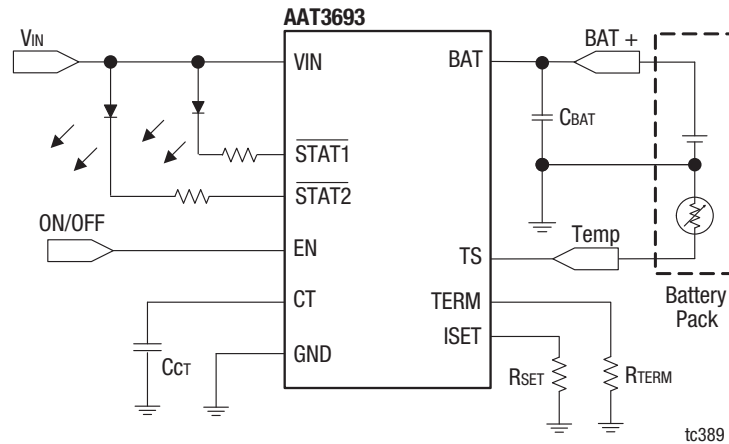

Figure 1. AAT3693 Typical Application Circuit

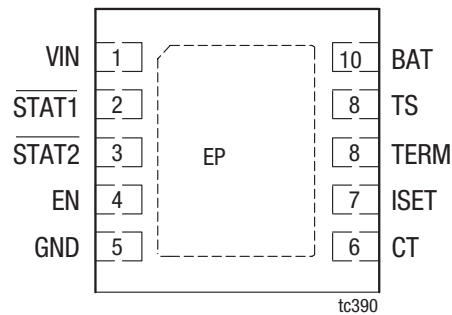

Figure 2. AAT3693 Pinout (Top View)

Table 1. AAT3693 Signal Descriptions

Pin	Name	Type	Description
1	VIN	I	Input from USB port/adaptor connector.
2	STAT1	O	Charge status pin, open-drain.
3	STAT2	O	Charge status pin, open-drain.
4	EN	I	Active high enable pin (with internal pull-down).
5	GND	I/O	Connect to power ground.
6	CT	I	Charge timer programming input pin.
7	ISET	I	Charge current programming input pin.
8	TERM	I	Charge termination current programming input pin (internal default 10% termination current if TERM is open).
9	TS	I/O	Battery temperature sense pin.
10	BAT	O	Connect to lithium-ion battery.
EP	EP		Exposed paddle (bottom): connect to ground as closely as possible to the device.

Electrical and Mechanical Specifications

The absolute maximum ratings of the AAT3693 are provided in Table 2, the thermal information is listed in Table 3, and electrical specifications are provided in Table 4.

Typical performance characteristics of the AAT3693 are illustrated in Figures 3 through 24.

Table 2. AAT3693 Absolute Maximum Ratings¹

Parameter	Symbol	Minimum	Typical	Maximum	Units
IN continuous	VIN	-0.3		8.0	V
BAT, STAT1, STAT2, EN, ISET, TS	VBAT, VSTAT1, VSTAT2, VEN, VISET, VTS	-0.3		VIN + 0.3	V
Junction temperature range	TJ	-40		+150	°C
Operating temperature range	TOP	-40		+85	°C
Maximum soldering temperature (at leads)	TLEAD			300	°C

¹ Exposure to maximum rating conditions for extended periods may reduce device reliability. There is no damage to device with only one parameter set at the limit and all other parameters set at or below their nominal value. Exceeding any of the limits listed may result in permanent damage to the device.

Table 3. AAT3693 Thermal Information

Parameter	Symbol	Value	Units
Maximum thermal resistance ¹	θJA	50	°C/W
Maximum power dissipation ²	PD	2	W

¹ Mounted on an FR4 board.

² At 25 °C ambient temperature.

ESD HANDLING: *Although this device is designed to be as robust as possible, electrostatic discharge (ESD) can damage this device. This device must be protected at all times from ESD when handling or transporting. Static charges may easily produce potentials of several kilovolts on the human body or equipment, which can discharge without detection. Industry-standard ESD handling precautions should be used at all times.*

Table 4. AAT3693 Electrical Specifications¹ (1 of 2)
(VIN = 5.5 V, TA = -40 °C to +85°C, RSET = 1.47 kΩ, RTERM = OPEN. Unless Otherwise Noted, Typical Values are TA = 25 °C)

Parameter	Symbol	Test Condition	Min	Typical	Max	Units
Operation						
Input voltage range	VIN		4.0		7.5	V
Under-voltage lockout threshold	VUVLO	Rising edge	3		4	V
UVLO hysteresis				150		mV
Operating current	IOP	Charge current = 100 mA		0.3	1	mA
Sleep mode current	ISLEEP	VBAT = 4.25 V or EN = GND		0.4	1	μA
Leakage current from BAT pin	ILEAKAGE	VBAT = 4 V, VIN pin open		0.4	2	μA
Current Regulation						
Charge current programmable range	ICC(RANGE)		100		1600	mA
Constant-current mode charge current	ΔICC/ICC	VBAT = 3.6 V	-10		+10	%
ISET pin voltage	VISET			2		V
Charge current set factor: ICH_CC/ISET	KI_SET	Constant current mode, VBAT = 3.6 V		800		
TERM pin voltage	VTERM	RTERM = 13.3 kΩ		2		V
Trickle charge current	ICH_TRK/ICC		5	10	15	%ICH_CC
Charge termination threshold current	ICH_TERM/ICC	TERM pin open	5	10	15	% ICH_CC
		RTERM = 13.3 kΩ, ICC ≥ 800 mA	8	10	12	%
Voltage Regulation						
Constant output voltage	VCO(REG)		4.158	4.20	4.242	V
Constant output voltage tolerance	ΔVCO/VCO			0.5		%
Preconditioning voltage threshold	VMIN	(Option available for no trickle charge)	2.5	2.6	2.9	V
Battery recharge voltage threshold	VRCH			VBAT_REG - 0.1		V
Charging Devices						
Charging transistor on-resistance	RDS(ON)	VIN = 4.6 V, VBAT = 4.0 V, Charge current = 1 A			0.6	Ω
Logic Control/Protection						
Input high threshold	VEN(H)		1.6			V
Input low threshold	VEN(L)				0.4	V
STAT pin output voltage	VSTAT	STAT pin sinks 4 mA			0.4	V
STAT pin current sink capability	ISTAT				8	mA
Over-voltage protection threshold	VOVP			4.4		V
Over-current protection threshold	IOCP	(In constant voltage mode)		105		%ICH_CC
TS voltage range for no battery indication	TNOBAT		VIN - 50 mV			V

Table 4. AAT3693 Electrical Specifications¹ (2 of 2)

(VIN = 5.5 V, TA = -40 °C to +85°C, RSET = 1.47 kΩ, RTERM = OPEN. Unless Otherwise Noted, Typical Values are TA = 25 °C)

Parameter	Symbol	Test Condition	Min	Typ	Max	Units
Option for AA, AC, AI, AK²						
Trickle time out	tk	CCT = 0.1 μF, VIN = 5 V		25		minutes
CC + CV mode time out	tc + tv	CCT = 0.1 μF, VIN = 5 V		3		hours
Option for AB, AD, AJ, AK²						
No trickle charge	tk			0		minutes
CC + CV mode time out	tc + tv	CCT = 0.1 μF, VIN = 5 V		3		hours
Option for AE, AG²						
Trickle time out	tk	CCT = 0.1 μF, VIN = 5 V		25		minutes
CC mode time out	tc	CCT = 0.1 μF, VIN = 5 V		1		hours
CV mode time out	tv	CCT = 0.1 μF, VIN = 5 V		2		hours
Option for AF, AH²						
No trickle charge	tk			0		minutes
CC mode time out	tc	CCT = 0.1 μF, VIN = 5 V		1		hours
CV mode time out	tv	CCT = 0.1 μF, VIN = 5 V		2		hours
Option for AC, AD, AG, AH, AK, AL, BO, BP²						
Current source from TS pin	I _{TS}			75		μA
High temperature threshold	V _{TS1}	Threshold		331		mV
		Hysteresis		25		mV
Low temperature threshold	V _{TS2}	Threshold		2.39		V
		Hysteresis		25		mV
Option for AA, AB, AE, AF, AI, AJ, BM, BN²						
High temperature threshold	V _{TS1}		29.1	30	30.9	%VIN
Low temperature threshold	V _{TS2}		58.2	60	61.8	%VIN
Thermal loop entering threshold	T _{LOOP_IN}			115		°C
Thermal loop exiting threshold	T _{LOOP_OUT}			85		°C
Thermal loop regulation	T _{REG}			100		°C
Chip thermal shutdown temperature	T _{SHDN}	Threshold		140		°C

¹ Performance is guaranteed only under the conditions listed in this table.

² Only options AA, AB, AI and AJ have been released.

Typical Performance Characteristics

(VIN = 5.5 V, TA = -40 °C to +85 °C, RSET = 1.47 kΩ, RTERM = OPEN. Unless Otherwise Noted, Typical Values are TA = 25 °C)

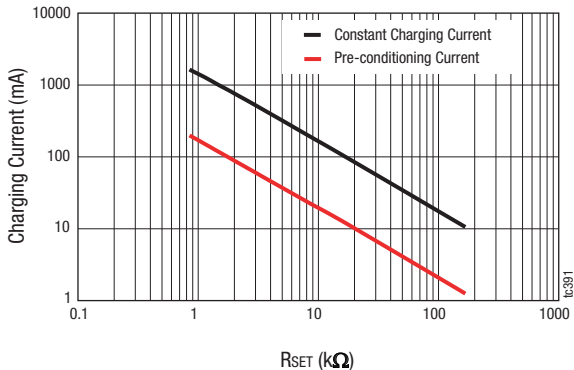

Figure 3. Charging Current vs RSET Values

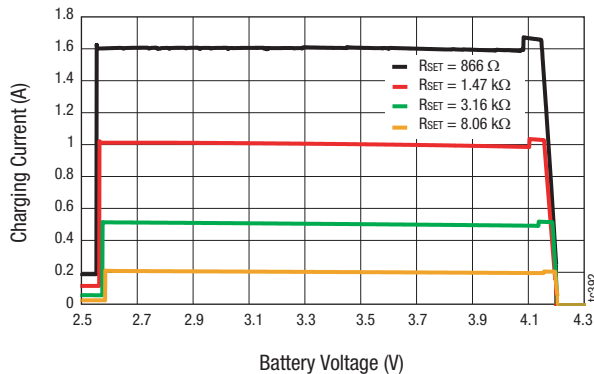

Figure 4. Charging Current vs Battery Voltage

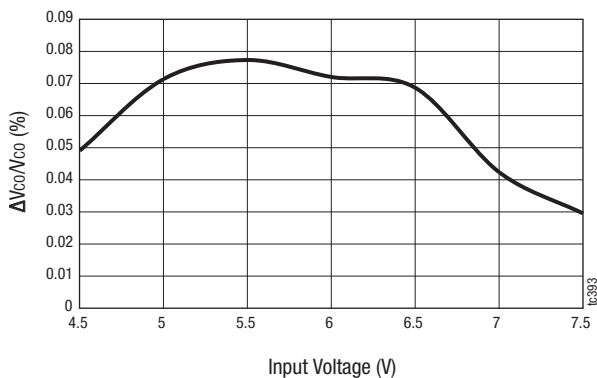

Figure 5. Battery Charger Constant Output Voltage Accuracy vs Input Voltage (Battery Voltage = 4.2 V)

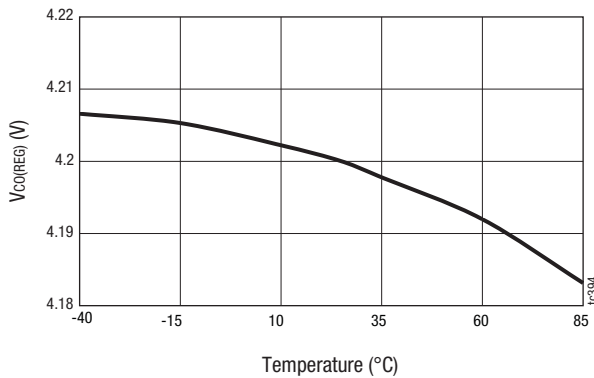

Figure 6. Battery Charger Constant Output Voltage vs Temperature

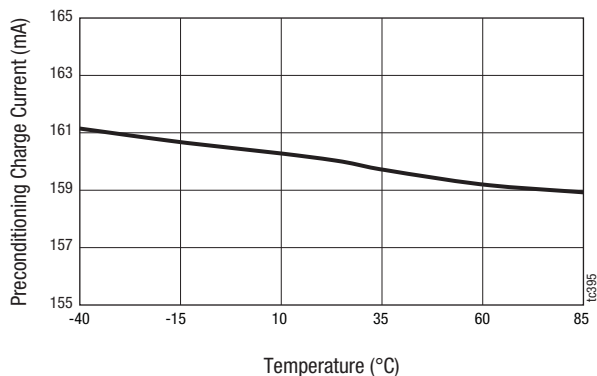

Figure 7. Preconditioning Charge Current vs Temperature (RSET = 866 Ω)

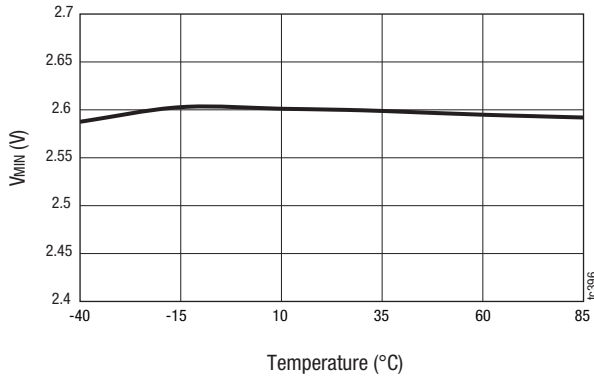

Figure 8. Preconditioning Voltage Threshold vs Temperature

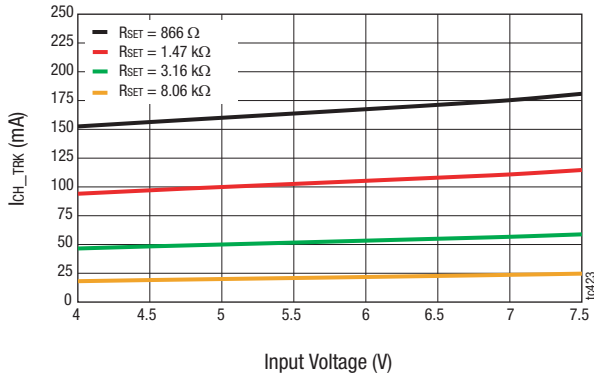

Figure 9. Preconditioning Charge Current vs Input Voltage

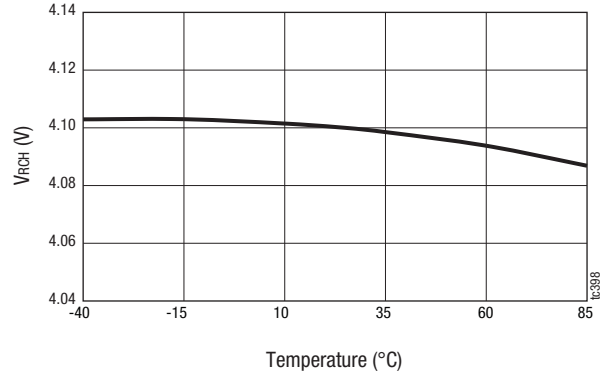

Figure 10. Battery Recharge Voltage Threshold vs Temperature

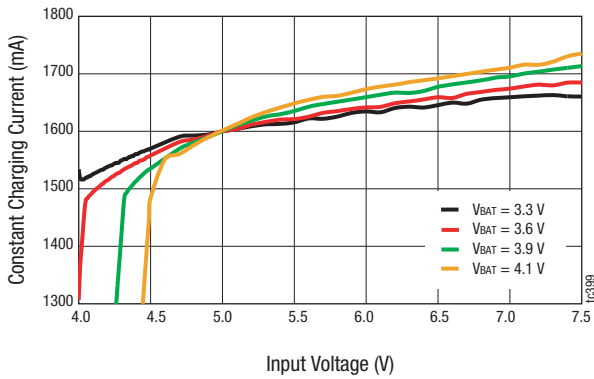

Figure 11. Constant Charging Current vs Input Voltage (RSET = 866 Ω)

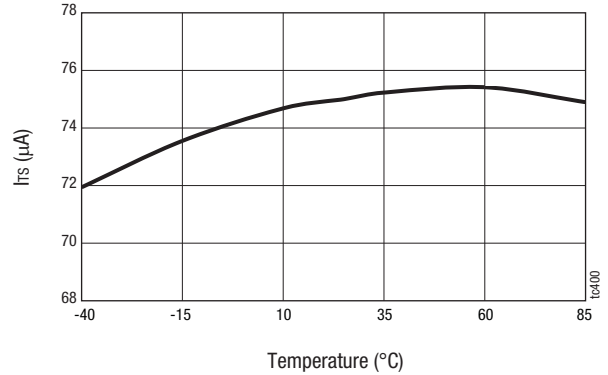

Figure 12. Current Source at the TS Pin vs Temperature (for Option AC, AD, AG, AH, AK, AL, BO, BP)

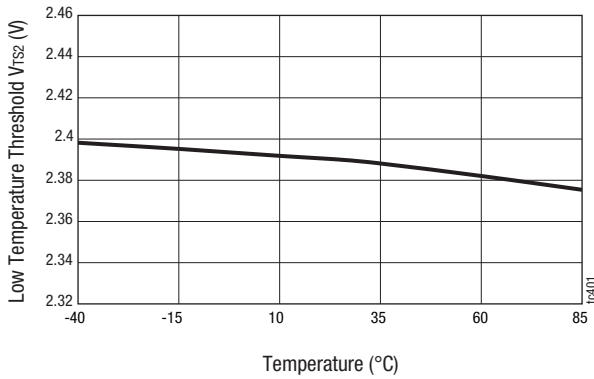

Figure 13. Low Temperature Threshold vs Temperature (for Option AC, AD, AG, AH, AK, AL, BO, BP)

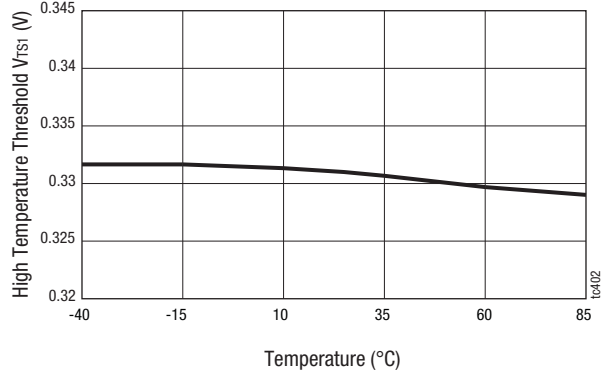

Figure 14. High Temperature Threshold vs Temperature (for Option AC, AD, AG, AH, AK, AL, BO, BP)

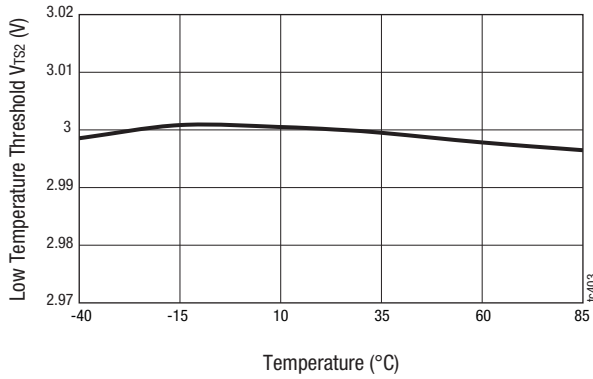

Figure 15. Low Temperature Threshold vs Temperature (for Option AA, AB, AE, AF, AI, AJ, BM, BN; VIN = 5 V)

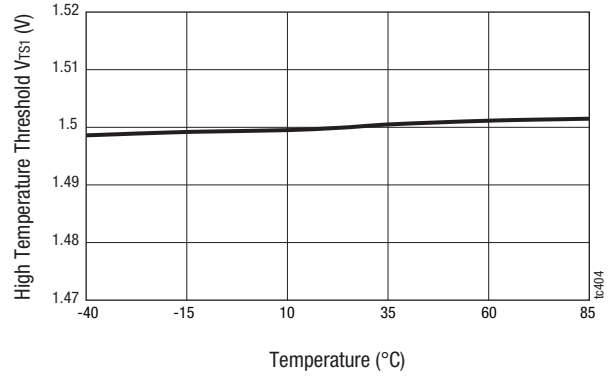

Figure 16. High Temperature Threshold vs Temperature (for Option AA, AB, AE, AF, AI, AJ, BM, BN; VIN = 5 V)

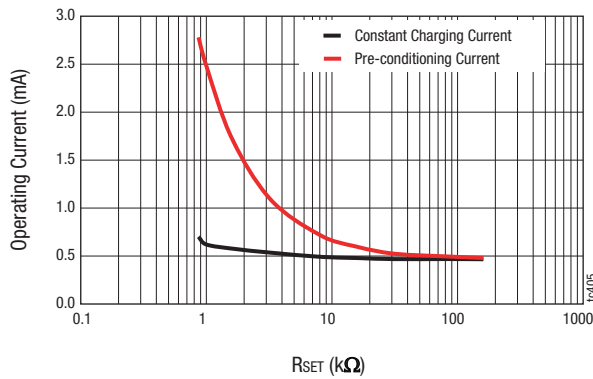

Figure 17. Operating Current vs ISET Resistor

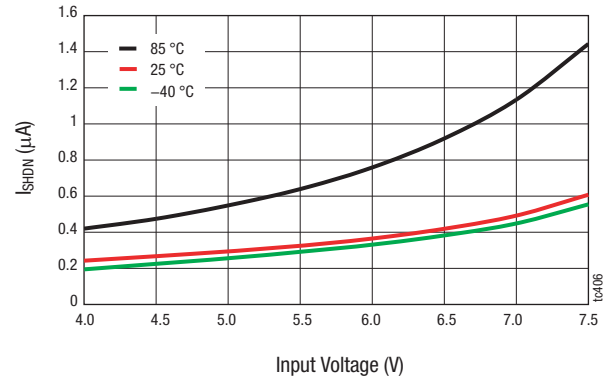

Figure 18. Shutdown Current vs Input Voltage

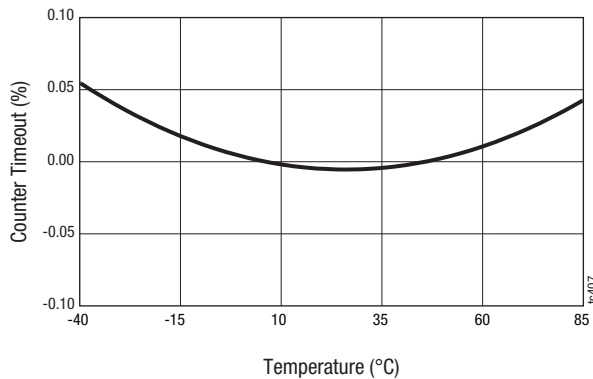

Figure 19. Counter Timeout vs Temperature (Ccr = 0.1 μF)

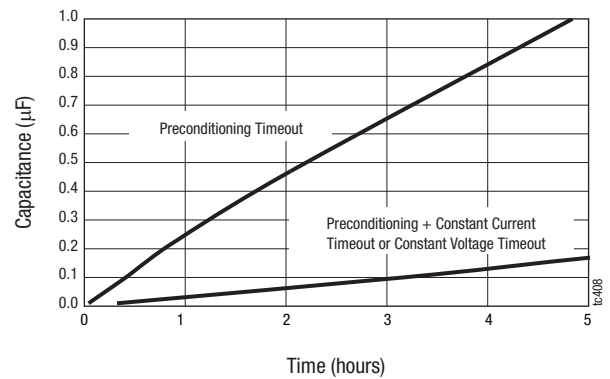

Figure 20. CT Pin Capacitance vs Counter Timeout

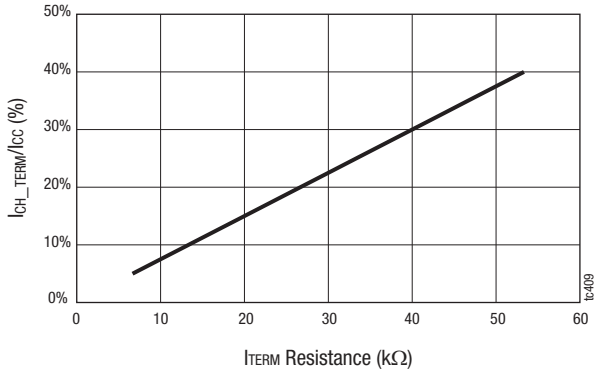

Figure 21. Termination Current to Constant Current Ratio (%) vs Termination Resistance

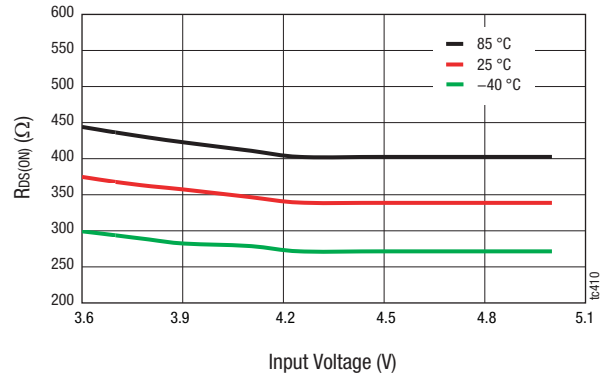

Figure 22. Charging Transistor On Resistance vs Input Voltage

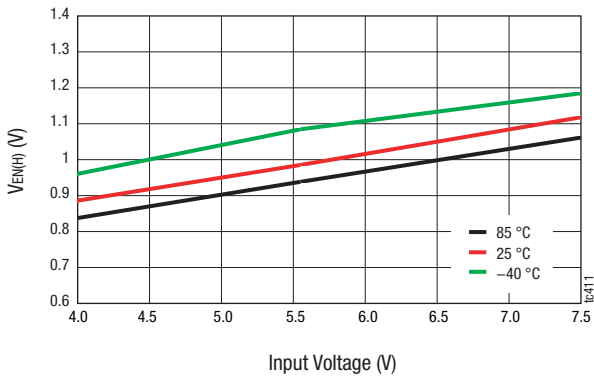

Figure 23. Input High Threshold vs Input Voltage

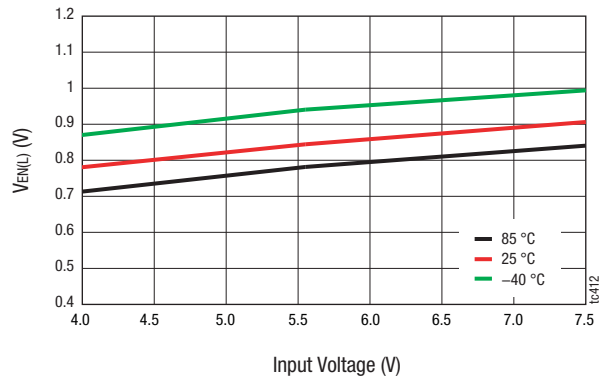

Figure 24. Input High Threshold vs Input Voltage

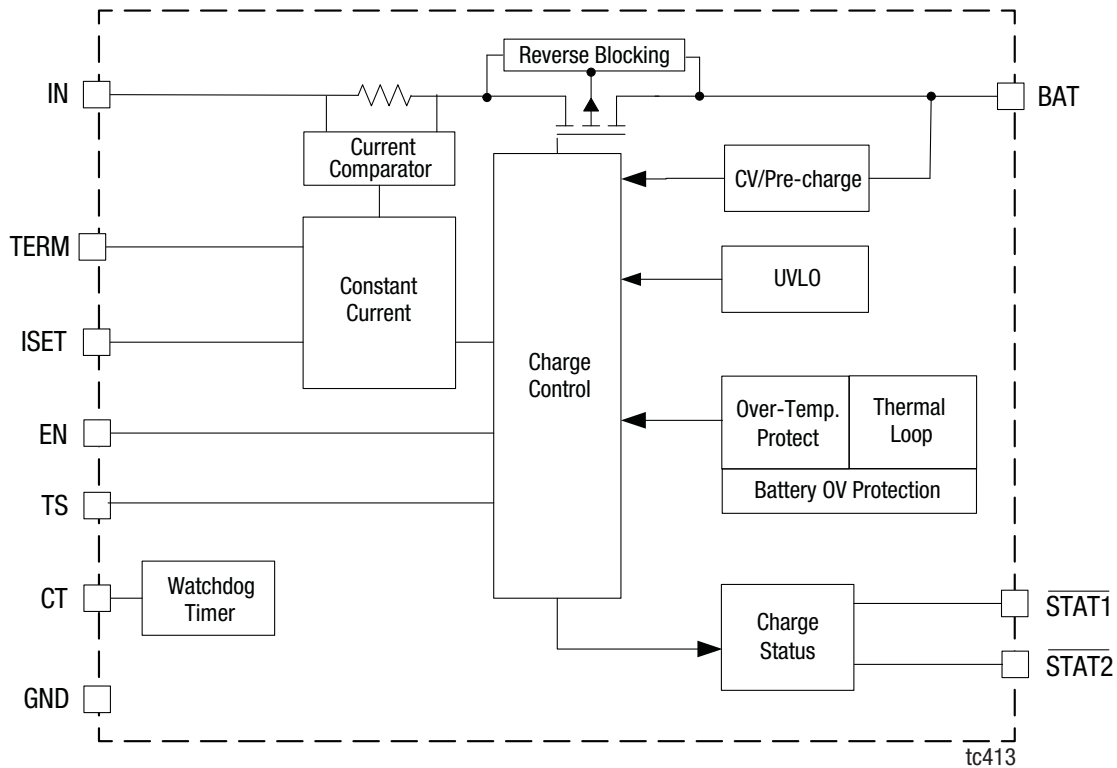

Figure 25. AAT3693 Functional Block Diagram

Functional Description

A functional block diagram is shown in Figure 25.

The AAT3693 is a high-performance battery charger designed to charge single-cell lithium-ion or lithium-polymer batteries with up to 1.6 A of current from an external power source. It is a standalone charging solution, with just one external component required for complete functionality.

The AAT3693 precisely regulates battery charge voltage and current for 4.2 V lithium-ion/polymer battery cells with constant current level being programmed up to 1.6 A for rapid charging applications. The charge termination current can be programmed by an external resistor.

The AAT3693 is rated for operation from $-40\text{ }^{\circ}\text{C}$ to $+85\text{ }^{\circ}\text{C}$. In the event of operating ambient temperatures exceeding the power dissipation abilities of the device package for a given constant current charge level, the charge control enters into thermal limit.

The AAT3693 provides two status monitor output pins ($\overline{\text{STAT1}}$ and $\overline{\text{STAT2}}$) which directly drive two external LEDs to indicate the battery charging state. With no-battery detection and status indication, the user can be notified if the battery is not inserted properly.

Device junction temperature and charge state are fully monitored for fault conditions. In the event of an over-voltage or over-temperature failure, the device automatically shuts down to protect the charging device, control system and the battery under-charge.

During battery charging, the device temperature rises. In some cases with adapter charging, the power dissipation in the device may cause the junction temperature to rise closer to its thermal shutdown threshold.

In the event of an internal over-temperature condition caused by excessive ambient operating temperature or excessive power dissipation condition, the AAT3693 enables a digitally controlled thermal loop system to reduce the charging current to prevent the device from thermal shutdown. The digital thermal loop maintains the maximum possible battery charging current for the given set of input to output power dissipation and ambient temperature conditions.

The digital thermal loop control is dynamic in the sense that it continues to adjust the battery charging current as operating conditions change.

The digital thermal loop resets and resumes normal operation when the power dissipation or over-temperature conditions are removed.

Charging Operation

Figure 26 illustrates the entire battery charging profile or operation, which consists of four phases:

1. Preconditioning (Trickle) Charge
2. Constant Current Charge
3. Constant Voltage Charge
4. Automatic Recharge

Battery Preconditioning

Battery charging commences only after the AAT3693 checks several conditions in order to maintain a safe charging environment. The input supply must be above the minimum operating voltage (V_{UVLO}) and the enable pin must be high.

When the battery is connected to the BAT pin, the AAT3693 checks the condition of the battery and determines which charging mode to apply. If the battery voltage is below the preconditioning voltage threshold, V_{MIN} , the AAT3693 begins preconditioning the battery cell (trickle charging) by charging at 10% of the programmed constant current. For example, if the programmed current is 500 mA, the preconditioning mode

(trickle charge) current is 50 mA. Battery cell preconditioning (trickle charging) is a safety precaution for deeply discharged cells and also reduces the power dissipation in the internal series pass MOSFET when the input-output voltage differential is at the greatest potential.

Constant Current Charging

Battery cell preconditioning continues until the battery voltage reaches the preconditioning voltage threshold, V_{MIN} . At this point, the AAT3693 begins constant current charging. The current level for this mode is programmed using a single resistor from the ISET pin to ground. Programmed current can be set from a minimum of 100 mA up to a maximum of 1.6 A

Constant Voltage Charging

Constant current charging continues until the battery voltage reaches the constant output voltage (end of charge) voltage regulation point, $V_{CO(REG)}$. When the battery voltage reaches $V_{CO(REG)}$, the AAT3693 will transition to constant voltage mode. The regulation voltage is factory programmed to a nominal 4.2 V and continues charging until the charge termination current is reached.

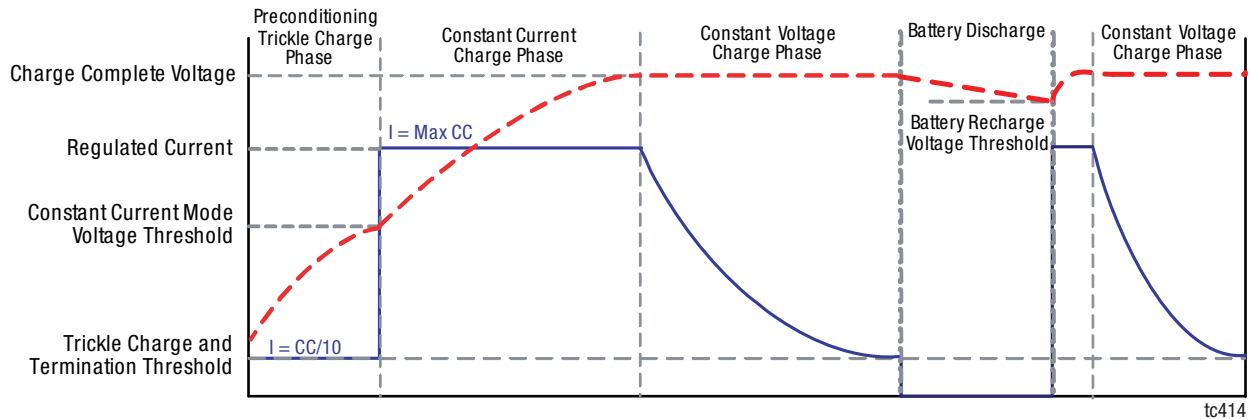

Figure 26 . Current vs Voltage Profile during Charging Phases

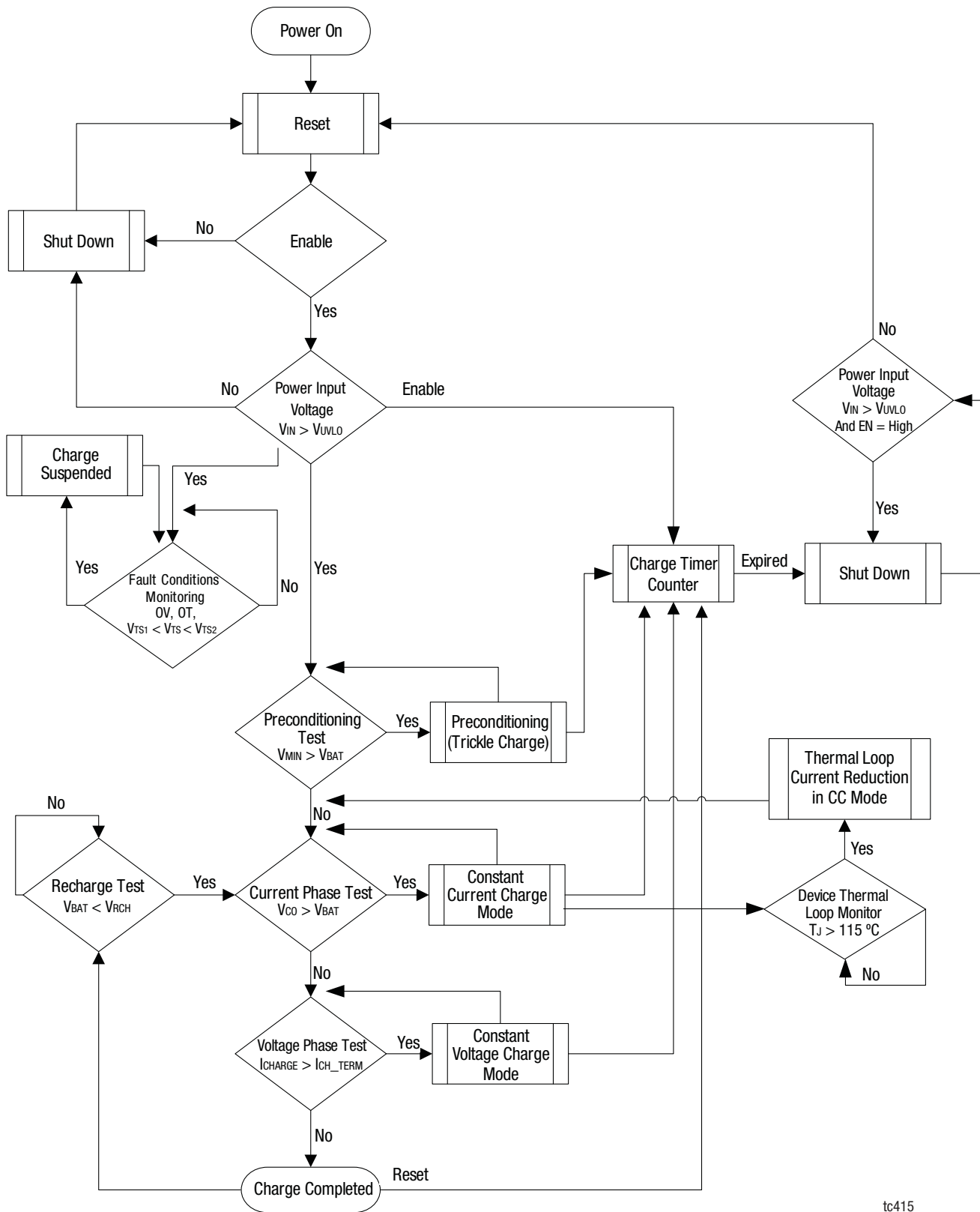

Figure 27. System Operation Flowchart for the Battery Charger

tc415

Application Information

Adapter or USB Power Input

Constant current charge levels up to 1.6 A can be programmed by the user when powered from a sufficient input power source. The AAT3693 operates from the adapter input over a 4.0 V to 7.5 V range. The constant current mode fast charge current for the adapter input is set by the RSET resistor connected between ISET and ground. Refer to Table 5 for recommended RSET values for a desired constant current charge level; values are rounded off to 1% standard resistance values.

Automatic Recharge

The AAT3693 has a UVLO and power-on reset feature so that if the input supply to the VIN pin drops below the UVLO threshold, the charger suspends charging and shuts down. When power is reapplied to the IN pin or the UVLO condition recovers, the system charge control assesses the state of charge on the battery cell and automatically resumes charging in the appropriate mode for the condition of the battery.

Enable / Disable

The AAT3693 provides an enable function to control the charger IC on and off. The enable (EN) pin is internally pulled down. When pulled to a logic high level, the AAT3693 is enabled. When left open or pulled to a logic low level, the AAT3693 is shut down. Charging is halted regardless of the battery voltage or charging state. When the device is re-enabled, the charge control circuit automatically resets and resumes charging functions with the appropriate charging mode based on the battery charge state and measured cell voltage on the BAT pin.

Programming Charge Current

The constant current mode charge level is user programmed with a set resistor placed between the ISET pin and ground. The accuracy of the constant charge current, as well as the preconditioning trickle charge current, is dominated by the tolerance of the set resistor used. For this reason, a 1% tolerance metal film resistor is recommended for the set resistor function. The constant charge current levels from 100 mA to 1.6 A can be set by selecting the appropriate resistor value from Table 5. The relationship between the charging current and the RSET values is shown in Figure 3.

Table 5. Constant Charging Current vs RSET

Constant Charging Current (mA)	RSET (k Ω)
100	16.5
200	8.06
300	5.36
400	4.02
500	3.16
600	2.67
700	2.26
800	1.87
900	1.78
1000	1.47
1250	1.18
1600	0.866

Programmable Charge Termination Current

The AAT3693 provides a user-programmable charge termination current at the end of the charge cycle. When the battery cell voltage sensed by the BAT pin reaches 4.2 V, the charge control transitions from constant current fast charge mode to constant voltage mode. In constant voltage mode, the battery cell voltage is regulated at 4.2 V. The charge current drops as the battery reaches its full charge capacity. When the charge current drops to the programmed end of charge $V_{CO(REG)}$ current, the charge cycle is complete and the charge controller terminates the charging process.

If the TERM pin is left open, the termination current sets to 10% of the constant charging current as the default value.

The charge termination current I_{CH_TERM} can be programmed by connecting a resistor from TERM to GND. Use the values listed in Table 6 to set the desired charge termination current. The relationship between the charging termination threshold current and the RSET values is shown as Figure 21.

Table 6. Charge Termination Threshold Current Programming Resistor Values

RTERM (k Ω)	I_{CH_TERM}/I_{CC} (%)
6.65	5%
13.3	10%
26.7	20%
40.2	30%
53.6	40%

Table 7. LED Status Indicator (STATx Pulled Up to a Voltage Source with Resistors and LED) (Note 1)

Event Description	All Options	Options AA, AB, AE, AF, AI, AJ, BM and BN	Options AC, AD, AG, AH, AK, AL, BO and BP
	STAT1	STAT2 Type 1	STAT2 Type 2
No battery (with charge enabled)	Flash	Flash	Flash
Battery charging	Low	High	High
Charge complete	High	Low	High
Fault condition	High	High	Low

Note 1: Low = LED ON; High = LED OFF.

If the desired end of charge termination current level is not listed in Table 6, the TERM resistor value can be calculated by the following equation:

$$I_{CH_TERM} = \frac{15 \mu A \times R_{TERM}}{2V} \times I_{CC}$$

When the charge current drops to the programmed charge termination current level in the constant voltage mode, the device terminates charging and goes into a sleep state. The charger remains in this sleep state until the battery voltage decreases to a level below the battery recharge voltage threshold (VRCH).

In such cases where the AAT3693 input voltage drops, the device enters the sleep state and automatically resumes charging once the input supply has recovered from the fault condition. Consuming very low current in the sleep state, the AAT3693 minimizes battery drain when it is not charging. This feature is particularly useful in applications where the input supply level can fall below the battery charge or under-voltage lockout level.

Charge Status Outputs

The AAT3693 provides battery charge status via two status pins. These pins are internally connected to an N-channel open-drain MOSFET, which can be used drive external LEDs. The status pins can indicate the conditions shown in Table 7.

The AAT3693 has a battery fault detector, which, when used in conjunction with a 0.1 μF capacitor on the CT pin, outputs a 1Hz signal with 50% duty cycle at the STAT1 pin in the event of a timeout while in the trickle charge mode.

Fault conditions can be one of the following:

- Battery over voltage (OV)
- Battery temperature sense hot or cold
- Battery charge timer time-out
- Chip thermal shutdown

Status LED Setup

The LEDs should be biased with as little current as necessary to create reasonable illumination; therefore, a ballast resistor should be placed between the LED cathode and the STAT pin (2 mA should be sufficient to drive most low-cost green or red LEDs). It is not recommended to exceed 8 mA for driving an individual status LED. The required ballast resistor values can be estimated using the following formula:

$$R_{BALLSAT} = \frac{V_{IN} - V_{F(LED)}}{I_{LED}}$$

Example:

$$R_{BALLSAT} = \frac{5.0V - 2.0V}{2mA} = 1.5k\Omega$$

Note: Red LED forward voltage (VF) is typically 2.0 V @ 2 mA.

Protection Circuitry

No-Battery Detection

After a battery is inserted and the AAT3693 detects the battery, the regular LED reporting indicates the current charging status after 5 or 6 flashes. If the battery is not detected, the status LEDs flash at a frequency of 1 Hz with ~50% duty cycle ratio continuously on all options (AAT3693 AA, AB, ... , BO and BT), except AI and AJ.

The no-battery detection circuit is not integrated in the AAT3693 AI or AJ. For these two options, the charger IC treats the output ceramic capacitor as a battery. Since the capacitance of the ceramic capacitor is very small, the charge cycle is shortened and the STAT1 LED stays OFF for a long time and ON for a very short time. Therefore, the STAT1 LED appears to always be OFF. In addition, since the ceramic capacitor's discharge cycle is much longer than its charge cycle, the STAT2 LED appears to remain ON because the brief OFF phase of the cycle is so short that the human eye cannot perceive it.

If the thermal sensing TS pin is open, it would be considered as no battery condition. Please refer to the *Battery Temperature Fault Monitoring* section to determine the proper biasing for the TS pin.

Programmable Watchdog Timer

The AAT3693 contains a watchdog timing circuit to shut down charging functions in the event of a defective battery cell not accepting a charge over a preset period of time. Typically, a 0.1 μF ceramic capacitor is connected between the CT pin and ground. When a 0.1 μF ceramic capacitor is used, the device times out a shutdown condition if the trickle charge mode exceeds 25 minutes. The time-out timer resets at start of the constant current mode setting the time-out to 1 hour (default). When the device transitions to the constant voltage mode, the timing counter is reset and times out after an additional 2 hours if the charge current does not drop to the charge termination level for options AE, AF, AG, AH, BM, BN, BO and BP. For all other options (AA, AB, AC, AD, AI, AJ, AK and AL), the timeout timer does not reset at every charging mode and times out in 3 hours (default). Table 8 list the time-out options.

Table 8. Watchdog Timer Time-Out Options

Mode	Timer	Time	Units
Trickle Charge (TC) timeout	Reset	25	Minute
Constant Current (CC) timeout	Reset	1	Hour
Constant Voltage (CV) timeout	Reset	2	Hour

Assuming: $C_{CT} = 0.1 \mu\text{F}$ and $V_{IN} = 5.0 \text{ V}$.

The CT pin is driven by a constant current source and provides a linear response to increases in the timing capacitor value. Thus, if the timing capacitor were to be doubled from the nominal 0.1 μF value, the time-out periods would be doubled. The CT pin should always have a capacitor connected to ground to avoid errors in the internal timing control. The constant current provided to charge the timing capacitor is very small, and this pin is susceptible to noise and changes in capacitance value. Therefore, the timing capacitor should be physically located on the printed circuit board layout as close as possible to the CT pin. Since the accuracy of the internal timer is dominated by the capacitance value, a 10% tolerance or better ceramic capacitor is recommended. Ceramic capacitor materials, such as X7R and X5R types are a good choice for this application.

Battery Over-Voltage Protection

An over-voltage event is defined as a condition where the voltage on the BAT pin exceeds the maximum battery charge voltage and is set by the overvoltage protection threshold (V_{OV}). If an over-voltage condition occurs, the AAT3693 charge control shuts down the device until the voltage on the BAT pin drops

below V_{OV} . The AAT3693 resumes normal charging operation after the overvoltage condition is removed. During an over-voltage event, the STAT1 LED reports a system fault.

Over-Temperature Shutdown

The AAT3693 has a thermal protection control circuit that shuts down charging functions if the internal die temperature exceeds the preset thermal limit threshold. Once the internal die temperature falls below the thermal limit, normal operation resumes the previous charging state.

Battery Temperature Fault Monitoring

In the event of a battery over-temperature condition, the charge control turns off the internal pass device. The STAT LEDs also display a system fault. After the system recovers from a temperature fault, the device resumes charging operation.

The AAT3693 checks battery temperature before starting the charge cycle, as well as during all phases of charging. This is accomplished by monitoring the voltage at the TS pin. This system is intended for use with negative temperature coefficient thermistors (NTC) that are typically integrated into the battery package. Most of the commonly used NTC thermistors in battery packs are approximately 10 $\text{k}\Omega$ at room temperature (25 $^{\circ}\text{C}$).

For options AC, AD, AG, AH, AK, AL, BO, and BP, the TS pin has been specifically designed to source 75 μA of current to the thermistor. The voltage on the TS pin resulting from the resistive load should stay within a window of 331 mV to 2.39 V. If the battery becomes too hot during charging due to an internal fault or excessive constant charge current, the thermistor heats up and reduces in value, pulling the TS pin voltage lower than the TS1 threshold, and the AAT3693 stops charging until the condition is removed, then charging is resumed. If the use of the TS pin function is not required by the system, it should be terminated to ground using a 10 $\text{k}\Omega$ resistor.

For options AA, AB, AE, AF, AI, AJ, BM, and BN, the internal battery temperature sensing system is comprised of two comparators which establish a voltage window for safe operation. The thresholds for the TS operating window are bounded by the TS1 and TS2 specifications. Referring to Table 4, the TS1 threshold = $0.30 \times V_{IN}$ and the TS2 threshold = $0.60 \times V_{IN}$. If the use of the TS pin function is not required by the system, the TS pin should be connected to input supply V_{IN} .

Figure 28 shows the battery temperature sensing operation.

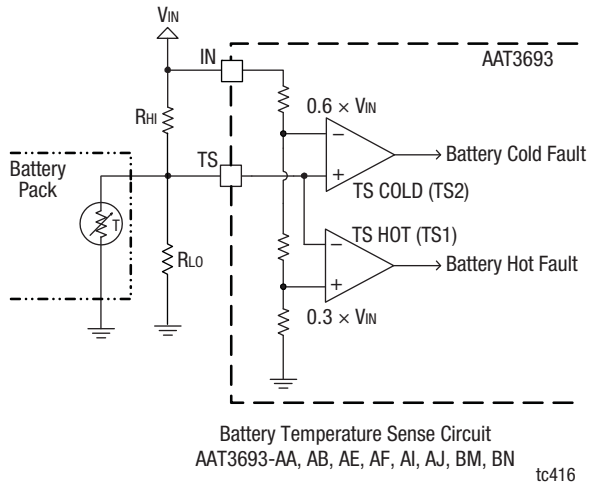

Figure 28. Battery Temperature Sensing Operation

$$R_{LO} = \frac{V_{IN} \times R_{COLD} \times R_{HOT} \times \left(\frac{1}{V_{COLD}} - \frac{1}{V_{HOT}} \right)}{R_{HOT} \times \left(\frac{V_{IN}}{V_{HOT}} - 1 \right) - R_{COLD} \times \left(\frac{V_{IN}}{V_{COLD}} - 1 \right)}$$

$$R_{HI} = \frac{\frac{V_{IN}}{V_{COLD}} - 1}{\frac{1}{R_{LO}} + \frac{1}{R_{COLD}}}$$

Where,

$$V_{HOT} = 0.3 \times V_{IN}$$

$$V_{COLD} = 0.6 \times V_{IN}$$

V_{IN} = input voltage

R_{HOT} = NTC resistance at high temperature

R_{COLD} = NTC resistance at low temperature

Digital Thermal Loop Control

Due to the integrated nature of the linear charging control pass device for the adapter mode, a special thermal loop control system has been employed to maximize charging current under all operation conditions. The thermal management system measures the internal circuit die temperature and reduces the fast charge current when the device exceeds a preset internal temperature control threshold. Once the thermal loop control becomes active, the fast charge current is initially reduced by a factor of 0.44.

The initial thermal loop current can be estimated by the following equation:

$$I_{TLOOP} = I_{CC} \times 0.44$$

The thermal loop control re-evaluates the circuit die temperature every 3 seconds and adjusts the fast charge current backup in small steps to the full fast charge current

level or until an equilibrium current is discovered and maximized for the given ambient temperature condition. The thermal loop controls the system charge level; therefore, the AAT3693 always provides the highest level of constant current in the fast charge mode possible for any given ambient temperature condition

Thermal Considerations

The AAT3693 is offered in the 10-pin, 2.2 mm × 2.2 mm TDFN package, which can provide up to 2 W of power dissipation when properly bonded to a printed circuit board and has a maximum thermal resistance of 50 °C/W. Many considerations should be taken into account when designing the printed circuit board layout, as well as the placement of the charger IC package in proximity to other heat generating devices in a given application design. The ambient temperature around the charger IC also has an effect on the thermal limits of a battery charging application. The maximum limits that can be expected for a given ambient condition can be estimated by the following discussion.

First, the maximum power dissipation for a given situation should be calculated:

$$P_{D(MAX)} = \frac{T_J - T_A}{\theta_{JA}}$$

Where:

$P_{D(MAX)}$ = maximum power dissipation (W)

θ_{JA} = package thermal resistance (°C/W)

T_J = thermal loop entering threshold (°C) (115°C)

T_A = ambient temperature (°C)

Figure 29 shows the relationship between maximum power dissipation and ambient temperature for the AAT3693.

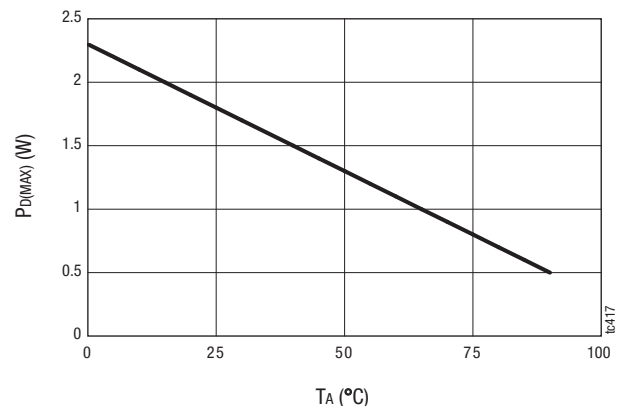

Figure 29. Maximum Power Dissipation before Entering Thermal Loop

Next, the power dissipation can be calculated by the following equation:

$$P_D = (V_{IN} - V_{BAT}) \times I_{CC} + (V_{IN} \times I_{OP})$$

Where:

PD = total power dissipation by the device

VIN = input voltage

VBAT = battery voltage as seen at the bat pin

ICC = constant charge current programmed for the application

IOP = quiescent current consumed by the charger IC for normal operation (0.3 mA)

By substitution, we can derive the maximum charge current before reaching the thermal limit condition (thermal loop). The maximum charge current is the key factor when designing battery charger applications.

$$I_{CH(MAX)} = \frac{P_{D(MAX)} - V_{IN} \times I_{OP}}{V_{IN} - V_{BAT}}$$

$$I_{CH(MAX)} = \frac{\frac{T_{J(MAX)} - T_A}{\theta_{JA}} - V_{IN} \times I_{OP}}{V_{IN} - V_{BAT}}$$

In general, the worst condition is the greatest voltage drop across the charger IC, when battery voltage is charged up to the preconditioning voltage threshold and before entering thermal loop regulation.

Figure 30 shows the maximum charge current at different ambient temperatures.

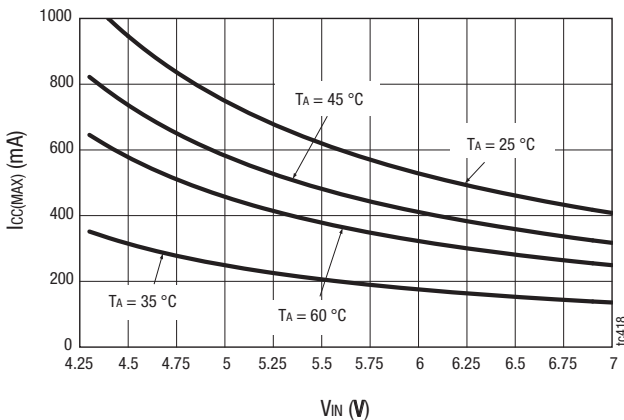

Figure 30. Maximum Charging Current before the Digital Thermal Loop Becomes Active

Capacitor Selection

Input Capacitor

In general, it is good design practice to place a decoupling capacitor closer to the IC and between the IN pin and GND.

An input capacitor in the range of 1 μF to 22 μF is recommended. If the source supply is unregulated, it may be necessary to increase the capacitance to keep the input voltage above the under-voltage lockout threshold during device enable and when battery charging is initiated. If the AAT3693 adapter input is used in a system with an external power supply source, such as a typical AC-to-DC wall adapter, then a CIN capacitor in the range of 10 μF should be used. A larger input capacitor in this application minimizes switching or power transient effects when the power supply is “hot plugged”.

Output Capacitor

The AAT3693 only requires a 1 μF ceramic capacitor on the BAT pin to maintain circuit stability. This value should be increased to 10 μF or more if the battery connection is made any distance from the charger output. If the AAT3693 is to be used in applications where the battery can be removed from the charger, such as with desktop charging cradles, an output capacitor greater than 10 μF may be required to prevent the device from cycling on and off when no battery is present. It is good design practice to place the decoupling capacitor closer to the IC and between the BAT pin and GND.

PCB Layout Considerations

For best results, it is recommended to physically place the battery pack as close as possible to the AAT3693 BAT pin. To minimize voltage drops on the PCB, keep the high current carrying traces adequately wide. When designing with a charging current system >500 mA, a multilayer ground plane PCB design is highly recommended. Putting thermal vias on the thermal pad design effectively transfers heat from the top metal layer of the PCB to the inner or bottom layers. The number of thermal vias depends on the application and power dissipation. The AAT3693 evaluation board (Figure 31) is an example layout for reference.

Evaluation Board Description

The AAT3693 Evaluation Board is used to test the performance of the AAT3693. An Evaluation Board schematic diagram is provided in Figure 31. Layer details for the Evaluation Board are shown in Figure 32. The Evaluation Board has additional components for easy evaluation; the actual bill of materials required for the system is shown in Table 9. Table 10 lists the AAT3693 options.

Package Information

Package dimensions are shown in Figure 33. Tape and reel dimensions are shown in Figure 34.

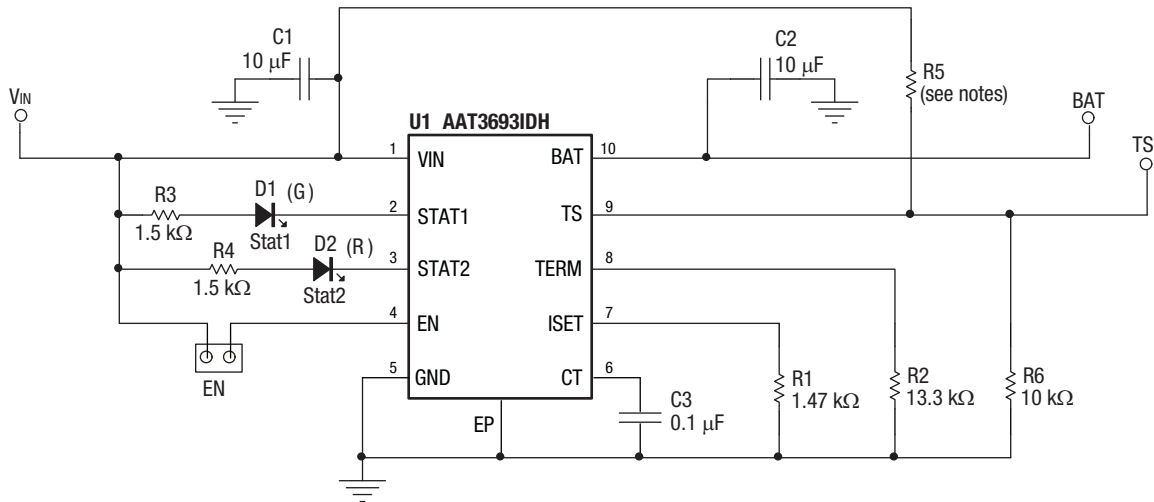

Notes:

R5: 10 kΩ for options AA, AB, AE, AF, AI, AJ, BM, BN
 R5: OPEN for options AC, AD, AG, AH, AK, AL, BO, BP

tc419

Figure 31. AAT3693 Evaluation Board Schematic

Table 9. AAT3693 Evaluation Board Bill of Materials

Component	Part Number	Description	Manufacturer
U1	AAT3693IDH	1.6A linear Li-Ion/polymer battery charger in 2.2 × 2.2 mm TDFN Package	Skyworks
R1	CRCW04021501F	1.47 kΩ, 1%, 1/4 W; 0603	Vishay
R2	CRCW04021332F	13.3 kΩ, 1%, 1/4 W; 0603	Vishay
R5, R6	CRCW04021002F	10 kΩ, 5%, 1/4 W; 0603	Vishay
R3, R4	CRCW04021001F	1.5 kΩ, 5%, 1/4 W; 0603	Vishay
C1, C2	GRM21BR71A106KE51L	CER, 10 µF, 10 V, 10% X7R, 0805	Murata
C3	TMK105BJ104KV	CER, 0.1 µF, 25 V, 10% X5RR, 0402	Taiyo Yuden
EN	PRPN401PAEN	Conn. Header, 2 mm zip	Sullins Electronics
D1	LTST-C190GKT	Green LED, 0603	Lite-On Inc.
D2	LTST-C190CKT	Red LED, 0603	Lite-On Inc.

Table 10. AAT3693 Options

Option Name	Trickle Charge Mode	Temperature Sense		Low Battery Check	Status Reporting		Charge Timer			Constant Output Voltage $V_{CO(REG)}$ (V)
		Low Threshold	High Threshold		STAT1	STAT2	Trickle Charge (TC) Timeout	Constant Current (CC) Charge Timeout	Constant Voltage (CV) Charge Timeout	
AA	Yes	30% of V_{IN}	60% of V_{IN}	Yes	Yes	Type 1	3 hours total			4.2
AB	No	30% of V_{IN}	60% of V_{IN}	Yes	Yes	Type 1	3 hours total			4.2
AC	Yes	0.33 V Fixed	2.39 V Fixed	Yes	Yes	Type 2	3 hours total			4.2
AD	No	0.33 V Fixed	2.39 V Fixed	Yes	Yes	Type 2	3 hours total			4.2
AE	Yes	30% of V_{IN}	60% of V_{IN}	Yes	Yes	Type 1	25 minutes	1 hour	2 hours	4.2
AF	No	30% of V_{IN}	60% of V_{IN}	Yes	Yes	Type 1	25 minutes	1 hour	2 hours	4.2
AG	Yes	0.33 V Fixed	2.39 V Fixed	Yes	Yes	Type 2	25 minutes	1 hour	2 hours	4.2
AH	No	0.33 V Fixed	2.39 V Fixed	Yes	Yes	Type 2	25 minutes	1 hour	2 hours	4.2
AI	Yes	30% of V_{IN}	60% of V_{IN}	No	Yes	Type 1	3 hours total			4.2
AJ	No	30% of V_{IN}	60% of V_{IN}	No	Yes	Type 1	3 hours total			4.2
AK	Yes	0.33 V Fixed	2.39 V Fixed	No	Yes	Type 2	3 hours total			4.2
AL	No	0.33 V Fixed	2.39 V Fixed	No	Yes	Type 2	3 hours total			4.2
BM	Yes	30% of V_{IN}	60% of V_{IN}	Yes	Yes	Type 1	25 minutes	1 hour	2 hours	4.37
BN	No	30% of V_{IN}	60% of V_{IN}	Yes	Yes	Type 1	25 minutes	1 hour	2 hours	4.37
BO	Yes	0.33 V Fixed	2.39 V Fixed	Yes	Yes	Type 2	25 minutes	1 hour	2 hours	4.37
BP	No	0.33 V Fixed	2.39 V Fixed	Yes	Yes	Type 2	25 minutes	1 hour	2 hours	4.37

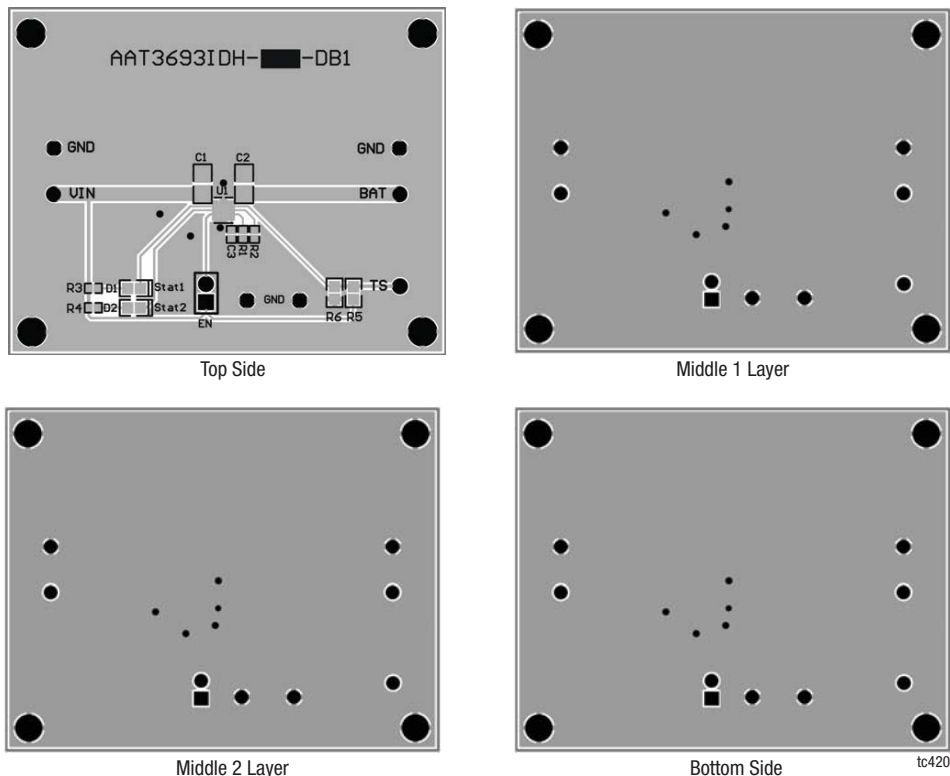
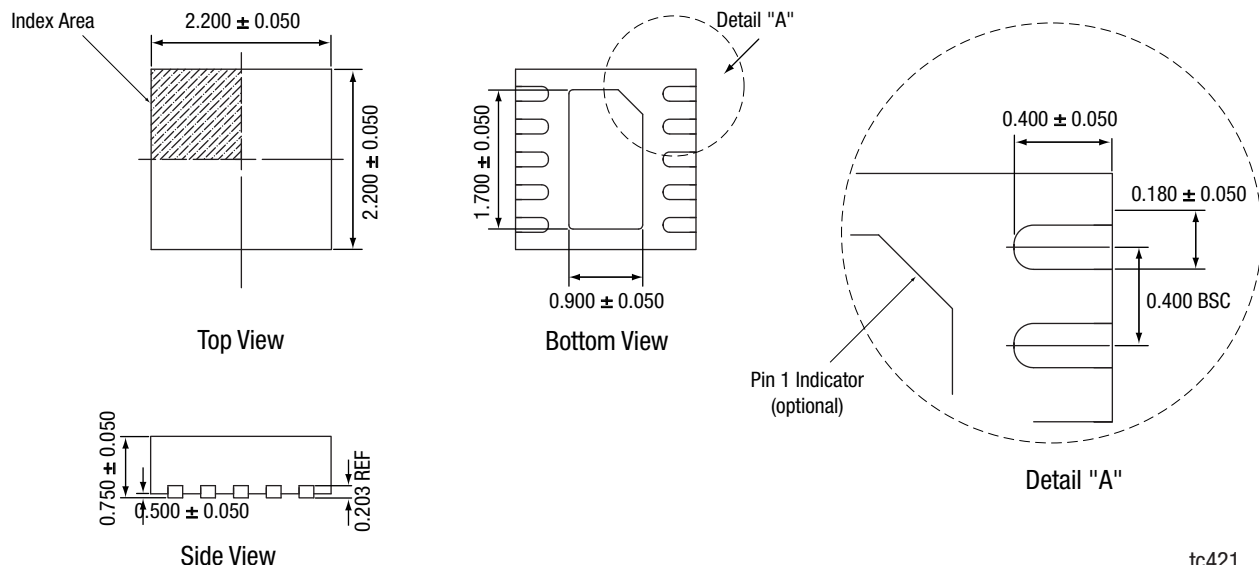
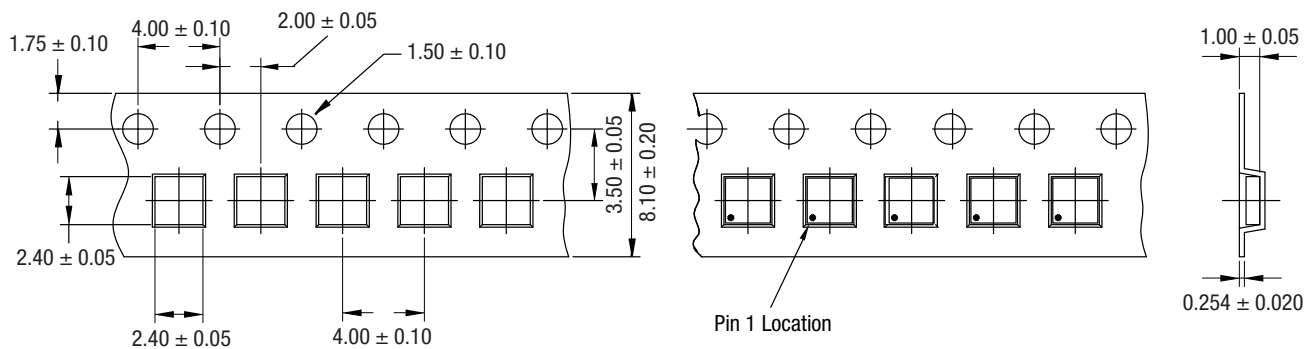

Figure 32. AAT3693 Evaluation Board Layer Details



tc421

Figure 33. AAT3693 Package Dimensions



All dimensions are in millimeters.

tc422

Figure 34. AAT3693 Tape and Reel Dimensions

Ordering Information

Model Name	Part Marking ¹	Manufacturing Part Number ²	Evaluation Board Part Number
AAT3693: 1.6 A Li-Ion/Polymer Battery Charger	5FXY	AAT3693IDH-AA-T1	AAT3693IDH-AA-EVB
	7DXY	AAT3693IDH-AB-T1	AAT3693IDH-AB-EVB
		AAT3693IDH-AC-T1	AAT3693IDH-AC-EVB
		AAT3693IDH-AD-T1	AAT3693IDH-AD-EVB
		AAT3693IDH-AE-T1	AAT3693IDH-AE-EVB
		AAT3693IDH-AF-T1	AAT3693IDH-AF-EVB
		AAT3693IDH-AG-T1	AAT3693IDH-AG-EVB
		AAT3693IDH-AH-T1	AAT3693IDH-AH-EVB
	5GXY	AAT3693IDH-AI-T1	AAT3693IDH-AI-EVB
	7EXY	AAT3693IDH-AJ-T1	AAT3693IDH-AJ-EVB
		AAT3693IDH-AK-T1	AAT3693IDH-AK-EVB
		AAT3693IDH-AL-T1	AAT3693IDH-AL-EVB
		AAT3693IDH-BM-T1	AAT3693IDH-BM-EVB
		AAT3693IDH-BN-T1	AAT3693IDH-BN-EVB
		AAT3693IDH-BO-T1	AAT3693IDH-BO-EVB
		AAT3693IDH-BP-T1	AAT3693IDH-BP-EVB

¹ : XYY = assembly and date code.

² Sample stock is generally held on part numbers listed in **BOLD**.

Copyright © 2012, 2014, 2016 Skyworks Solutions, Inc. All Rights Reserved.

Information in this document is provided in connection with Skyworks Solutions, Inc. ("Skyworks") products or services. These materials, including the information contained herein, are provided by Skyworks as a service to its customers and may be used for informational purposes only by the customer. Skyworks assumes no responsibility for errors or omissions in these materials or the information contained herein. Skyworks may change its documentation, products, services, specifications or product descriptions at any time, without notice. Skyworks makes no commitment to update the materials or information and shall have no responsibility whatsoever for conflicts, incompatibilities, or other difficulties arising from any future changes.

No license, whether express, implied, by estoppel or otherwise, is granted to any intellectual property rights by this document. Skyworks assumes no liability for any materials, products or information provided hereunder, including the sale, distribution, reproduction or use of Skyworks products, information or materials, except as may be provided in Skyworks Terms and Conditions of Sale.

THE MATERIALS, PRODUCTS AND INFORMATION ARE PROVIDED "AS IS" WITHOUT WARRANTY OF ANY KIND, WHETHER EXPRESS, IMPLIED, STATUTORY, OR OTHERWISE, INCLUDING FITNESS FOR A PARTICULAR PURPOSE OR USE, MERCHANTABILITY, PERFORMANCE, QUALITY OR NON-INFRINGEMENT OF ANY INTELLECTUAL PROPERTY RIGHT; ALL SUCH WARRANTIES ARE HEREBY EXPRESSLY DISCLAIMED. SKYWORKS DOES NOT WARRANT THE ACCURACY OR COMPLETENESS OF THE INFORMATION, TEXT, GRAPHICS OR OTHER ITEMS CONTAINED WITHIN THESE MATERIALS. SKYWORKS SHALL NOT BE LIABLE FOR ANY DAMAGES, INCLUDING BUT NOT LIMITED TO ANY SPECIAL, INDIRECT, INCIDENTAL, STATUTORY, OR CONSEQUENTIAL DAMAGES, INCLUDING WITHOUT LIMITATION, LOST REVENUES OR LOST PROFITS THAT MAY RESULT FROM THE USE OF THE MATERIALS OR INFORMATION, WHETHER OR NOT THE RECIPIENT OF MATERIALS HAS BEEN ADVISED OF THE POSSIBILITY OF SUCH DAMAGE.

Skyworks products are not intended for use in medical, lifesaving or life-sustaining applications¹ or other equipment in which the failure of the Skyworks products could lead to personal injury, death, physical or environmental damage. Skyworks customers using or selling Skyworks products for use in such applications do so at their own risk and agree to fully indemnify Skyworks for any damages resulting from such improper use or sale.

Customers are responsible for their products and applications using Skyworks products, which may deviate from published specifications as a result of design defects, errors, or operation of products outside of published parameters or design specifications. Customers should include design and operating safeguards to minimize these and other risks. Skyworks assumes no liability for applications assistance, customer product design, or damage to any equipment resulting from the use of Skyworks products outside of stated published specifications or parameters.

Skyworks and the Skyworks symbol are trademarks or registered trademarks of Skyworks Solutions, Inc., in the United States and other countries. Third-party brands and names are for identification purposes only, and are the property of their respective owners. Additional information, including relevant terms and conditions, posted at www.skyworksinc.com, are incorporated by reference.