



Chipsmall Limited consists of a professional team with an average of over 10 year of expertise in the distribution of electronic components. Based in Hongkong, we have already established firm and mutual-benefit business relationships with customers from,Europe,America and south Asia,supplying obsolete and hard-to-find components to meet their specific needs.

With the principle of “Quality Parts,Customers Priority,Honest Operation,and Considerate Service”,our business mainly focus on the distribution of electronic components. Line cards we deal with include Microchip,ALPS,ROHM,Xilinx,Pulse,ON,Everlight and Freescale. Main products comprise IC,Modules,Potentiometer,IC Socket,Relay,Connector.Our parts cover such applications as commercial,industrial, and automotives areas.

We are looking forward to setting up business relationship with you and hope to provide you with the best service and solution. Let us make a better world for our industry!



Contact us

Tel: +86-755-8981 8866 Fax: +86-755-8427 6832

Email & Skype: info@chipsmall.com Web: www.chipsmall.com

Address: A1208, Overseas Decoration Building, #122 Zhenhua RD., Futian, Shenzhen, China



Wire Wound Chip Balun Wide Band Transformer

ABT-8



RoHS / RoHS II Compliant



2.0 x 1.2 x 1.2mm

FEATURES

- Small size and low profile SMT package
- Low insertion loss within working frequency range
- 1:1 impedance ratio
- Excellent solderability

APPLICATIONS:

- Balanced unbalanced transformation between antenna and cable for TV tuner, STB

ELECTRICAL SPECIFICATIONS:

Operating Temperature: -40°C to +85°C

Storage Temperature: -10°C to +40°C, 70% RH max. in tape and reel

Part Number	Frequency Range (MHz)	Unbalance /Balance Impedance (ohm)	DC Resistance (Ω) Max	Rated Current (mA) Max	Insertion Loss max (dB)	CMRR min (dB)	Rated Voltage (Vdc)	Withstand Voltage (Vdc)	Insulation Resistance Min. (MΩ)
ABT-8-75-1	45~870	75/75	0.80	200	1.0	20	50	125	10
ABT-8-50-1	45~870	50/50	0.80	200	1.2	20	50	125	10
ABT-8-75-2	50~1200	75/75	0.40	300	1.5	20	50	125	10
ABT-8-75-3	1000~1500	75/75	0.42	290	1.4	20	50	125	10

ELECTRICAL CHARACTERISTIC CURVES

ABT-8-75-1

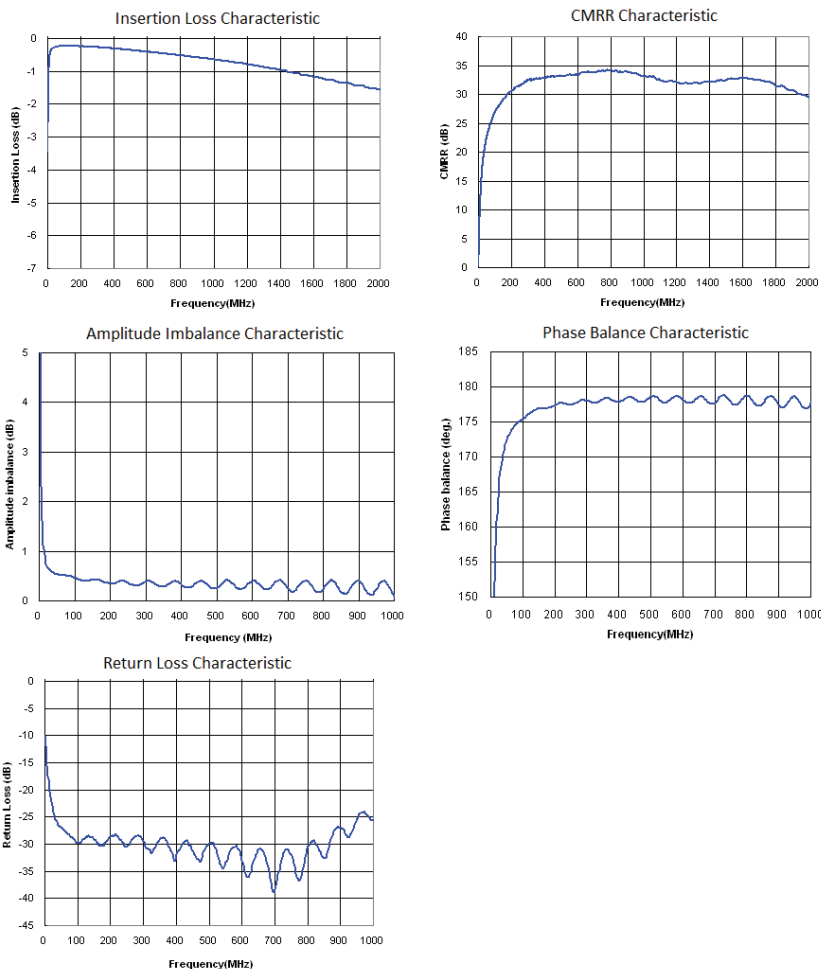

Wire Wound Chip Balun Wide Band Transformer

ABT-8



RoHS / RoHS II Compliant



2.0 x 1.2 x 1.2mm

ELECTRICAL CHARACTERISTIC CURVES

ABT-8-50-1

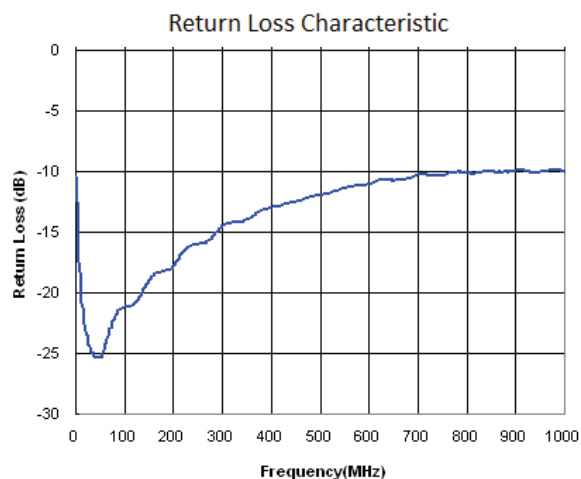
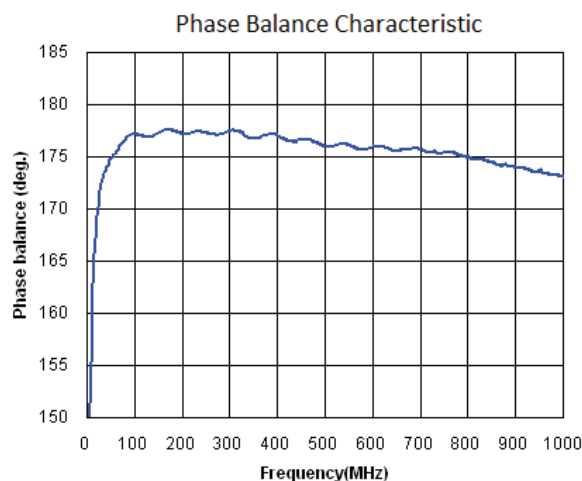
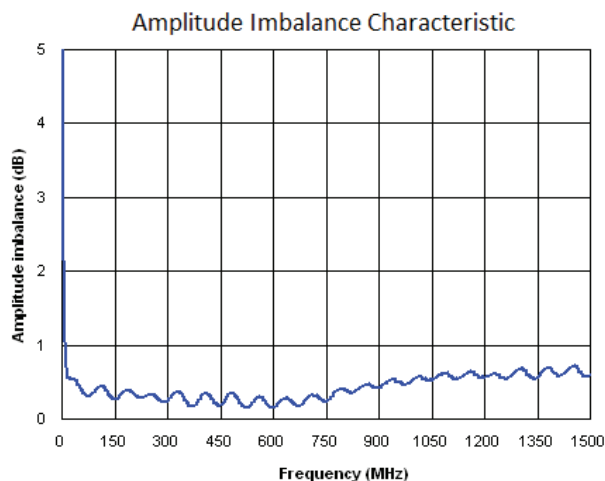
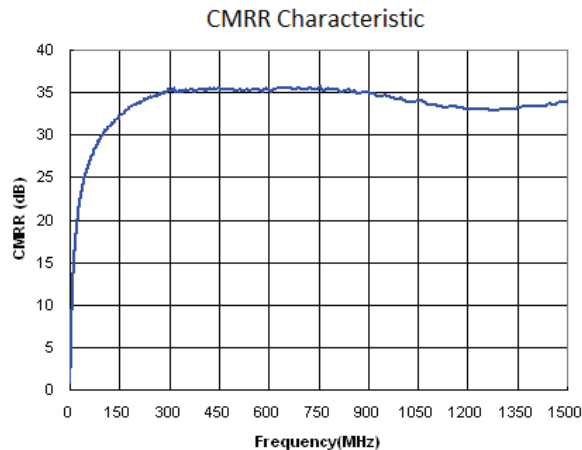
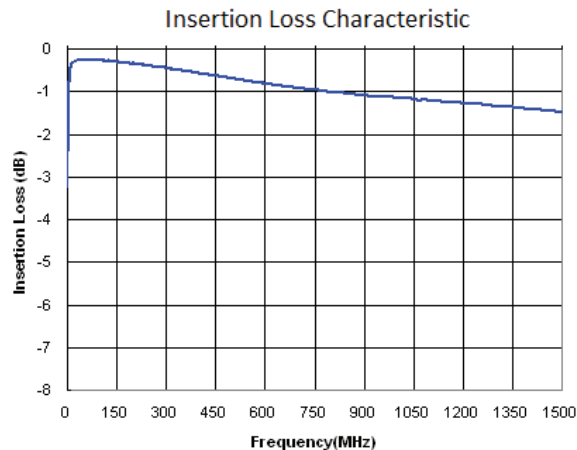

Wire Wound Chip Balun Wide Band Transformer

ABT-8



RoHS / RoHS II Compliant



2.0 x 1.2 x 1.2mm

ELECTRICAL CHARACTERISTIC CURVES

ABT-8-75-2

Insertion Loss Characteristic

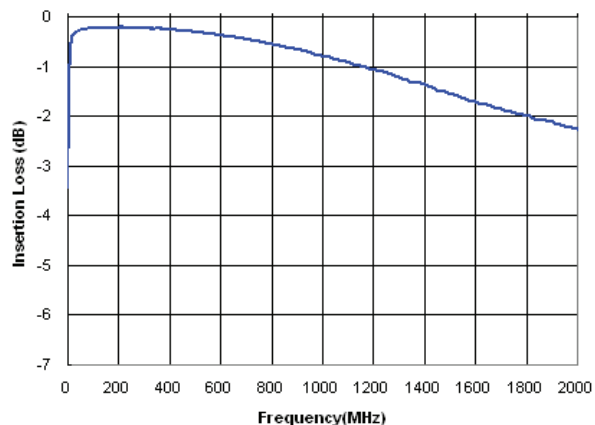

CMRR Characteristic

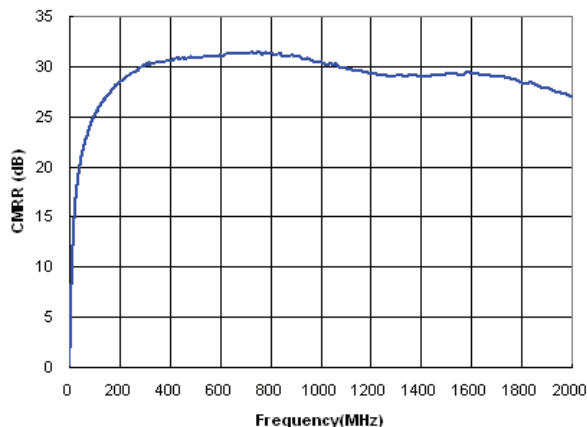

Amplitude Imbalance Characteristic

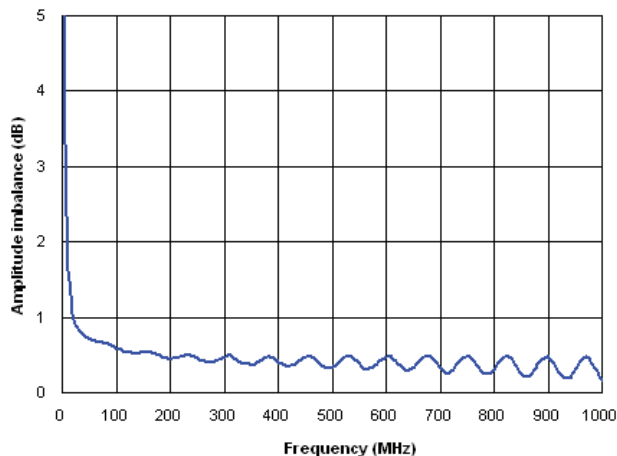

Phase Balance Characteristic

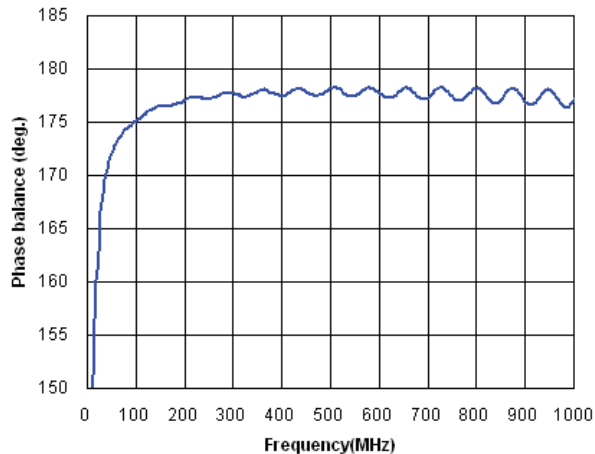

Return Loss Characteristic

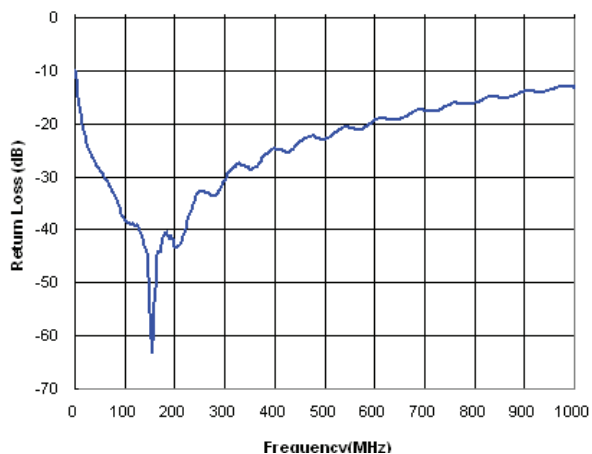

Wire Wound Chip Balun Wide Band Transformer

ABT-8



RoHS / RoHS II Compliant



2.0 x 1.2 x 1.2mm

ELECTRICAL CHARACTERISTIC CURVES

ABT-8-75-3

Insertion Loss Characteristic

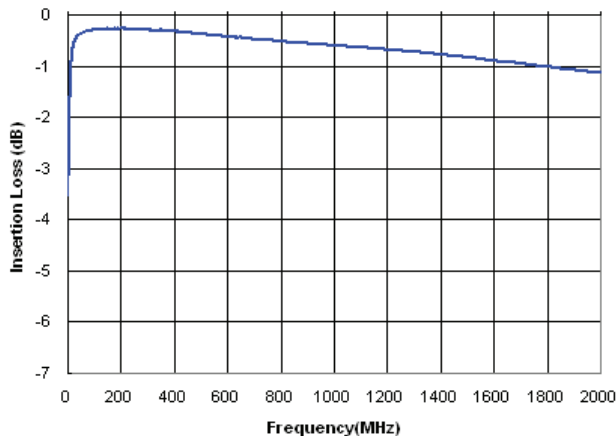

CMRR Characteristic

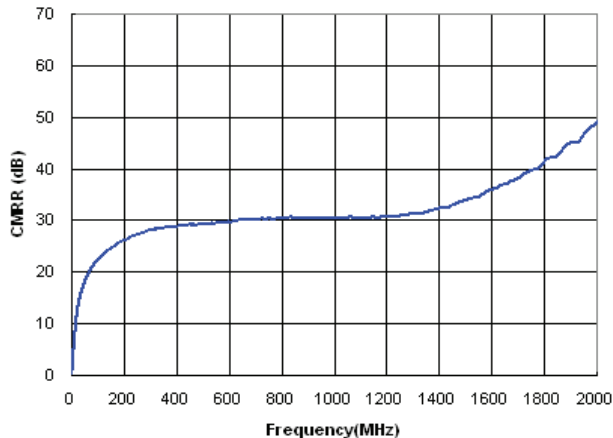

Amplitude Imbalance Characteristic

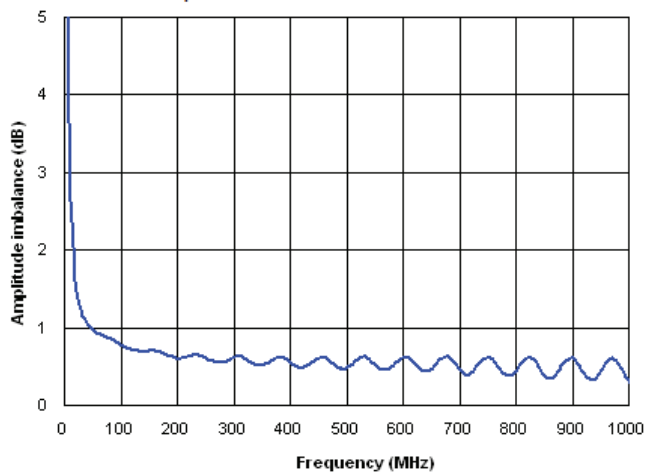

Phase Balance Characteristic

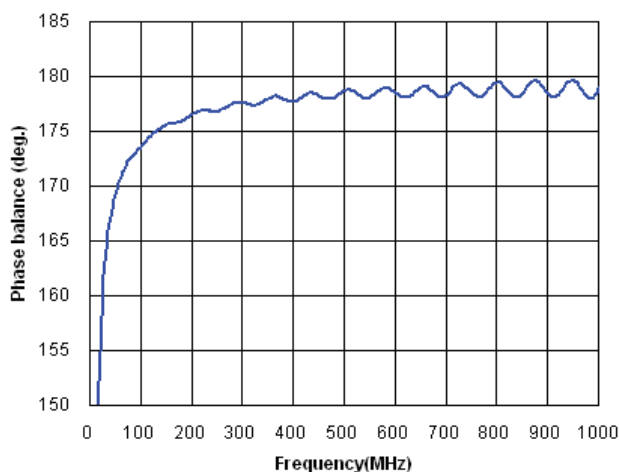

Return Loss Characteristic

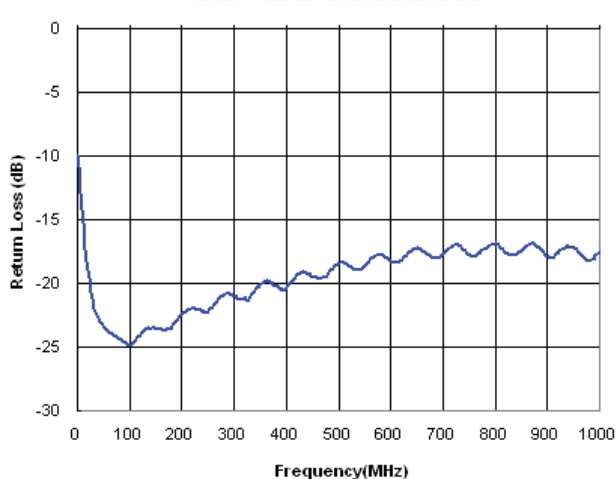

Wire Wound Chip Balun Wide Band Transformer

ABT-8

 RoHS / RoHS II Compliant



2.0 x 1.2 x 1.2mm

PART IDENTIFICATION:

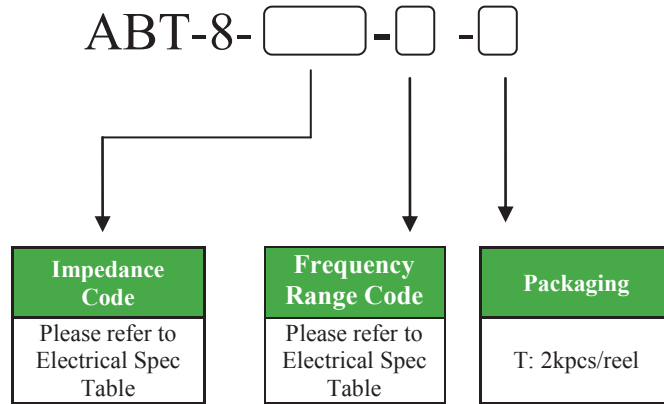

OUTLINE DIMENSIONS:

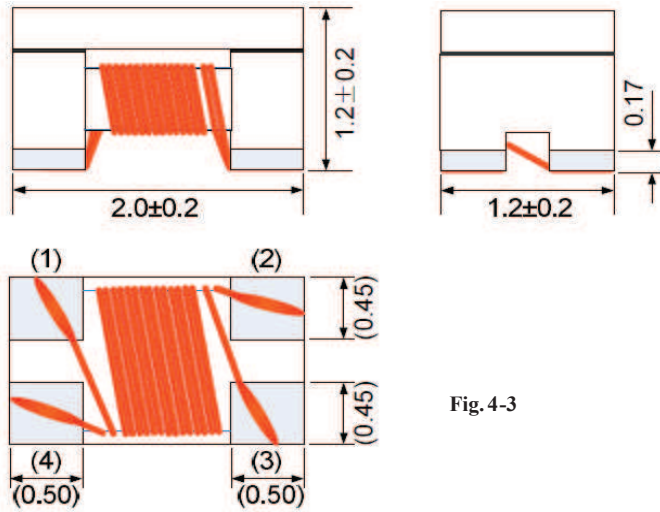

Recommended Land Pattern

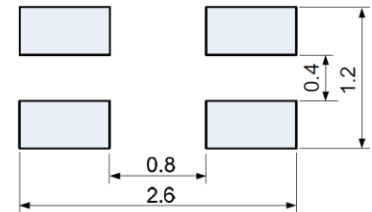

Schematic

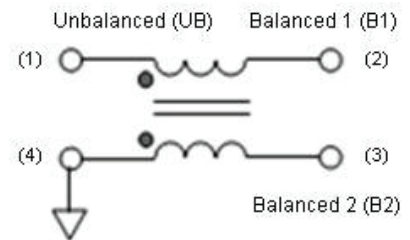

Material Structure

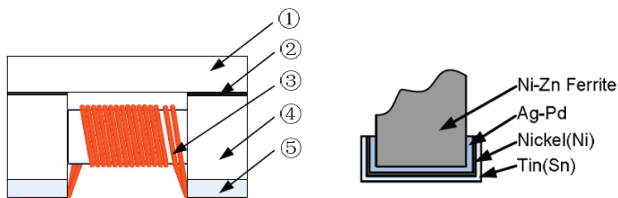

No.	Part Name	Material Name
①	Lid	Ni-Zn Ferrite
②	Epoxy	Epoxy resin
③	Wire	Polyurethane system enameled copper wire
④	Core	Ni-Zn Ferrite
⑤	Electrode	(Ag-Pd)+Ni+Sn plating

Dimension: mm

Wire Wound Chip Balun Wide Band Transformer

ABT-8



RoHS / RoHS II Compliant



2.0 x 1.2 x 1.2mm

REFLOW PROFILE:

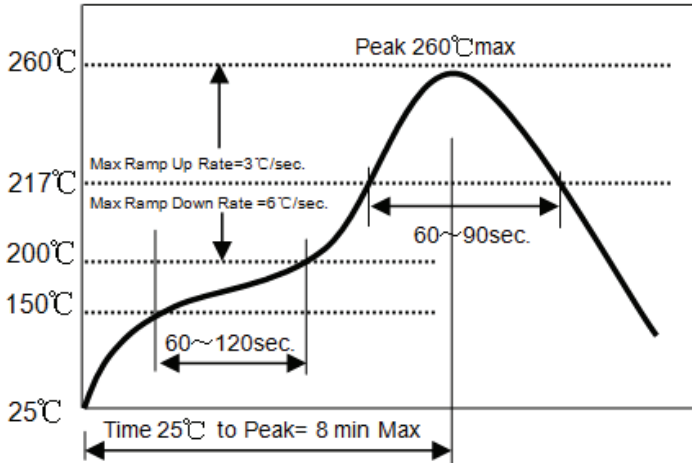

- △ Preheat condition: 150~200°C/60~120sec.
- △ Allowed time above 217°C: 60~90sec.
- △ Max temp: 260°C
- △ Max time at max temp: 10sec.
- △ Solder paste: Sn/3.0Ag/0.5Cu
- △ Allowed Reflow time: 2 times max.

TAPE & REEL:

T= tape and reel (2,000pcs/reel)

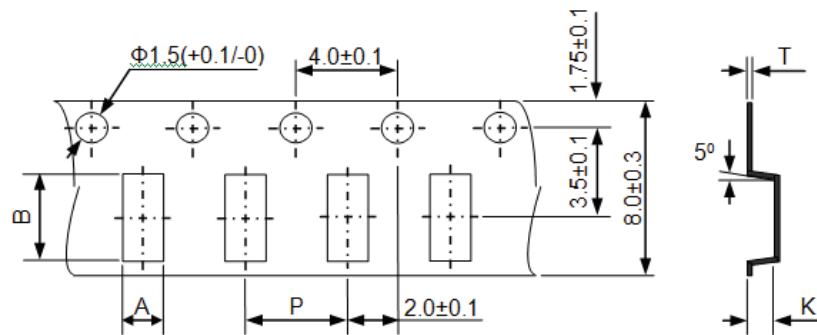

A	B	P	K	T
1.55±0.2	2.25±0.2	4.0±0.1	1.45±0.1	0.2±0.1

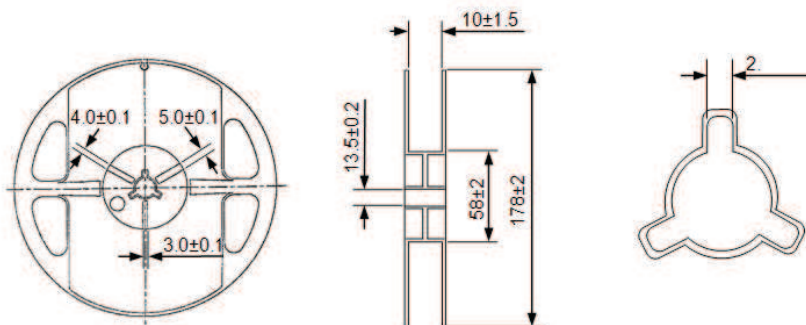

Dimension: mm

ATTENTION: Abracon Corporation's products are COTS – Commercial-Off-The-Shelf products; suitable for Commercial, Industrial and, where designated, Automotive Applications. Abracon's products are not specifically designed for Military, Aviation, Aerospace, Life-dependant Medical applications or any application requiring high reliability where component failure could result in loss of life and/or property. For applications requiring high reliability and/or presenting an extreme operating environment, written consent and authorization from Abracon Corporation is required. Please contact Abracon Corporation for more information.

ABRACON IS
ISO9001:2008
CERTIFIED



2 Faraday, Suite# B | Irvine | CA 92618 Revised: 02.04.15

Ph. 949.546.8000 | Fax. 949.546.8001

Visit www.abracon.com for Terms and Conditions of Sale