



Chipsmall Limited consists of a professional team with an average of over 10 year of expertise in the distribution of electronic components. Based in Hongkong, we have already established firm and mutual-benefit business relationships with customers from,Europe,America and south Asia,supplying obsolete and hard-to-find components to meet their specific needs.

With the principle of “Quality Parts,Customers Priority,Honest Operation,and Considerate Service”,our business mainly focus on the distribution of electronic components. Line cards we deal with include Microchip,ALPS,ROHM,Xilinx,Pulse,ON,Everlight and Freescale. Main products comprise IC,Modules,Potentiometer,IC Socket,Relay,Connector.Our parts cover such applications as commercial,industrial, and automotives areas.

We are looking forward to setting up business relationship with you and hope to provide you with the best service and solution. Let us make a better world for our industry!



Contact us

Tel: +86-755-8981 8866 Fax: +86-755-8427 6832

Email & Skype: info@chipsmall.com Web: www.chipsmall.com

Address: A1208, Overseas Decoration Building, #122 Zhenhua RD., Futian, Shenzhen, China



WiFi + GPS Multiband Ceramic Chip Antenna



ACAG0301-15752450-T



3.2 x 1.6 x 1.2mm
RoHS/RoHS II Compliant
MSL = 1

FEATURES

- Made using LTCC (low temperature co-fired ceramic) technology
- Gain of 1.21dBi | 3.18dBi
- 1575MHz and 2450MHz frequency bands
- Small form factor 3.2 x 1.6 x 1.2mm
- Omni-directional

APPLICATIONS

- IoT and wearable
- GPS devices
- Wifi
- Bluetooth
- ISM applications

ELECTRICAL CHARACTERISTICS

Item	Specification	
Frequency	1575 MHz	2450 MHz
Bandwidth	20 MHz typ (1565~1585 MHz)	100 MHz (2400~2500 MHz)
Peak Gain	1.21 dBi	3.18 dBi
Return Loss	≥10 dB	
Impedance	50 Ω	
Operating Temperature Range	-40°C ~+ 85°C	

MECHANICAL DIMENSION (mm)

Antenna Dimension

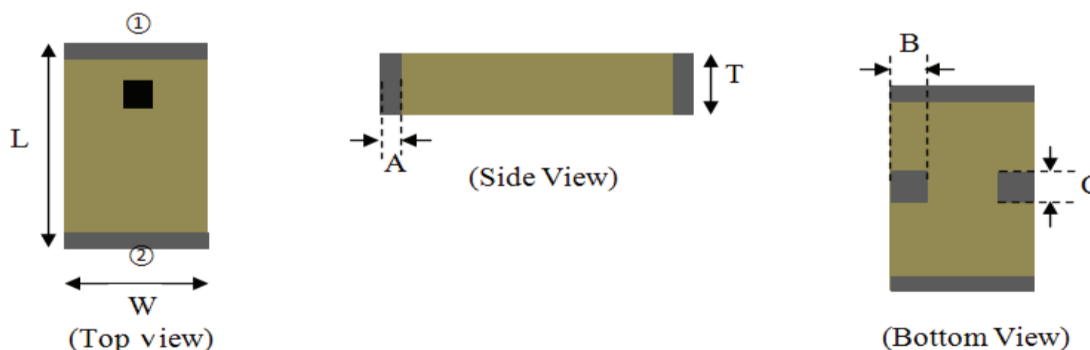

Number	Terminal Name	Number	Terminal Name
①	INPUT-GPS	③	GND
②	INPUT-2.4GHz	④	GND

Symbols	L	W	T	A	B	C
Dimensions	3.2+/-0.2	1.6+/-0.2	1.2+/-0.15	0.2+/-0.15	0.5+/-0.15	0.47+/-0.15

WiFi + GPS Multiband Ceramic Chip Antenna

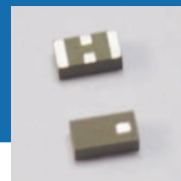

ACAG0301-15752450-T



3.2 x 1.6 x 1.2mm
RoHS/RoHS II Compliant
MSL = 1

MECHANICAL DIMENSIONS (mm)

Layout Dimension

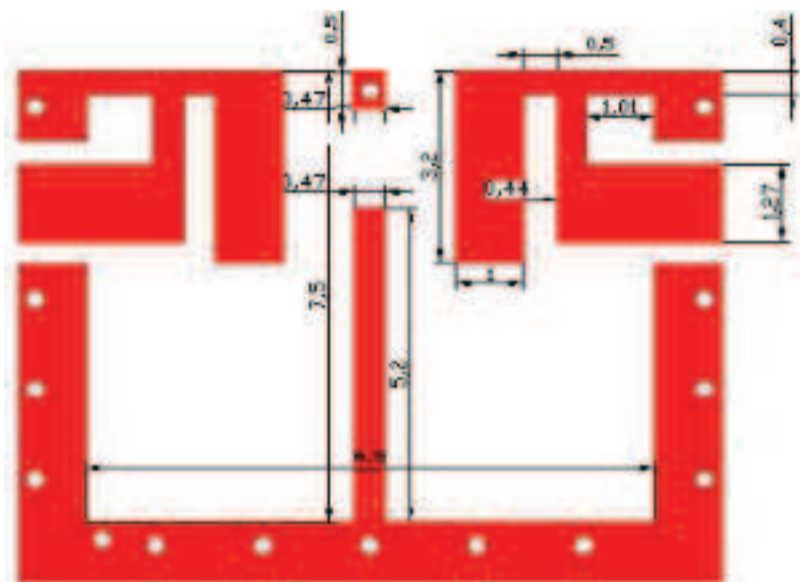

Top

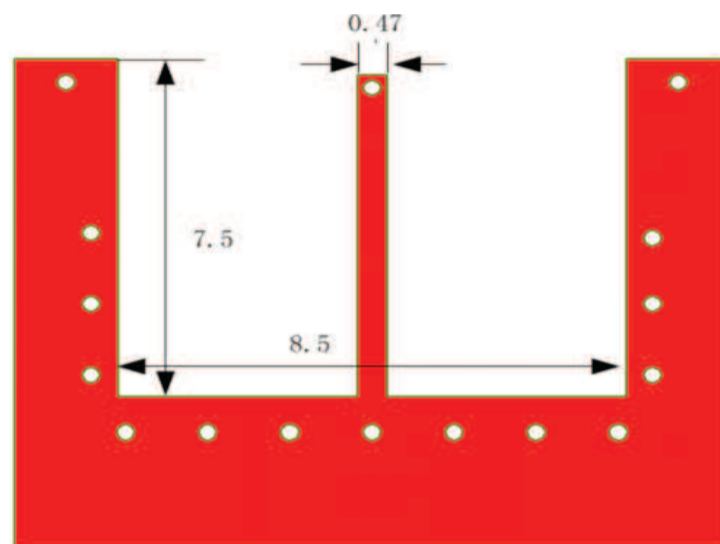

Bottom

EVALUATION BOARD AND MATCHING CIRCUITS

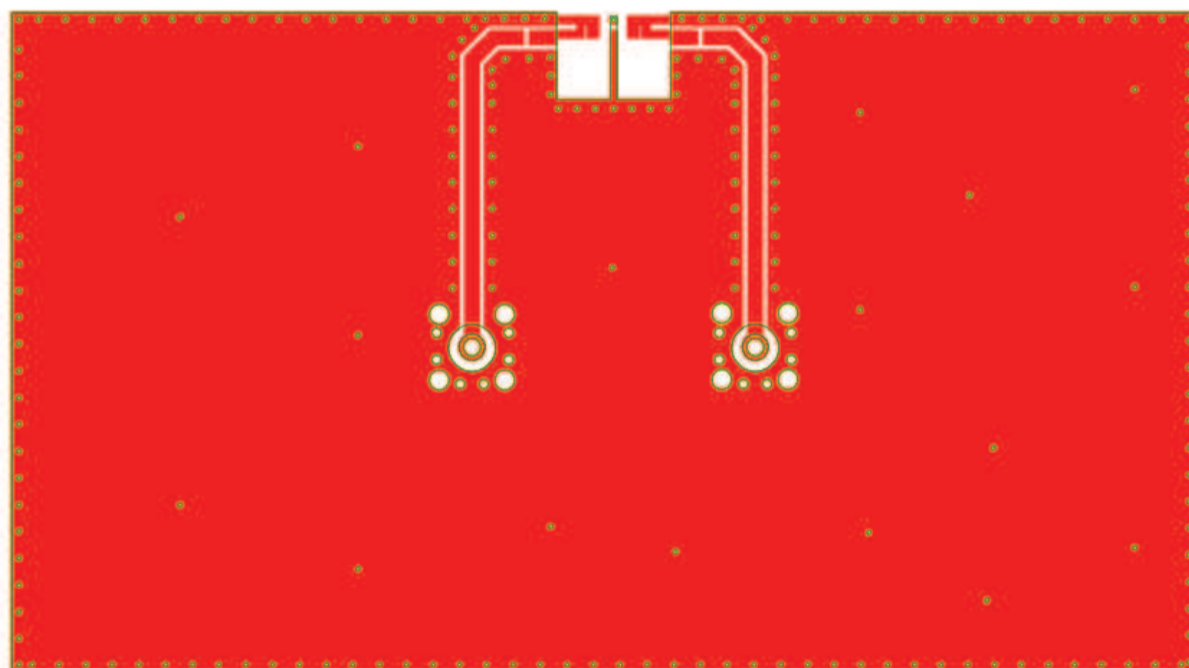

GPS

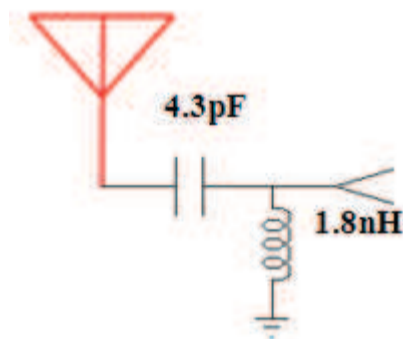

2.45G

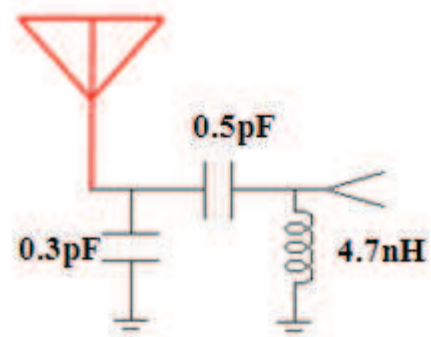

WiFi + GPS Multiband Ceramic Chip Antenna

ACAG0301-15752450-T

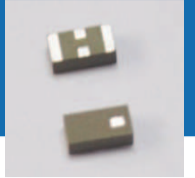

3.2 x 1.6 x 1.2mm
RoHS/RoHS II Compliant

MSL = 1

ANTENNA RESPONSE – RETURN LOSS S11

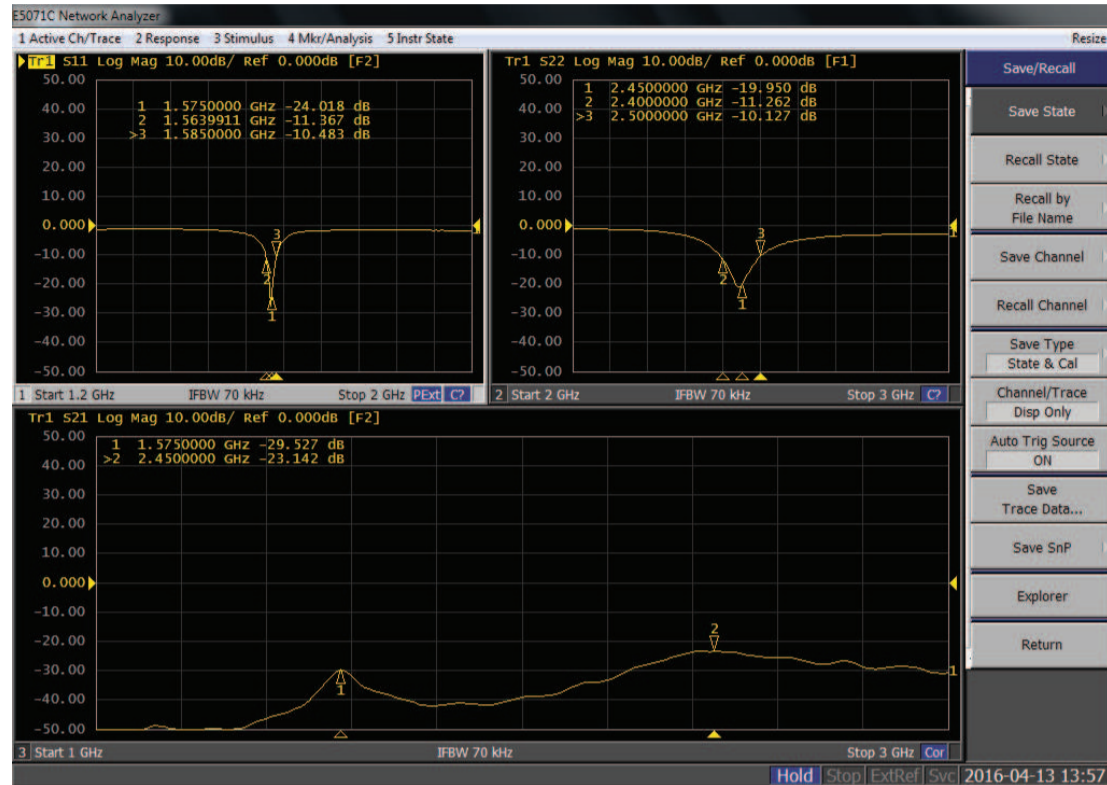

RADIATION PATTERNS

Coordinates

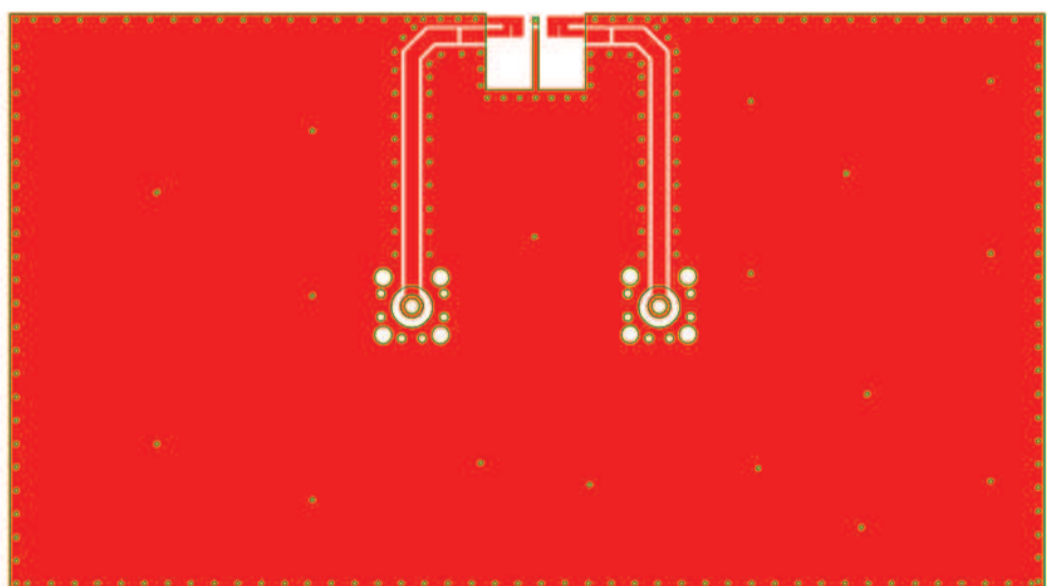
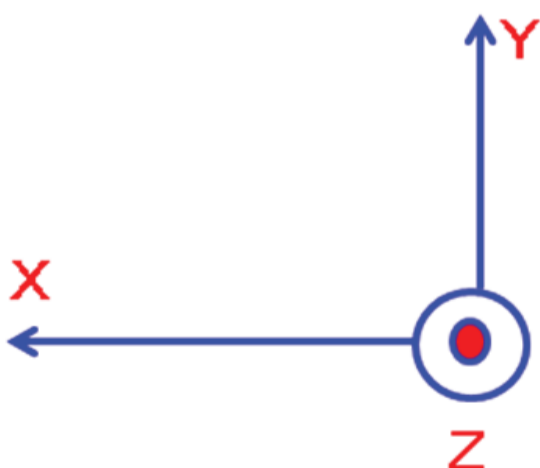

WiFi + GPS Multiband Ceramic Chip Antenna

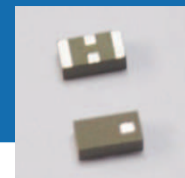

ACAG0301-15752450-T



3.2 x 1.6 x 1.2mm
RoHS/RoHS II Compliant
MSL = 1

RADIATION PATTERNS

GPS X-Z Plane

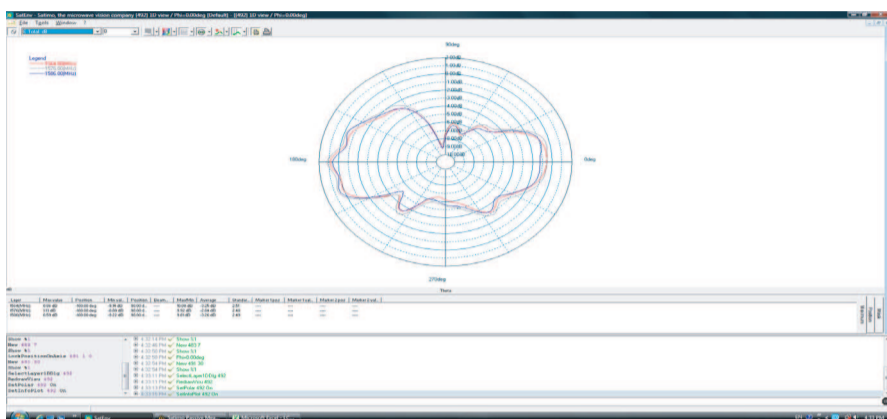

GPS Y-Z Plane

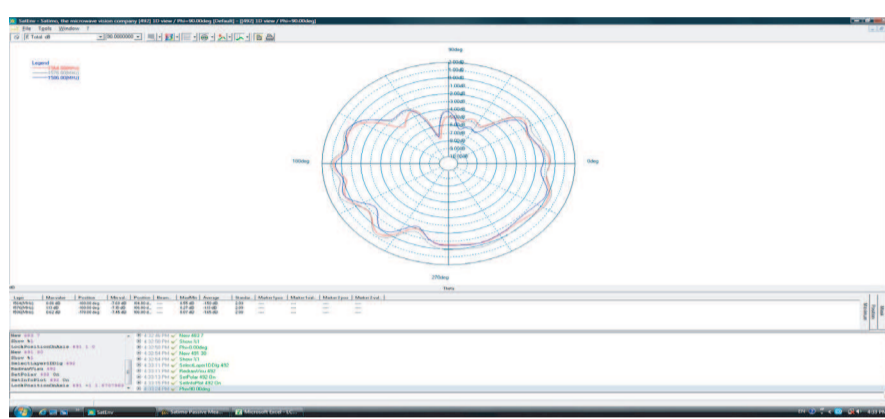

GPS X-Y Plane

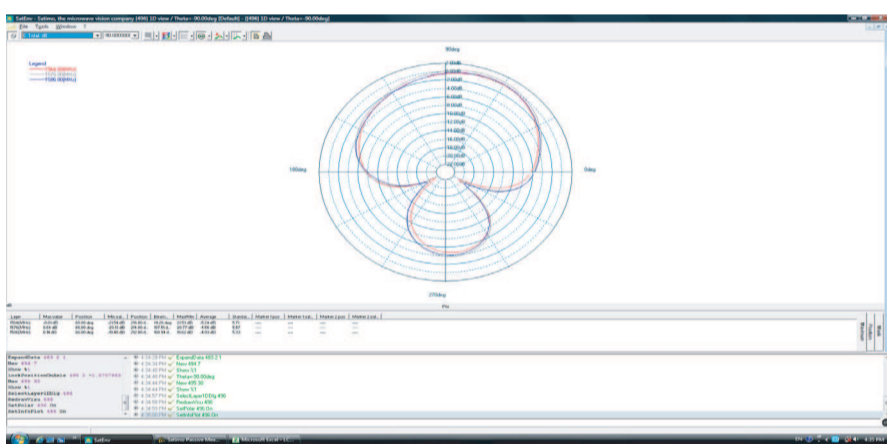

2.45G X-Z Plane

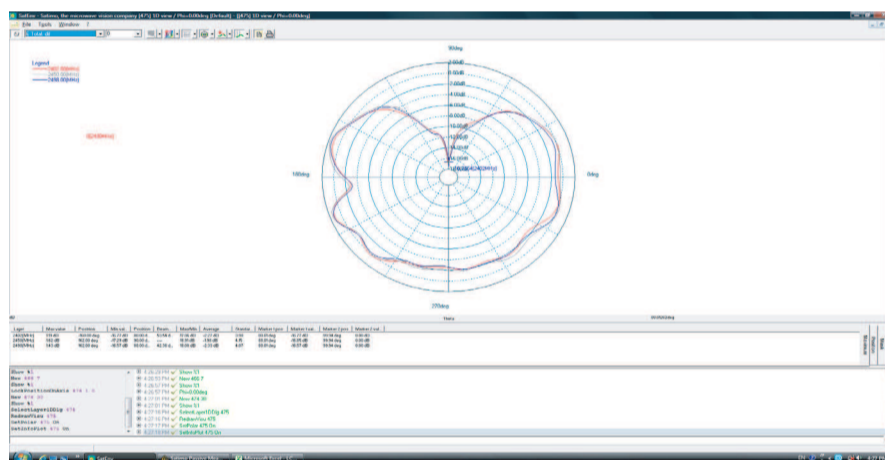

2.45G Y-Z Plane

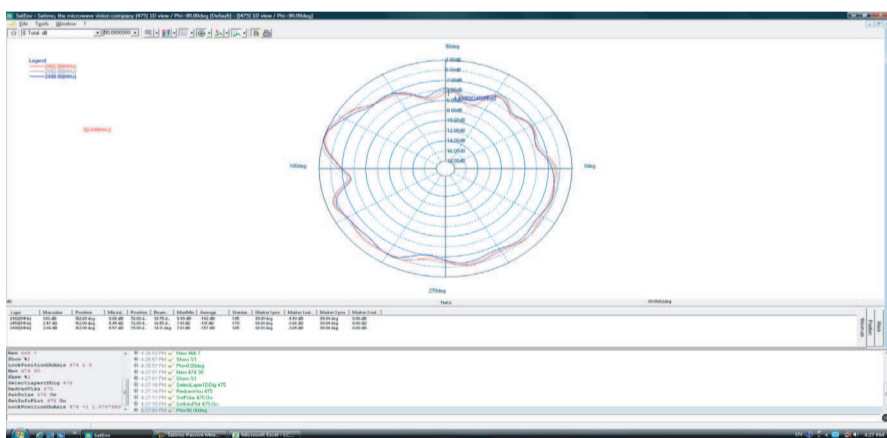

2.45G X-Y Plane

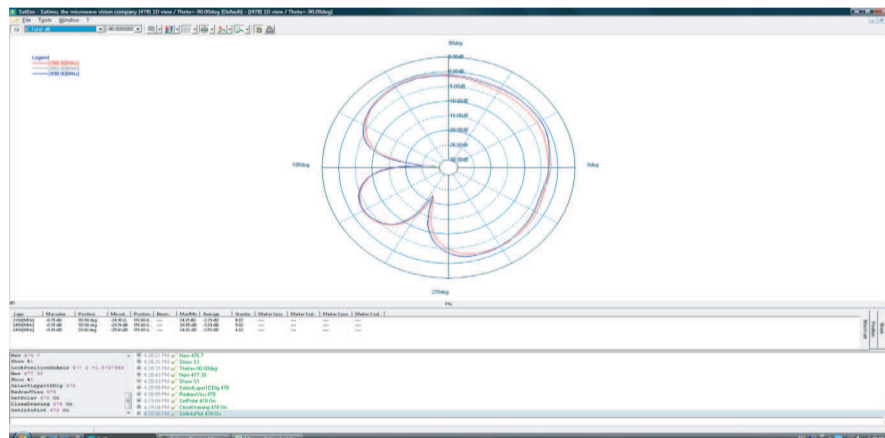

WiFi + GPS Multiband Ceramic Chip Antenna

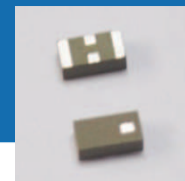

ACAG0301-15752450-T



3.2 x 1.6 x 1.2mm
RoHS/RoHS II Compliant
MSL = 1

3D PATTERNS

GPS

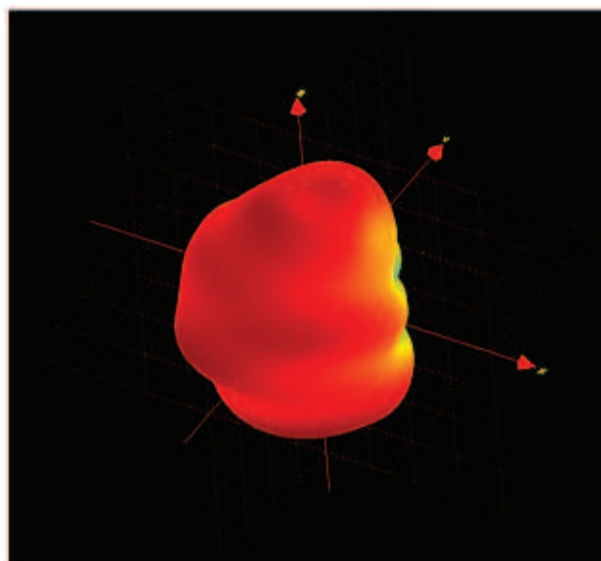

Frequency (MHz)	1565	1575	1585
Avg. Gain (dBi)	-1.5	-1.13	-1.65
Peak Gain (dBi)	1.05	1.21	1.13
Efficiency (%)	53	57	52

2.45 GHz

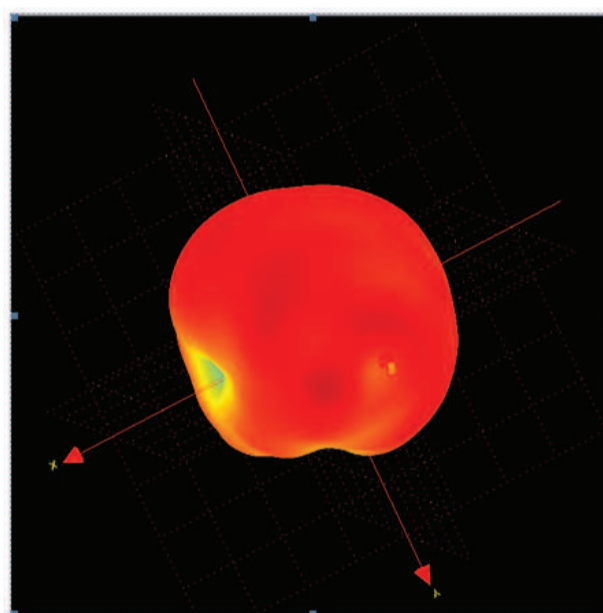

Frequency (MHz)	2400	2450	2500
Avg. Gain (dBi)	-1.42	-1.19	-1.57
Peak Gain (dBi)	2.87	3.18	2.96
Efficiency (%)	66	73	67

WiFi + GPS Multiband Ceramic Chip Antenna

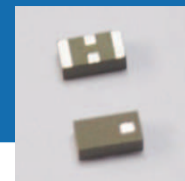

ACAG0301-15752450-T



3.2 x 1.6 x 1.2mm
RoHS/RoHS II Compliant
MSL = 1

REFLOW SOLDERING STANDARD CONDITION

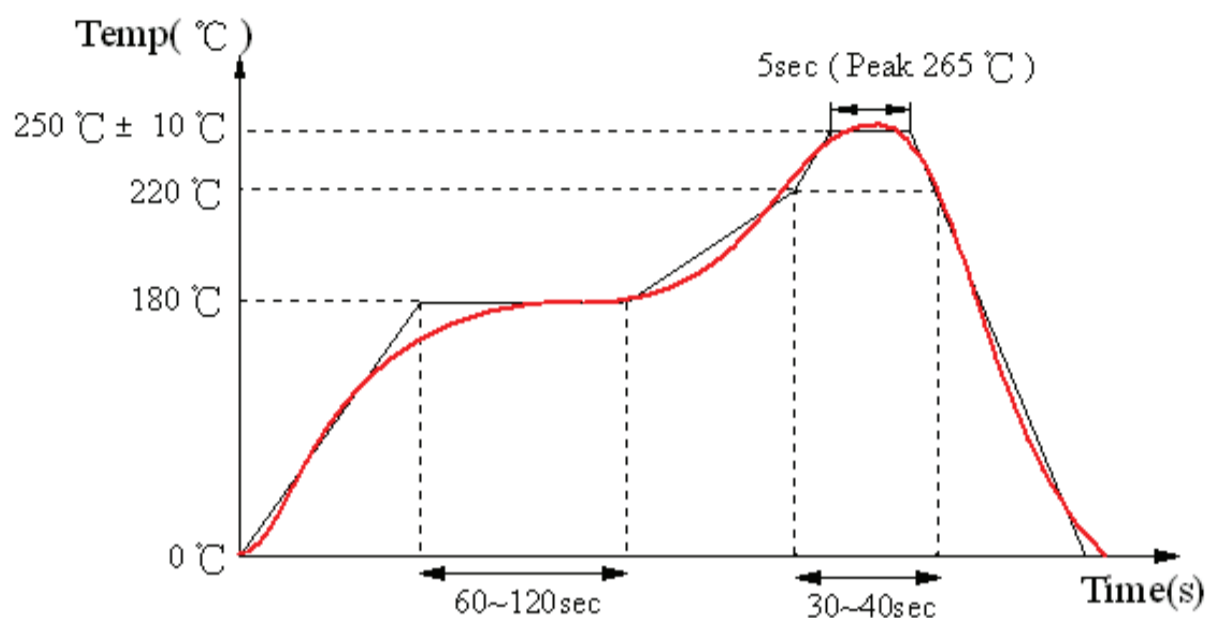

PACKAGING

Reel (3000 pcs/Reel)

Size of the carton: 330 x 210 x 210 mm

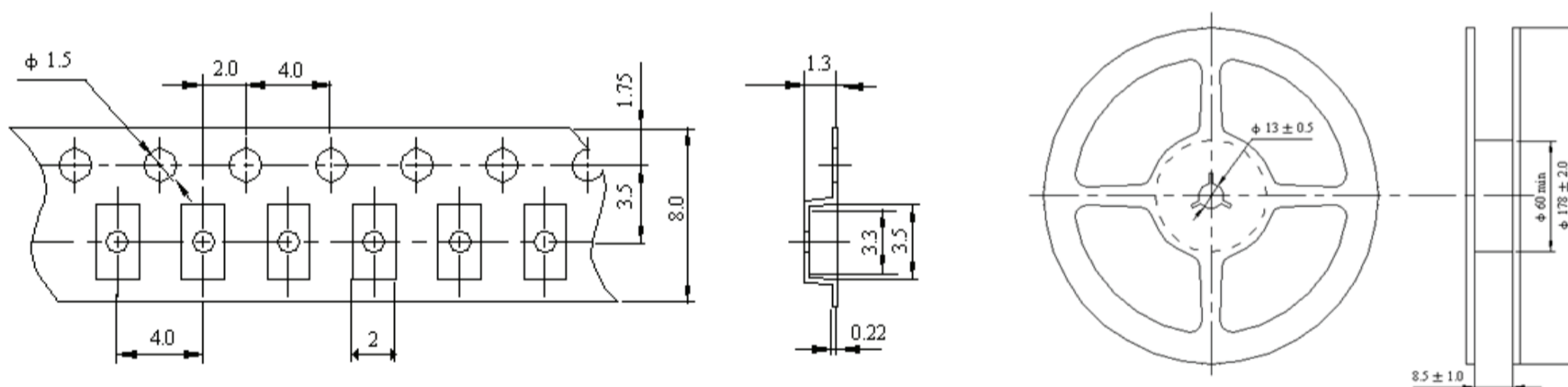

Dimensions: mm

Storage Temperature Range : <30 degree C, Humidity : <60%RH

MSL - 1

Oxidizable, 12 months in a vacuum sealed bag.

Once opened, please repack the unused items within 168 hours by re-seal package treatment.

WiFi + GPS Multiband Ceramic Chip Antenna

ACAG0301-15752450-T

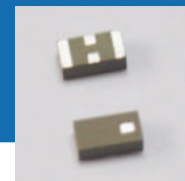

3.2 x 1.6 x 1.2mm
RoHS/RoHS II Compliant
MSL = 1

CAUTIONS

1. Static voltage

Static voltage between signal & ground may cause deterioration & destruction of the component. Please avoid static voltage.

2. Ultrasonic cleaning

Ultrasonic vibration may cause deterioration & destruction of the component. Please avoid ultrasonic cleaning.

3. Soldering

Only leads of the component may be soldered. Please avoid soldering to any other part of the component, such as on the patterns as this will change the performance of the antenna.