



Chipsmall Limited consists of a professional team with an average of over 10 year of expertise in the distribution of electronic components. Based in Hongkong, we have already established firm and mutual-benefit business relationships with customers from,Europe,America and south Asia,supplying obsolete and hard-to-find components to meet their specific needs.

With the principle of “Quality Parts,Customers Priority,Honest Operation,and Considerate Service”,our business mainly focus on the distribution of electronic components. Line cards we deal with include Microchip,ALPS,ROHM,Xilinx,Pulse,ON,Everlight and Freescale. Main products comprise IC,Modules,Potentiometer,IC Socket,Relay,Connector.Our parts cover such applications as commercial,industrial, and automotives areas.

We are looking forward to setting up business relationship with you and hope to provide you with the best service and solution. Let us make a better world for our industry!



## Contact us

Tel: +86-755-8981 8866 Fax: +86-755-8427 6832

Email & Skype: info@chipsmall.com Web: www.chipsmall.com

Address: A1208, Overseas Decoration Building, #122 Zhenhua RD., Futian, Shenzhen, China



**MATERIAL (INSULATOR/CONTACT)**  
**E = BLUE PBT/PHOSPHOR BRONZE**  
 OPERATING TEMP: -65°C TO +125°C  
 PROCESSING TEMP: WAVE / MANUAL SOLDERING  
**R = BROWN PPS/PHOSPHOR BRONZE**  
 OPERATING TEMP: -65°C TO +125°C  
 PROCESSING TEMP: 260°C FOR 20 SECS MAX  
**G = BLACK PA9T/PHOSPHOR BRONZE**  
 OPERATING TEMP: -65°C TO +125°C  
 PROCESSING TEMP: 260°C FOR 20 SECS MAX  
**H = BLUE PBT/BERYLLIUM COPPER**  
 OPERATING TEMP: -65°C TO +125°C  
 PROCESSING TEMP: WAVE / MANUAL SOLDERING  
**A = BROWN PPS/BERYLLIUM COPPER**  
 OPERATING TEMP: -65°C TO +150°C  
 PROCESSING TEMP: 260°C FOR 120 SECS MAX  
**J = BLACK PA9T/BERYLLIUM COPPER**  
 OPERATING TEMP: -65°C TO +150°C  
 PROCESSING TEMP: 260°C FOR 20 SECS MAX  
**T = BROWN PPS/ TREATED BERYLLIUM COPPER**  
 OPERATING TEMP: -65°C TO +175°C  
 PROCESSING TEMP: 260°C FOR 120 SECS MAX  
 ("Y" PLATING ONLY)  
 (CONSULT FACTORY FOR OTHER MATERIALS)

**PART NUMBER CODING**  
 C DKR -S

**MODIFICATION**  
 S1191 = .400 WIDE BODY TO ACCOMMODATE .093[2.36] PCB.  
 S1243 = .400 WIDE BODY TO ACCOMMODATE .062[1.57] PCB.

**MOUNTING STYLE**  
 H = .125" DIA. CLEARANCE HOLES  
 I = #4-40 THREADED INSERT (PAGE 2)  
 S = .125" DIA. SIDE MOUNTING (PAGE 2)  
 N = NO MOUNTING EARS (PAGE 2)  
 D = .250" EARS, FLUSH MOUNTING, .125" DIA HOLE (PAGE 2)  
 W = .430" EARS, FLUSH MOUNTING, .125" DIA HOLE (PAGE 2)  
 T = .250" EARS, FLUSH MOUNTING, #4-40 THREADED INSERT (PAGE 2)  
 X = .430" EARS, FLUSH MOUNTING, #4-40 THREADED INSERT (PAGE 2)

**NUMBER OF POSITIONS  
(CONTACT PER ROW)**

**PLATING**  
 ALL PLATINGS ARE LEAD FREE AND HAVE .000050" NICKEL UNDERPLATE

CONTACT SURFACE	TERMINATION
B = .000010" GOLD	.000100" PURE TIN, MATTE
C = .000030" GOLD	.000100" PURE TIN, MATTE
Y = .000030" GOLD	.000005" GOLD

REVISIONS				
REV.	ECO. NO	DESCRIPTION	DATE	BY
D	1850	ADD 'T' MATERIAL OPTION	11/11/2008	MNH
E	2899	ADD 04-POSITION, 'D', 'W', 'T', 'X' MTG OPTIONS, UPDATE BODY WIDTH AND DWG FORMAT	1/21/2014	JH

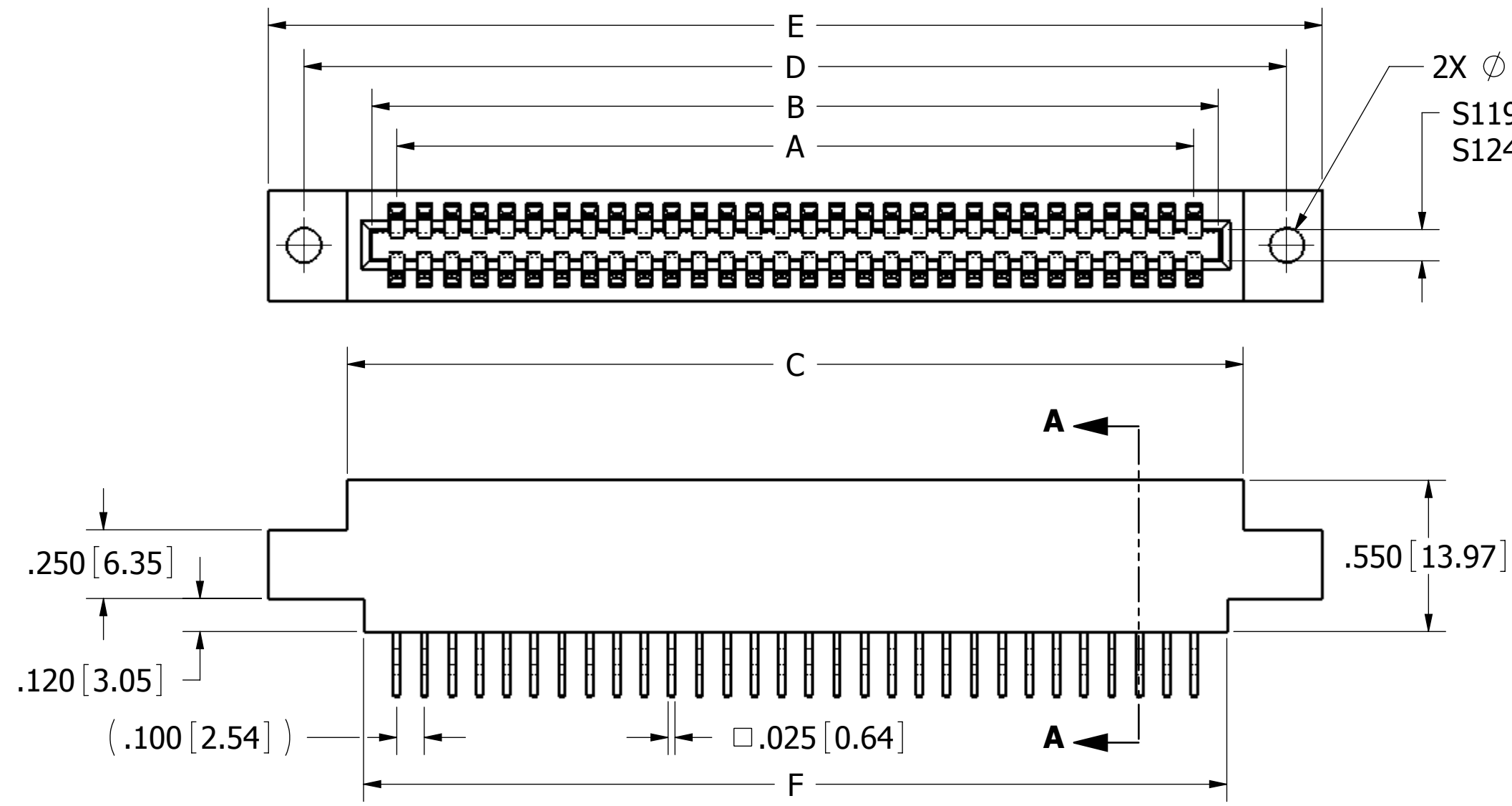
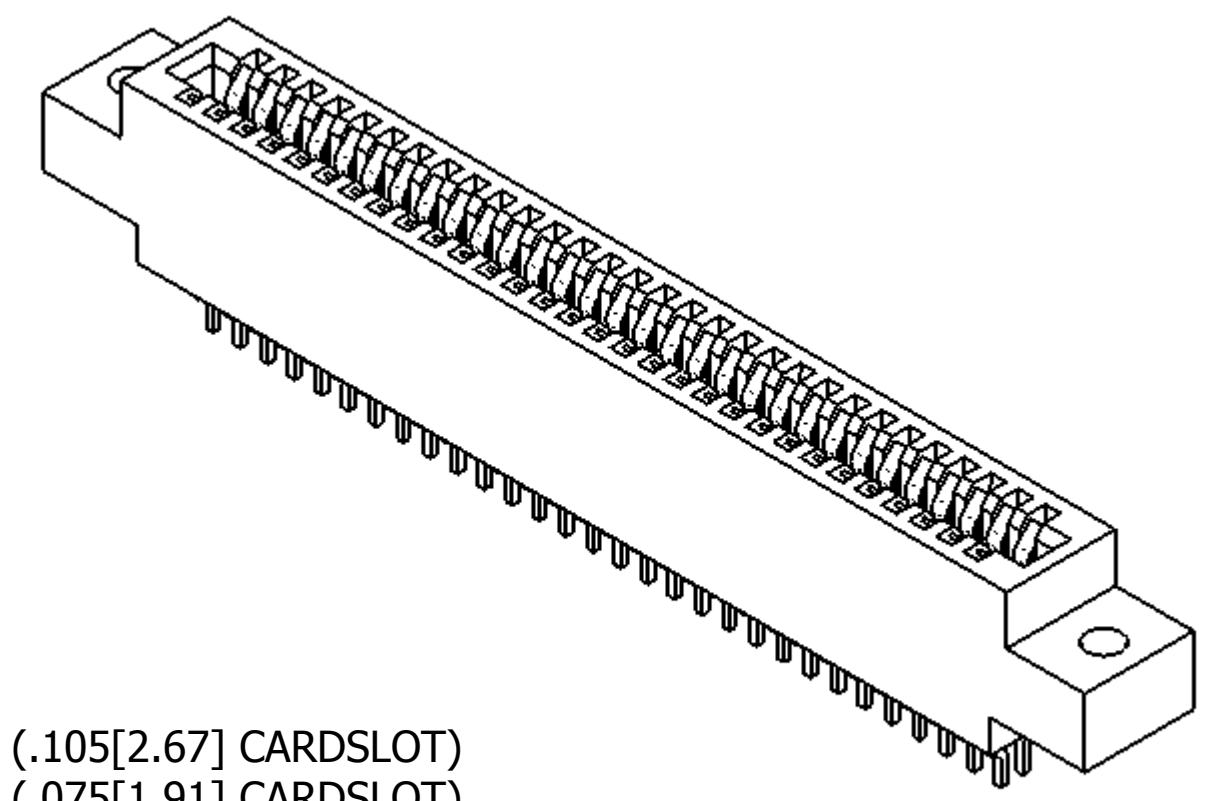

2X  $\phi$ .125 [3.18]  
 S1191 = .093[2.36] PCB (.105[2.67] CARDSLOT)  
 S1243 = .062[1.57] PCB (.075[1.91] CARDSLOT)

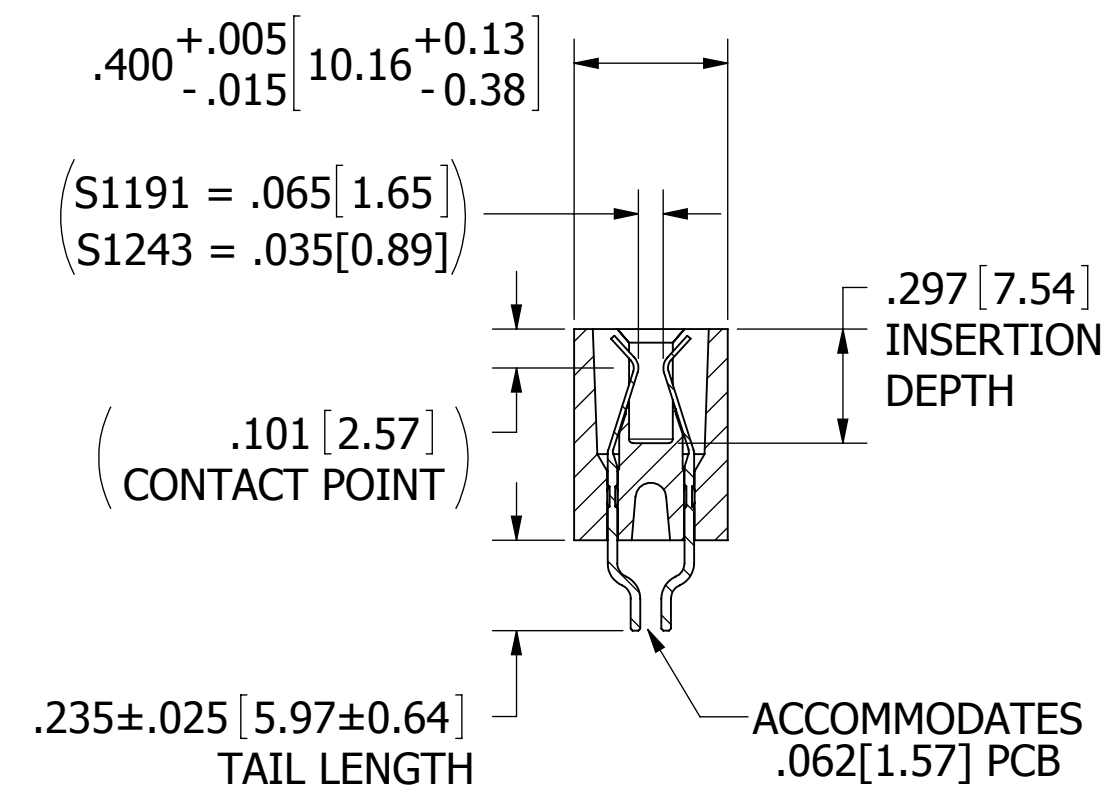

--- C --- DKRH - S1191  
 --- C --- DKRH - S1243

- NOTES:**
- INSULATOR MATERIAL: SEE PART NUMBER CODING.
  - CONTACT MATERIAL: SEE PART NUMBER CODING.
  - PLATING: SEE PART NUMBER CODING.
  - OPERATING TEMPERATURE: SEE PART NUMBER CODING.
  - PROCESSING TEMP: SEE PART NUMBER CODING.
  - UL FLAMMABILITY RATING: 94V-0
  - OPERATING VOLTAGE: 700 VAC MINIMUM AT SEA LEVEL
  - CURRENT RATING: 3 AMP
  - CONTACT RESISTANCE: 30 MILLI OHMS MAX
  - INSULATION RESISTANCE: 5000 MEGA OHMS
  - DURABILITY: 500 CYCLES MIN
  - CONNECTOR IDENTIFICATION: THE PART SHALL BE MARKED WITH A PART NUMBER AND LOT CODE
  - BOARD THICKNESS ACCOMMODATED:  $.062 \pm .008 [1.57 \pm 0.20]$  FOR S1243,  $.093 \pm .008 [2.36 \pm 0.20]$  FOR S1191
  - INSERTION FORCE: 16 OZ MAX PER CONTACT PAIR WHEN USING A .062[1.57] / .093[2.36] TEST BLADE
  - INTERNAL INSPECTION TO BE PER SULLIN'S WORK INSTRUCTION WI7.3-01
  - WITHDRAWAL FORCE: 1 OZ MIN PER CONTACT PAIR USING .062[1.57] / .093[2.36] PCB
  - MODIFICATION: SEE PART NUMBER CODING.



# CUSTOMER COPY

UNLESS OTHERWISE SPECIFIED: DIMENSIONS ARE IN INCHES [MM]		DRAWN	DATE	NAME		
TOLERANCES: ANGULAR: $\pm 1^\circ$ DECIMALS .XX = $\pm .02 [ .5]$ .XXX = $\pm .005 [ .13]$ .XXXX = $\pm .0005 [ .013]$			1/21/14	JH		TITLE EDGECARD, .100 CC, .062 & .093 PCB, HP
THE INFORMATION HEREIN CONTAINS PROPRIETARY INFORMATION OF SULLINS ELECTRONICS AND IS NOT TO BE REPRODUCED, USED OR DISCLOSED TO OTHERS FOR ANY PURPOSE EXCEPT AS SPECIFICALLY AUTHORIZED IN WRITING BY AN OFFICER OF SULLINS ELECTRONICS.		PART NUMBER			--- C --- DKR --- S1191, S1243	
		SIZE	CAGE CODE	DWG. NO.	REV	
		C	54453	C10808	E	
SCALE: 2:1		SHEET 1 OF 3				



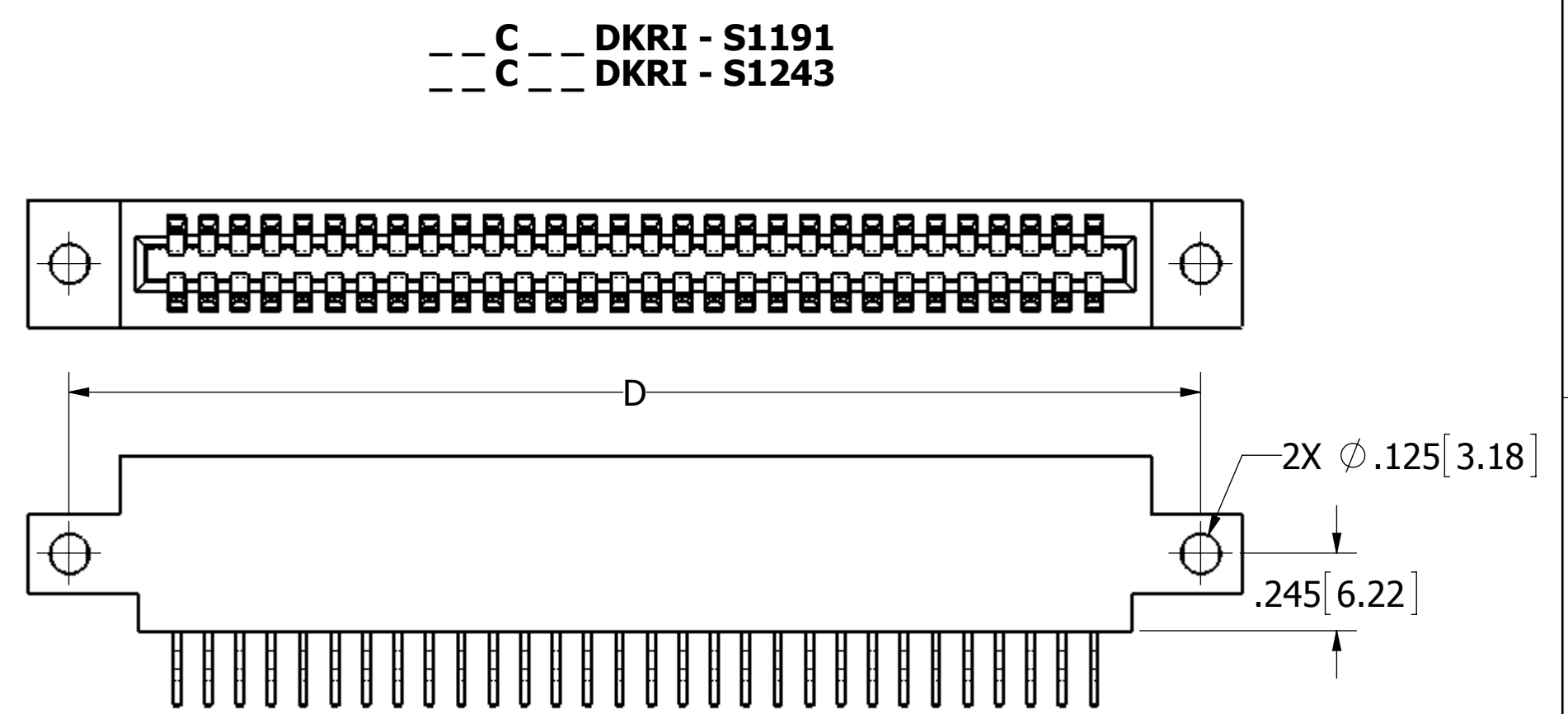
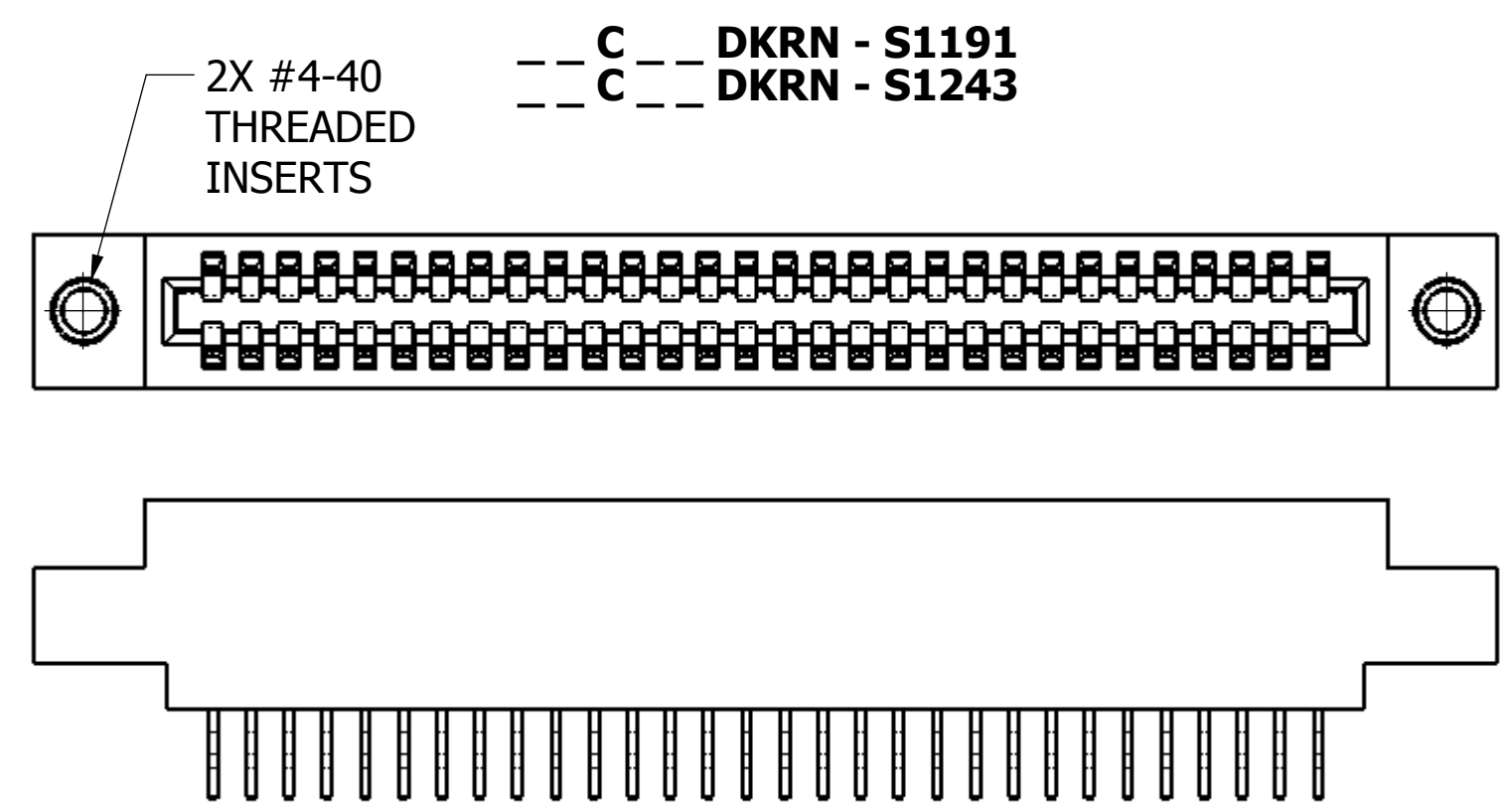
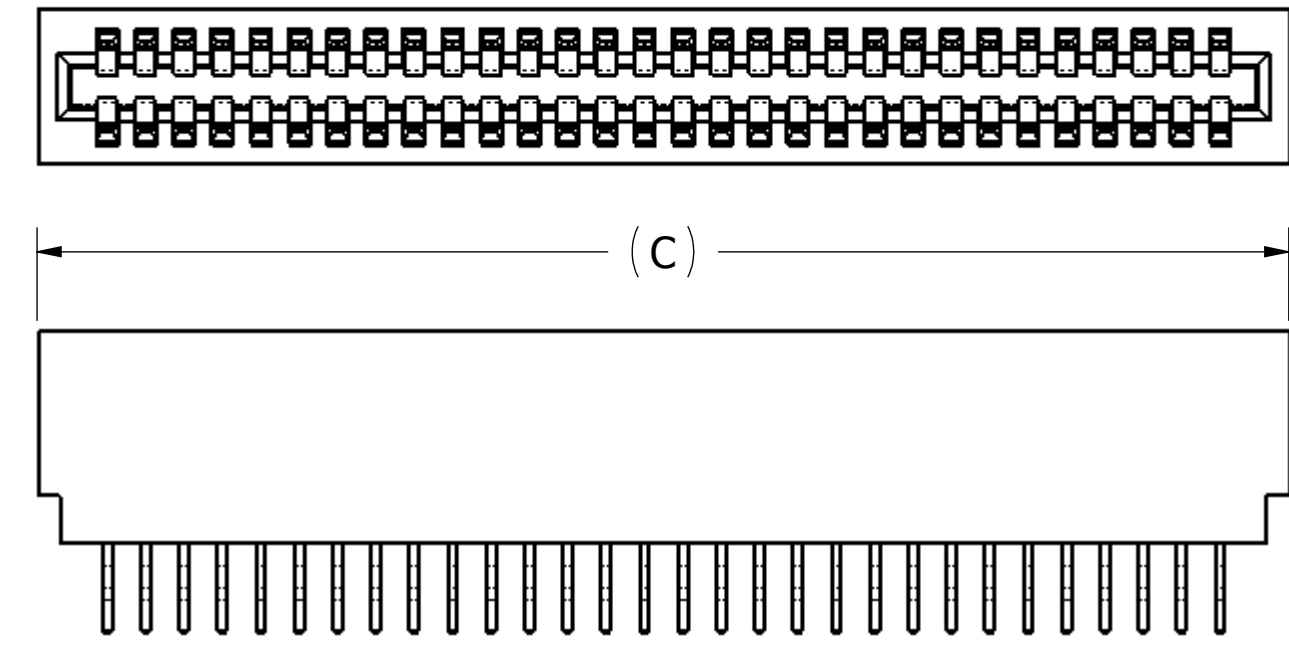
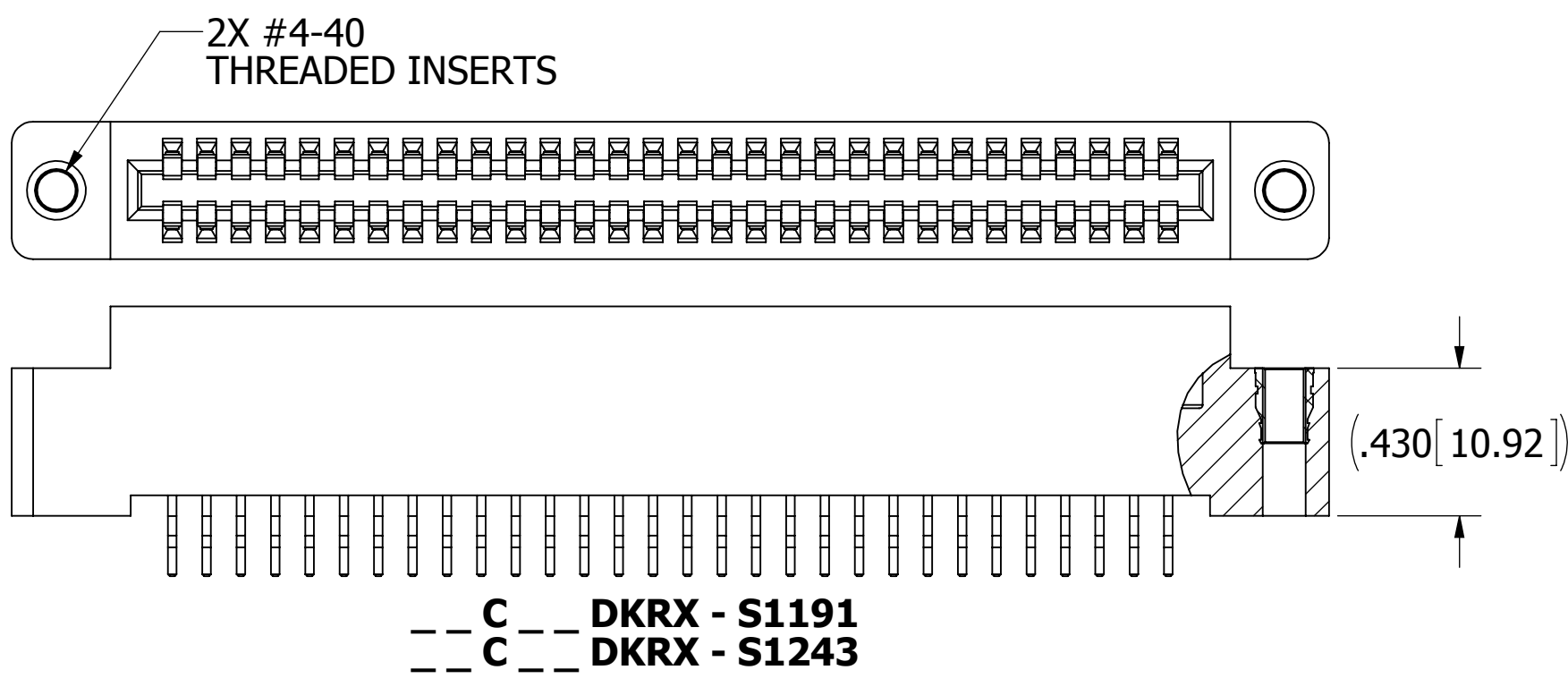
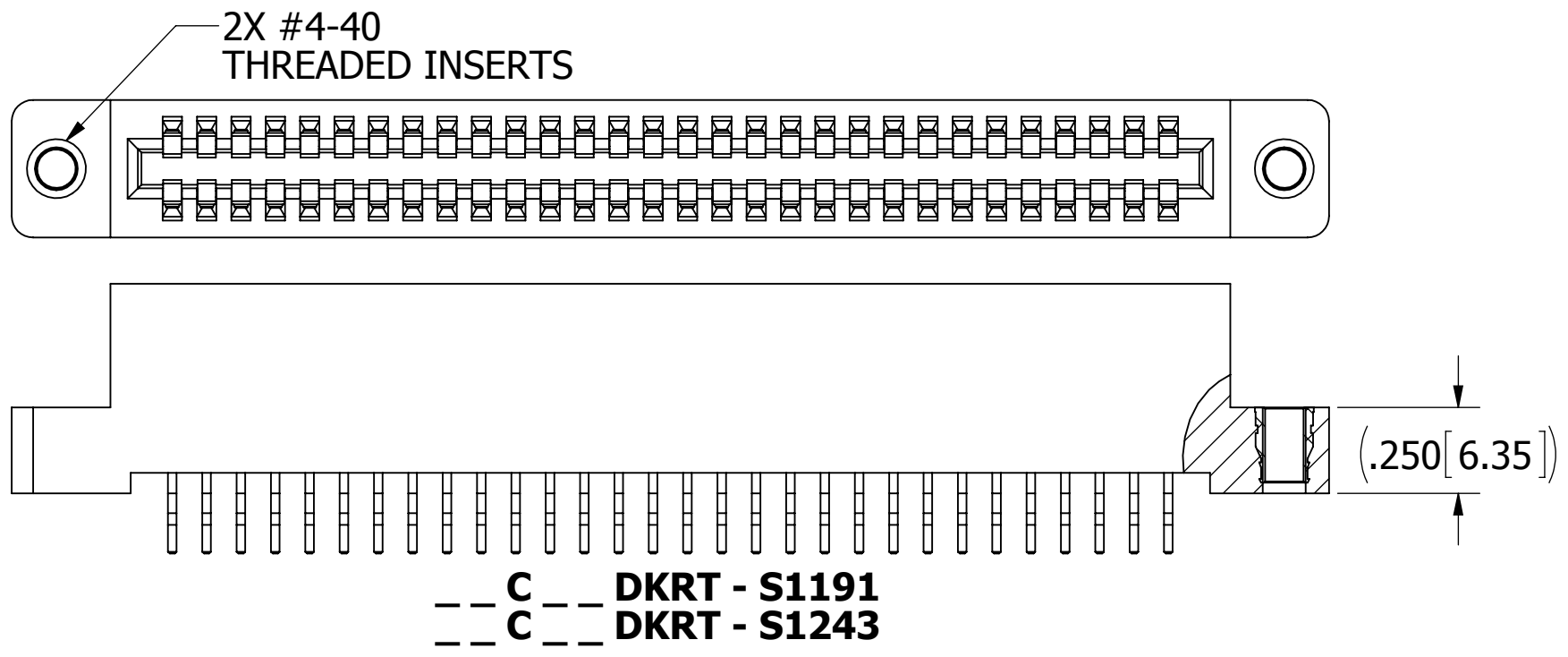
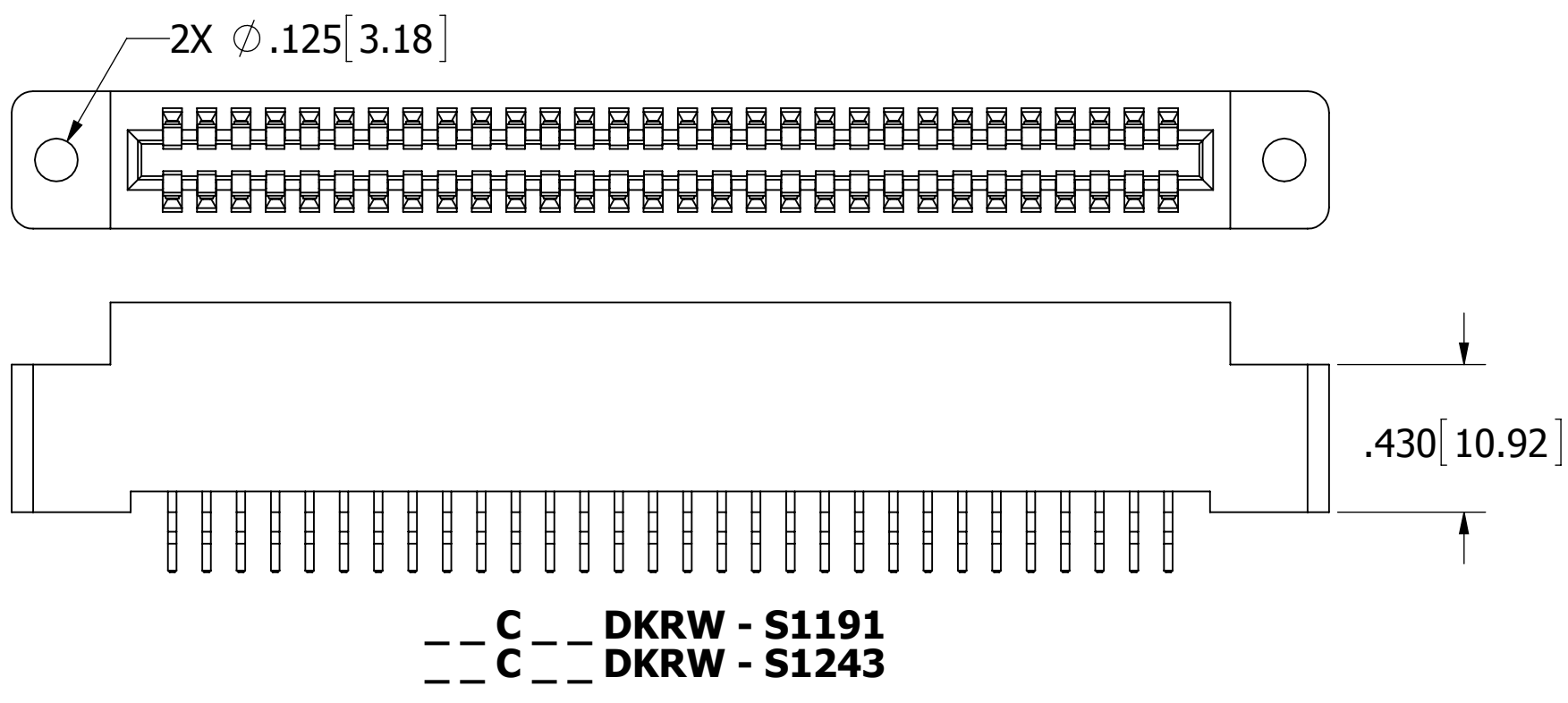
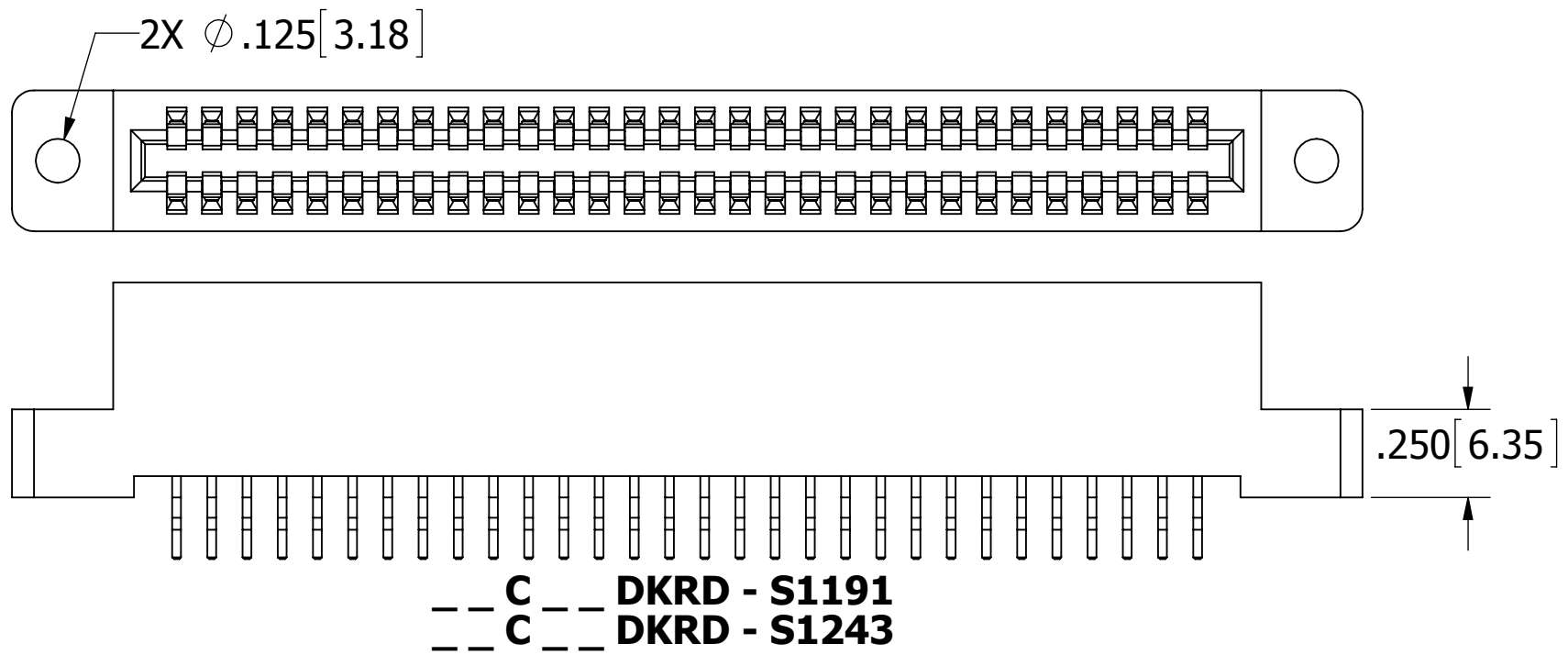

# CUSTOMER COPY



UNLESS OTHERWISE SPECIFIED:  
DIMENSIONS ARE IN INCHES [MM]

TOLERANCES:  
ANGULAR: ± 1°  
DECIMALS  
.XX = ± .02 [.5]  
.XXX = ± .005 [.13]  
.XXXX = ± .0005 [.013]

DRAWN	DATE	NAME
	1/21/14	JH
<small>THE INFORMATION HEREIN CONTAINS PROPRIETARY INFORMATION OF SULLINS ELECTRONICS AND IS NOT TO BE REPRODUCED, USED OR DISCLOSED TO OTHERS FOR ANY PURPOSE EXCEPT AS SPECIFICALLY AUTHORIZED IN WRITING BY AN OFFICER OF SULLINS ELECTRONICS.</small>		
		<small>SCALE: 2:1</small>

TITLE EDGE CARD, .100 CC, .062 & .093 PCB, HP		
PART NUMBER --- C --- DKR --- S1191, S1243		
SIZE	CAGE CODE	DWG. NO.
C	54453	C10808
REV E		SHEET 2 OF 3

PART NUMBER	NO. OF POS.	INCHES					MILLIMETERS						
		A±.008	B±.012	C±.015	D±.010	E±.020	F±.015	A±0.20	B±0.30	C±0.38	D±0.25	E±0.51	F±0.38
C04DKR -S	4	0.300	0.500	0.660	0.975	1.235	0.542	7.62	12.70	16.76	24.77	31.37	13.77
C05DKR -S	5	0.400	0.600	0.760	1.075	1.335	0.642	10.16	15.24	19.30	27.31	33.91	16.31
C06DKR -S	6	0.500	0.700	0.860	1.175	1.435	0.742	12.70	17.78	21.84	29.85	36.45	18.85
C07DKR -S	7	0.600	0.800	0.960	1.275	1.535	0.842	15.24	20.32	24.38	32.39	38.99	21.39
C08DKR -S	8	0.700	0.900	1.060	1.375	1.635	0.942	17.78	22.86	26.92	34.93	41.53	23.93
C09DKR -S	9	0.800	1.000	1.160	1.475	1.735	1.042	20.32	25.40	29.46	37.47	44.07	26.47
C10DKR -S	10	0.900	1.100	1.260	1.575	1.835	1.142	22.86	27.94	32.00	40.01	46.61	29.01
C11DKR -S	11	1.000	1.200	1.360	1.675	1.935	1.242	25.40	30.48	34.54	42.55	49.15	31.55
C12DKR -S	12	1.100	1.300	1.460	1.775	2.035	1.342	27.94	33.02	37.08	45.09	51.69	34.09
C13DKR -S	13	1.200	1.400	1.560	1.875	2.135	1.442	30.48	35.56	39.62	47.63	54.23	36.63
C14DKR -S	14	1.300	1.500	1.660	1.975	2.235	1.542	33.02	38.10	42.16	50.17	56.77	39.17
C15DKR -S	15	1.400	1.600	1.760	2.075	2.335	1.642	35.56	40.64	44.70	52.71	59.31	41.71
C16DKR -S	16	1.500	1.700	1.860	2.175	2.435	1.742	38.10	43.18	47.24	55.25	61.85	44.25
C17DKR -S	17	1.600	1.800	1.960	2.275	2.535	1.842	40.64	45.72	49.78	57.79	64.39	46.79
C18DKR -S	18	1.700	1.900	2.060	2.375	2.635	1.942	43.18	48.26	52.32	60.33	66.93	49.33
C19DKR -S	19	1.800	2.000	2.160	2.475	2.735	2.042	45.72	50.80	54.86	62.87	69.47	51.87
C20DKR -S	20	1.900	2.100	2.260	2.575	2.835	2.142	48.26	53.34	57.40	65.41	72.01	54.41
C21DKR -S	21	2.000	2.200	2.360	2.675	2.935	2.242	50.80	55.88	59.94	67.95	74.55	56.95
C22DKR -S	22	2.100	2.300	2.460	2.775	3.035	2.342	53.34	58.42	62.48	70.49	77.09	59.49
C23DKR -S	23	2.200	2.400	2.560	2.875	3.135	2.442	55.88	60.96	65.02	73.03	79.63	62.03
C24DKR -S	24	2.300	2.500	2.660	2.975	3.235	2.542	58.42	63.50	67.56	75.57	82.17	64.57
C25DKR -S	25	2.400	2.600	2.760	3.075	3.335	2.642	60.96	66.04	70.10	78.11	84.71	67.11
C26DKR -S	26	2.500	2.700	2.860	3.175	3.435	2.742	63.50	68.58	72.64	80.65	87.25	69.65
C27DKR -S	27	2.600	2.800	2.960	3.275	3.535	2.842	66.04	71.12	75.18	83.19	89.79	72.19
C28DKR -S	28	2.700	2.900	3.060	3.375	3.635	2.942	68.58	73.66	77.72	85.73	92.33	74.73
C29DKR -S	29	2.800	3.000	3.160	3.475	3.735	3.042	71.12	76.20	80.26	88.27	94.87	77.27
C30DKR -S	30	2.900	3.100	3.260	3.575	3.835	3.142	73.66	78.74	82.80	90.81	97.41	79.81
C31DKR -S	31	3.000	3.200	3.360	3.675	3.935	3.242	76.20	81.28	85.34	93.35	99.95	82.35
C32DKR -S	32	3.100	3.300	3.460	3.775	4.035	3.342	78.74	83.82	87.88	95.89	102.49	84.89
C33DKR -S	33	3.200	3.400	3.560	3.875	4.135	3.442	81.28	86.36	90.42	98.43	105.03	87.43
C34DKR -S	34	3.300	3.500	3.660	3.975	4.235	3.542	83.82	88.90	92.96	100.97	107.57	89.97
C35DKR -S	35	3.400	3.600	3.760	4.075	4.335	3.642	86.36	91.44	95.50	103.51	110.11	92.51
C36DKR -S	36	3.500	3.700	3.860	4.175	4.435	3.742	88.90	93.98	98.04	106.05	112.65	95.05
C37DKR -S	37	3.600	3.800	3.960	4.275	4.535	3.842	91.44	96.52	100.58	108.59	115.19	97.59
C38DKR -S	38	3.700	3.900	4.060	4.375	4.635	3.942	93.98	99.06	103.12	111.13	117.73	100.13
C39DKR -S	39	3.800	4.000	4.160	4.475	4.735	4.042	96.52	101.60	105.66	113.67	120.27	102.67
C40DKR -S	40	3.900	4.100	4.260	4.575	4.835	4.142	99.06	104.14	108.20	116.21	122.81	105.21
C41DKR -S	41	4.000	4.200	4.360	4.675	4.935	4.242	101.60	106.68	110.74	118.75	125.35	107.75
C42DKR -S	42	4.100	4.300	4.460	4.775	5.035	4.342	104.14	109.22	113.28	121.29	127.89	110.29
C43DKR -S	43	4.200	4.400	4.560	4.875	5.135	4.442	106.68	111.76	115.82	123.83	130.43	112.83
C44DKR -S	44	4.300	4.500	4.660	4.975	5.235	4.542	109.22	114.30	118.36	126.37	132.97	115.37
C45DKR -S	45	4.400	4.600	4.760	5.075	5.335	4.642	111.76	116.84	120.90	128.91	135.51	117.91
C46DKR -S	46	4.500	4.700	4.860	5.175	5.435	4.742	114.30	119.38	123.44	131.45	138.05	120.45
C47DKR -S	47	4.600	4.800	4.960	5.275	5.535	4.842	116.84	121.92	125.98	133.99	140.59	122.99
C48DKR -S	48	4.700	4.900	5.060	5.375	5.635	4.942	119.38	124.46	128.52	136.53	143.13	125.53
C49DKR -S	49	4.800	5.000	5.160	5.475	5.735	5.042	121.92	127.00	131.06	139.07	145.67	128.07
C50DKR -S	50	4.900	5.100	5.260	5.575	5.835	5.142	124.46	129.54	133.60	141.61	148.21	130.61
C51DKR -S	51	5.000	5.200	5.360	5.675	5.935	5.242	127.00	132.08	136.14	144.15	150.75	133.15
C52DKR -S	52	5.100	5.300	5.460	5.775	6.035	5.342	129.54	134.62	138.68	146.69	153.29	135.69
C53DKR -S	53	5.200	5.400	5.560	5.875	6.135	5.442	132.08	137.16	141.22	149.23	155.83	138.23
C54DKR -S	54	5.300	5.500	5.660	5.975	6.235	5.542	134.62	139.70	143.76	151.77	158.37	140.77
C55DKR -S	55	5.400	5.600	5.760	6.075	6.335	5.642	137.16	142.24	146.30	154.31	160.91	143.31
C56DKR -S	56	5.500	5.700	5.860	6.175	6.435	5.742	139.70	144.78	148.84	156.85	163.45	145.85
C57DKR -S	57	5.600	5.800	5.960	6.275	6.535	5.842	142.24	147.32	151.38	159.39	165.99	148.39
C58DKR -S	58	5.700	5.900	6.060	6.375	6.635	5.942	144.78	149.86	153.92	161.93	168.53	150.93
C59DKR -S	59	5.800	6.000	6.160	6.475	6.735	6.042	147.32	152.40	156.46	164.47	171.07	153.47
C60DKR -S	60	5.900	6.100	6.260	6.575	6.835	6.142	149.86	154.94	159.00	167.01	173.61	156.01
C61DKR -S	61	6.000	6.200	6.360	6.675	6.935	6.242	152.40	157.48	161.54	169.55	176.15	158.55
C62DKR -S	62	6.100	6.300	6.460	6.775	7.035	6.342	154.94	160.02	164.08	172.09	178.69	161.09
C63DKR -S	63	6.200	6.400	6.560	6.875	7.135	6.442	157.48	162.56	166.62	174.63	181.23	163.63
C64DKR -S	64	6.300	6.500	6.660	6.975	7.235	6.542	160.02	165.10	169.16	177.17	183.77	166.17
C65DKR -S	65	6.400	6.600	6.760	7.075	7.335	6.642	162.56	167.64	171.70	179.71	186.31	168.71
C66DKR -S	66	6.500	6.700	6.860	7.175	7.435	6.742	165.10	170.18	174.24	182.25	188.85	171.25
C67DKR -S	67	6.600	6.800	6.960	7.275	7.535	6.842	167.64	172.72	176.78	184.79	191.39	173.79
C68DKR -S	68	6.700	6.900	7.060	7.375	7.635	6.942	170.18	175.26	179.32	187.33	193.93	176.33
C69DKR -S	69	6.800	7.000	7.160	7.475	7.735	7.042	172.72	177.80	181.86	189.87	196.47	178.87
C70DKR -S	70	6.900	7.100	7.260	7.575	7.835	7.142	175.26	180.34	184.40	192.41	199.01	181.41

# CUSTOMER COPY



UNLESS OTHERWISE SPECIFIED: DIMENSIONS ARE IN INCHES (MM)		DRAWN	DATE	NAME	
			1/21/14	JH	
TOLERANCES: ANGULAR: ± 1° DECIMALS .XX=± .02 [.5] .XXX=± .005 [.13] .XXXX=± .0005 [.013]					THE INFORMATION HEREIN CONTAINS PROPRIETARY INFORMATION OF SULLINS ELECTRONICS AND IS NOT TO BE REPRODUCED, USED OR DISCLOSED TO OTHERS FOR ANY PURPOSE EXCEPT AS SPECIFICALLY AUTHORIZED IN WRITING BY AN OFFICER OF SULLINS ELECTRONICS.
TITLE EDGECARD, .100 CC, .062 & .093 PCB, HP					
PART NUMBER C DKR -S1191, S1243					
SIZE	CAGE CODE	DWG. NO.	REV		
C	54453	C10808	E		
SCALE: 2:1		SHEET 3 OF 3			