



Chipsmall Limited consists of a professional team with an average of over 10 year of expertise in the distribution of electronic components. Based in Hongkong, we have already established firm and mutual-benefit business relationships with customers from,Europe,America and south Asia,supplying obsolete and hard-to-find components to meet their specific needs.

With the principle of “Quality Parts,Customers Priority,Honest Operation,and Considerate Service”,our business mainly focus on the distribution of electronic components. Line cards we deal with include Microchip,ALPS,ROHM,Xilinx,Pulse,ON,Everlight and Freescale. Main products comprise IC,Modules,Potentiometer,IC Socket,Relay,Connector.Our parts cover such applications as commercial,industrial, and automotives areas.

We are looking forward to setting up business relationship with you and hope to provide you with the best service and solution. Let us make a better world for our industry!



Contact us

Tel: +86-755-8981 8866 Fax: +86-755-8427 6832

Email & Skype: info@chipsmall.com Web: www.chipsmall.com

Address: A1208, Overseas Decoration Building, #122 Zhenhua RD., Futian, Shenzhen, China



Features

- 0.4 inch digit height.
- Low current operation.
- Excellent character appearance.
- Mechanically rugged.
- Gray face,white segment.
- Package: 250pcs/ reel.
- Moisture sensitivity level : level 2a.
- RoHS compliant.

Description

The Hyper Red source color devices are made with Al-GaN on GaAs substrate Light Emitting Diode.

Package Dimensions& Internal Circuit Diagram

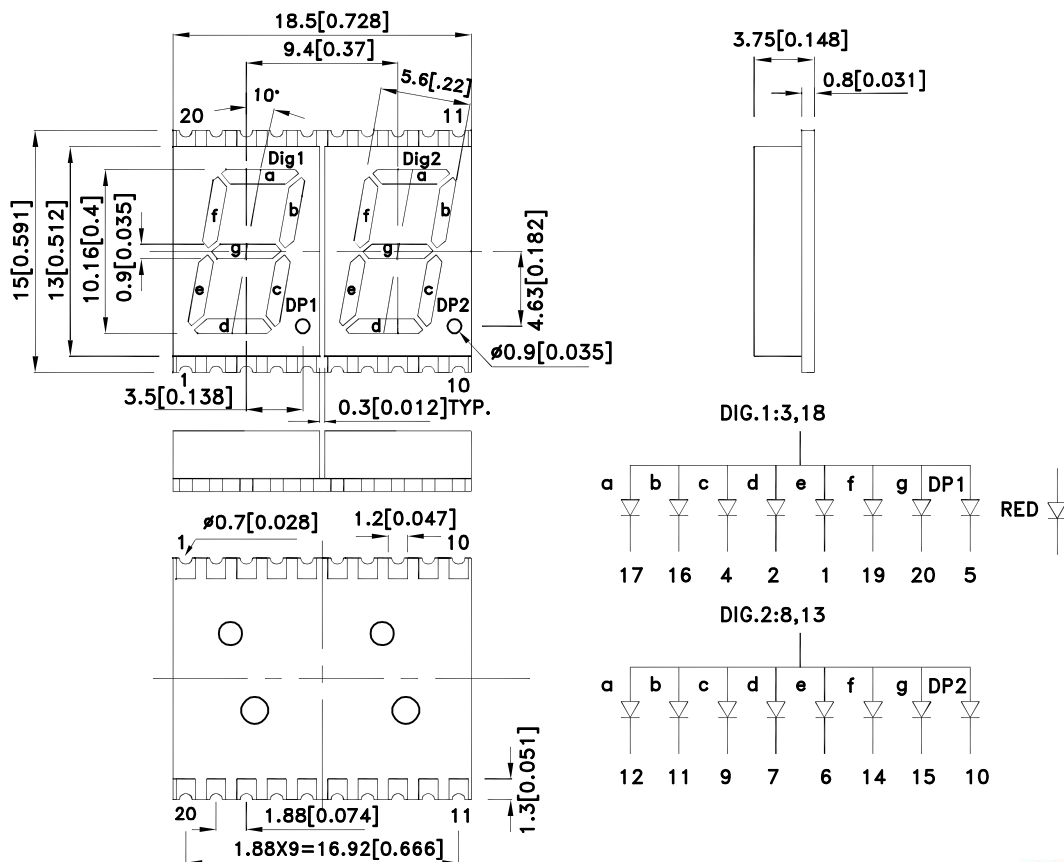

Notes:

1. All dimensions are in millimeters (inches), Tolerance is $\pm 0.25(0.01)$ unless otherwise noted.
2. The specifications, characteristics and technical data described in the datasheet are subject to change without prior notice.
3. The gap between the reflector and PCB shall not exceed 0.25mm.



Selection Guide

Part No.	Dice	Lens Type	Iv (ucd) [1] @ 10mA		Description
			Min.	Typ.	
ACDA04-41SURKWA-F01	Hyper Red (AlGaInP)	White Diffused	14000	27000	Common Anode, Rt. Hand Decimal.

Note:

1. Luminous intensity/ luminous Flux: +/-15%.

Electrical / Optical Characteristics at TA=25°C

Symbol	Parameter	Device	Typ.	Max.	Units	Test Conditions
λ_{peak}	Peak Wavelength	Hyper Red	650		nm	I _F =20mA
λ_D [1]	Dominant Wavelength	Hyper Red	630		nm	I _F =20mA
$\Delta\lambda_{1/2}$	Spectral Line Half-width	Hyper Red	28		nm	I _F =20mA
C	Capacitance	Hyper Red	35		pF	V _F =0V;f=1MHz
V _F [2]	Forward Voltage	Hyper Red	1.95	2.5	V	I _F =20mA
I _R	Reverse Current	Hyper Red		10	uA	V _R =5V

Notes:

1. Wavelength: +/-1nm.

2. Forward Voltage: +/-0.1V.

Absolute Maximum Ratings at TA=25°C

Parameter	Hyper Red	Units
Power dissipation	75	mW
DC Forward Current	30	mA
Peak Forward Current [1]	185	mA
Reverse Voltage	5	V
Operating / Storage Temperature	-40°C To +85°C	

Note:

1. 1/10 Duty Cycle, 0.1ms Pulse Width.

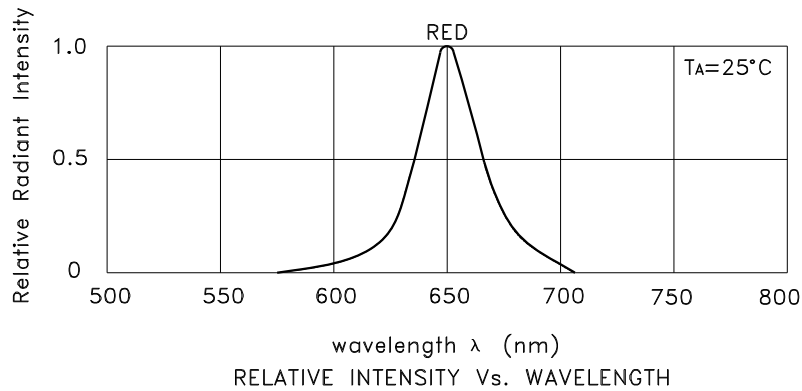

Hyper Red

ACDA04-41SURKWA-F01

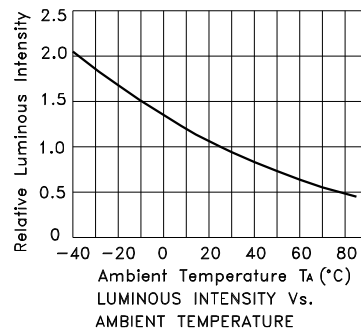
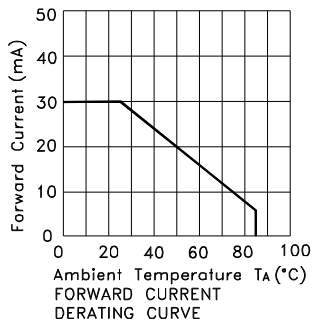
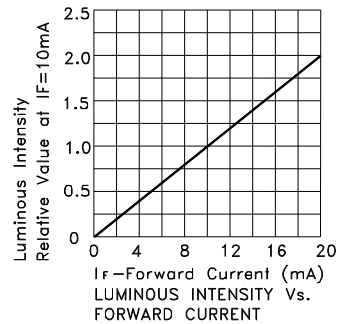
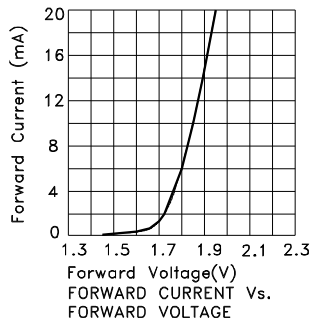

CIRCUIT DESIGN NOTES

1. Protective current-limiting resistors may be necessary to operate the Displays.
2. LEDs mounted in parallel should each be placed in series with its own current-limiting resistor.

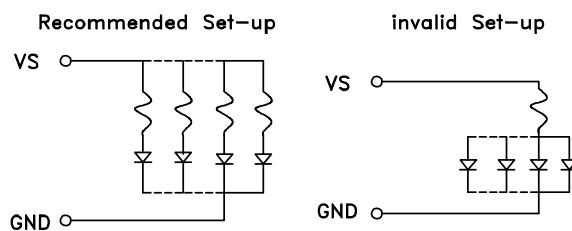

ACDA04-41SURKWA-F01

Reflow Soldering Profile For Lead-free SMT Process.

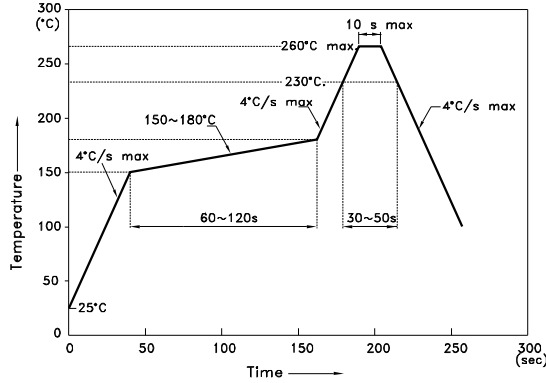

NOTES:

1. We recommend the reflow temperature 245°C (+/-5°C). The maximum soldering temperature should be limited to 260°C.
2. Don't cause stress to the epoxy resin while it is exposed to high temperature.
3. Number of reflow process shall be 2 times or less.

Recommended Soldering Pattern (Units : mm; Tolerance: ± 0.15)

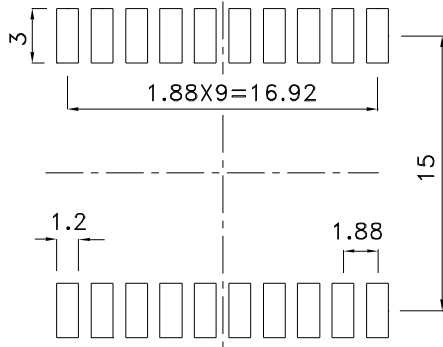

Reel Dimension

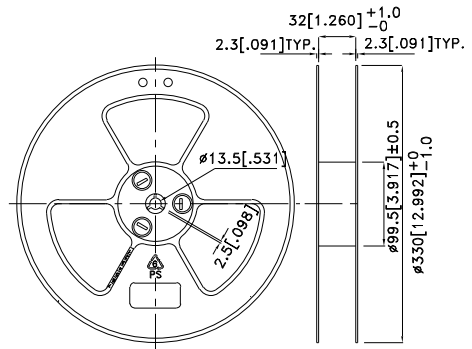

Tape Specifications (Units : mm)

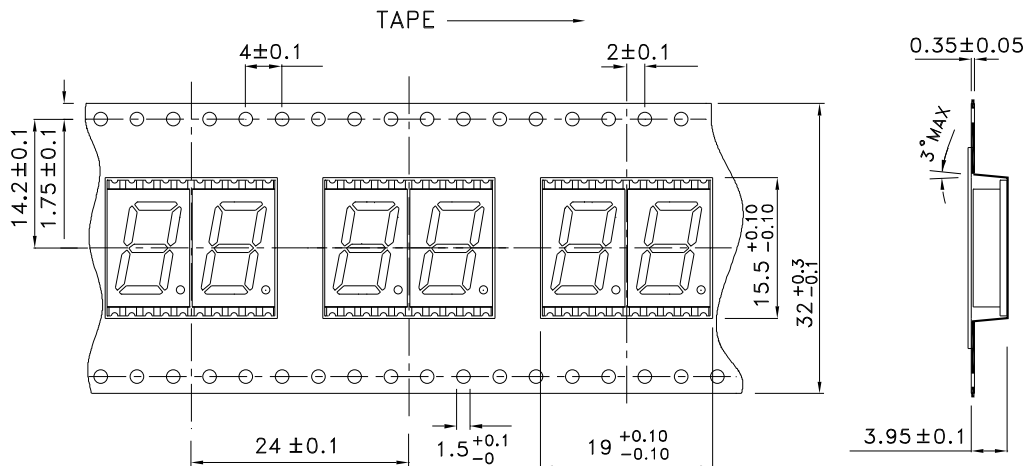

PACKING & LABEL SPECIFICATIONS

ACDA04-41SURKWA-F01

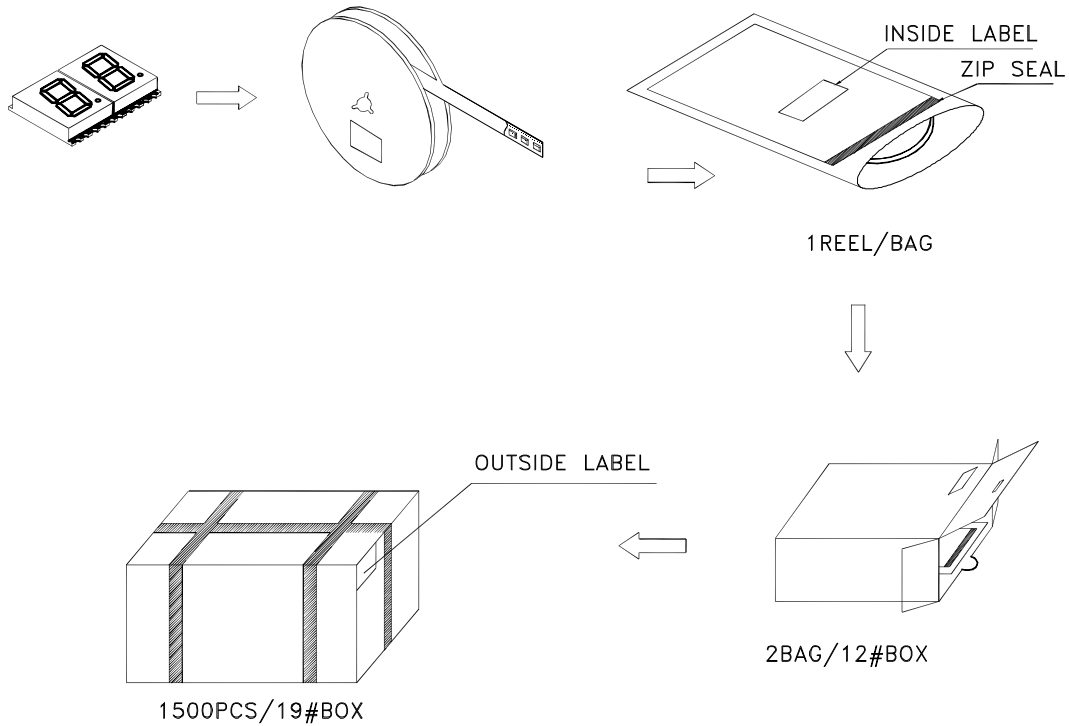

Inside Label On Tape

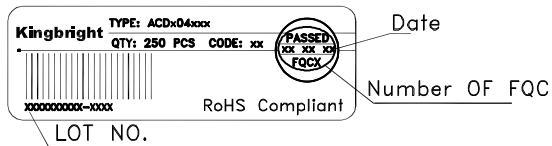

Outside Label On Bag

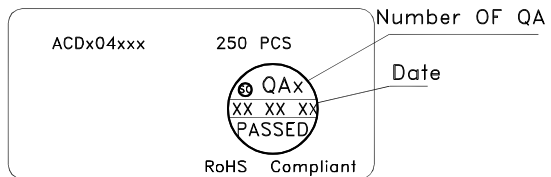

Outside Label On 19#Box

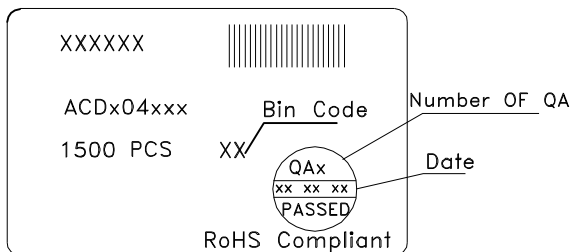

Outside Label On 12#Box

