



Chipsmall Limited consists of a professional team with an average of over 10 year of expertise in the distribution of electronic components. Based in Hongkong, we have already established firm and mutual-benefit business relationships with customers from,Europe,America and south Asia,supplying obsolete and hard-to-find components to meet their specific needs.

With the principle of “Quality Parts,Customers Priority,Honest Operation,and Considerate Service”,our business mainly focus on the distribution of electronic components. Line cards we deal with include Microchip,ALPS,ROHM,Xilinx,Pulse,ON,Everlight and Freescale. Main products comprise IC,Modules,Potentiometer,IC Socket,Relay,Connector.Our parts cover such applications as commercial,industrial, and automotives areas.

We are looking forward to setting up business relationship with you and hope to provide you with the best service and solution. Let us make a better world for our industry!



Contact us

Tel: +86-755-8981 8866 Fax: +86-755-8427 6832

Email & Skype: info@chipsmall.com Web: www.chipsmall.com

Address: A1208, Overseas Decoration Building, #122 Zhenhua RD., Futian, Shenzhen, China



ACFF-1024

ISM Bandpass Filter (2401 – 2482 MHz)



Data Sheet

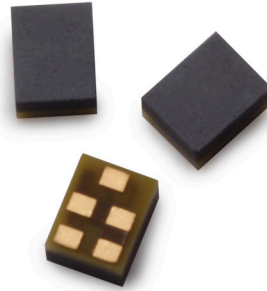

Description

The Avago ACFF-1024 is a miniaturized Bandpass Filter designed for use in the 2.4 GHz Industrial, Scientific and Medical (ISM) band.

The ACFF-1024 is designed to enable concurrent operation of Wireless LAN and Bluetooth applications that coexist with other wireless standards, such as 2.5 GHz WiMAX, PCS, and LTE Bands 7 and 40, without performance degradations due to interference.

The ACFF-1024 is designed with Avago Technologies' innovative Film Bulk Acoustic Resonator (FBAR) technology, which makes possible ultra-small, high-Q filters at a fraction of their usual size.

The ACFF-1024 also utilizes Avago Technologies' advanced Microcap bonded-wafer technology. This chip scale miniaturization process results in a package size of only 1.4 x 1.1 mm and maximum height of 0.80 mm.

The ACFF-1024 is compatible with high volume, lead-free SMT soldering processes and can be direct surface mounted to a PCB or a transfer molded module.

Functional Block Diagram

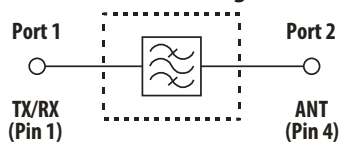

Features

- 50 Ω Input/Output
- No external matching required
- Low Insertion Loss, High Interference Rejection
 - Enables concurrent use of other 2.5 GHz Bands
- Subminiature Size
 - 1.1 x 1.4 mm Footprint
 - 0.80 mm Max Height
- High Power Rating
 - +27 dBm Abs Max Input Power
- Operating Temperature Range
 - -40 °C to +85 °C
- Environmental
 - RoHS 6 Compliant
 - Halogen free
 - TBBPA Free

Specifications

- Performance guaranteed -30 °C to +85 °C
- Low Insertion Loss
- High Interferer Rejection

Applications

802.11 b/g/n WLAN Access Point and Small Cell BTS with embedded WLAN functionality

ACFF-1024 Electrical Specifications ^[2], $Z_0 = 50 \Omega$, T_c ^[1]

Symbol	Parameter	Units	-30 °C to +85 °C		-40 °C	
			Min	Typ ^[3]	Max	Typ
S21	Insertion Loss ^[4]	dB				
	2402.5 – 2421.5 MHz (Wi-Fi Ch 1)			1.6	2.6	1.8
	2407.5 – 2426.5 MHz (Wi-Fi Ch 2)			1.4	2.2	1.6
	2412.5 – 2471.5 MHz (Wi-Fi Ch 3 – 11)			1.3	2.0	1.3
	2457.5 – 2476.5 MHz (Wi-Fi Ch 12)			1.5	2.1	1.5
	2462.5 – 2481.5 MHz (Wi-Fi Ch 13)		1.7	3.0	1.6	
ΔS_{21}	Amplitude Ripple (p-p) ^[4] , +25 °C	dB				
	2402.5 – 2421.5 MHz (Wi-Fi Ch 1)			1.0		1.4
	2407.5 – 2426.5 MHz (Wi-Fi Ch 2)			0.8		1.1
	2412.5 – 2471.5 MHz (Wi-Fi Ch 3 – 11)			0.7		0.9
	2457.5 – 2476.5 MHz (Wi-Fi Ch 12)			0.6		0.7
	2462.5 – 2481.5 MHz (Wi-Fi Ch 13)		1.0		0.9	
S21	Attenuation, 800 – 2300 MHz	dB	45	54		54
S21	Attenuation ^[5] in LTE Band 40, 2300 – 2365 MHz	dB	50	53		52
S21	Attenuation ^[5] in LTE Band 40, 2365 – 2370 MHz	dB				58
	-40 °C					
	-30 °C to +25 °C		50	58		
	+25 °C to +55 °C		43	58		
	+55 °C to +85 °C		30	53		
S21	Attenuation ^[5] in LTE Band 7 (WiMAX), 2500 – 2505 MHz	dB				64
	-40 °C					
	-30 °C to -10 °C		42	56		
	-10 °C to +25 °C		52	59		
	+25 °C to +85 °C		55	64		
S21	Attenuation ^[5] in LTE Band 7 (WiMAX), 2505 – 2690 MHz	dB	57	67		68
S21	Attenuation ^[5] in LTE Band 38, 2570 – 2620 MHz	dB	55	68		68
S21	Attenuation, 2690 – 7500 MHz	dB	40	55		55
2H	2nd Harmonic Level, CW Tone, 2442 MHz, 22.5 dBm at Port 1	dBc	57	67		
S11, S22	Return Loss (SWR), 2402.5 – 2481.5 MHz, +25 °C	dB	9	16 (1.4)	(2.1)	16 (1.4)

Notes:

- T_c is the case temperature and is defined as the temperature of the underside of the Filter where it makes contact with the circuit board.
- Min/Max specifications are guaranteed at the indicated temperature, unless otherwise noted.
- Unless otherwise noted, Typical data is the average value (arithmetic mean) of the parameter over the indicated band at 25 °C.
- Channel average Insertion Loss, which is obtained by averaging $|S_{21}|$ over the center 19 MHz of channels and converting to dB value.
- Channel average Insertion Loss, which is obtained by averaging $|S_{21}|$ over 5 MHz channels and converting to dB value.

Absolute Maximum Ratings ^[1]

Parameter	Unit	Value
Storage temperature	°C	-40 to +125
Maximum RF Input Power to Pin 1 (Port 1, Tx/Rx) ^[4]	dBm	+27

Maximum Recommended Operating Conditions ^[2]

Parameter	Unit	Value
Operating temperature, T_c ^[3]	°C	-40 to +85

Notes:

- Operation in excess of any one of these conditions may result in permanent damage to the device.
- The device will function over the recommended range without degradation in reliability or permanent change in performance, but is not guaranteed to meet electrical specifications.
- T_c is defined as case temperature, the temperature of the underside of the Filter where it makes contact with the circuit board.
- The ACFF-1024 is not symmetrical. Port 1 (Pin 1) is designed for higher power handling and is connected to the Tx/Rx blocks; Port 2 (Pin 4) is connected to the system antenna.

ACFF-1024 Typical Performance at $T_c = 25^\circ\text{C}$

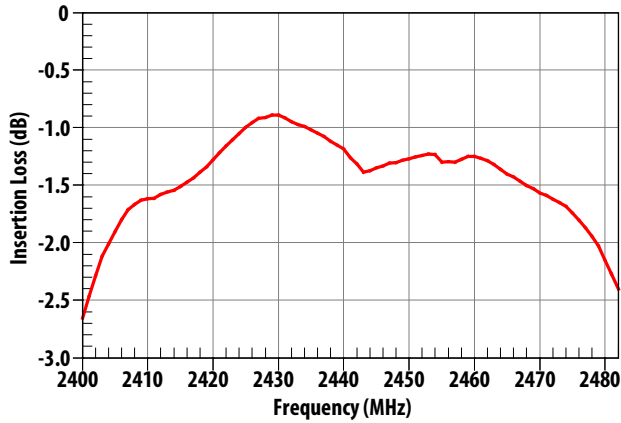

Figure 1. Insertion Loss, 2400 – 2482 MHz

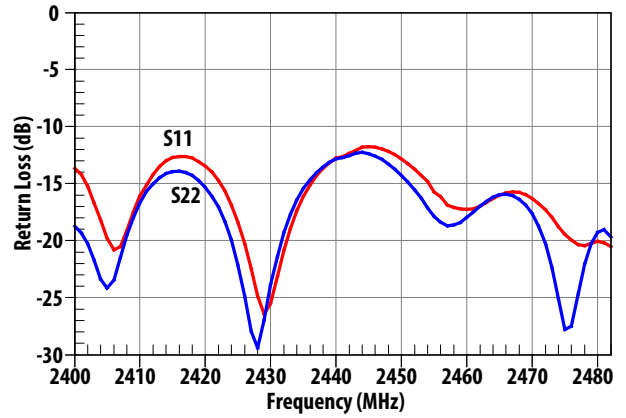

Figure 2. Input, Output Port Return Loss, 2400 – 2482 MHz

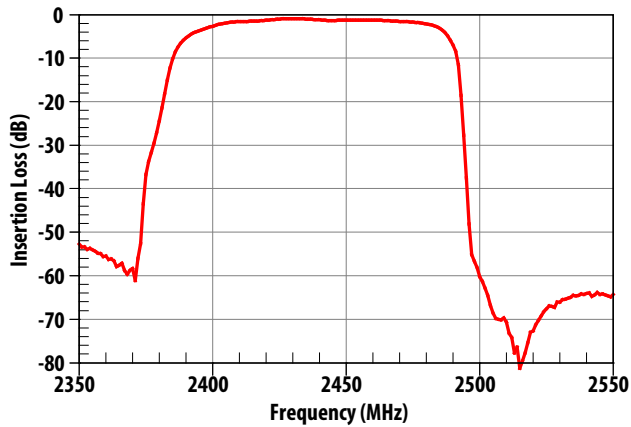

Figure 3. Attenuation, 2350 – 2550 MHz

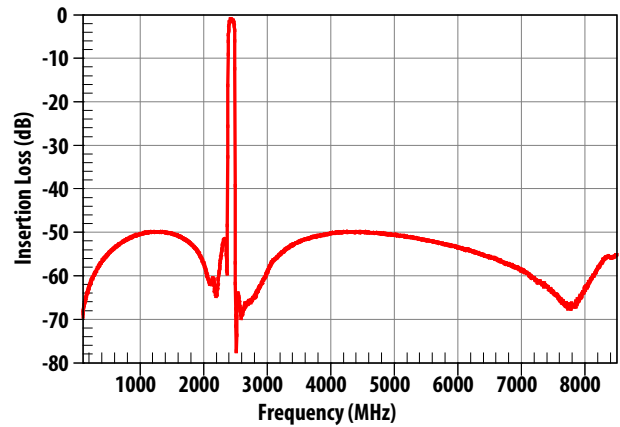

Figure 4. Wideband Attenuation, 100 – 8000 MHz

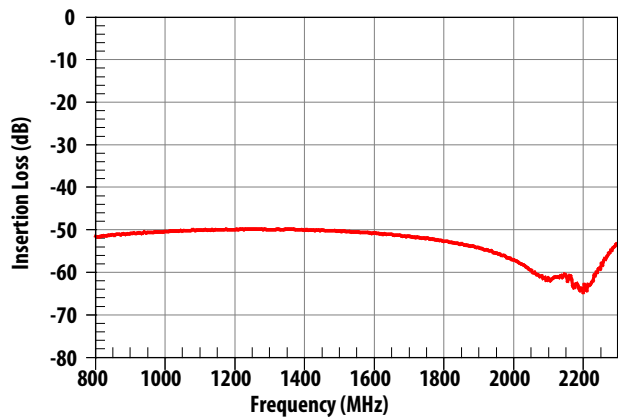

Figure 5. Attenuation, 800 – 2300 MHz

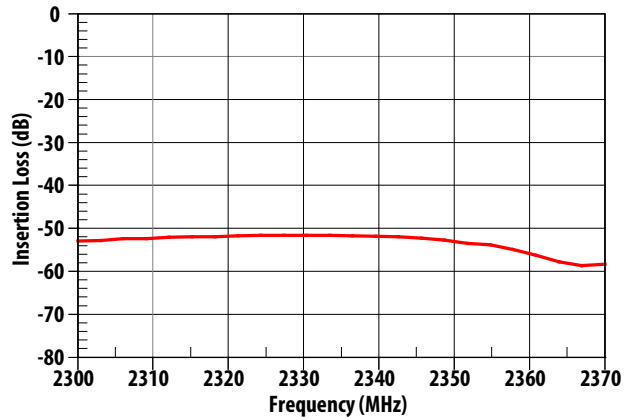

Figure 6. Rejection in LTE Band 40 (2300 – 2370 MHz)

ACFF-1024 Typical Performance at Tc = 25 °C

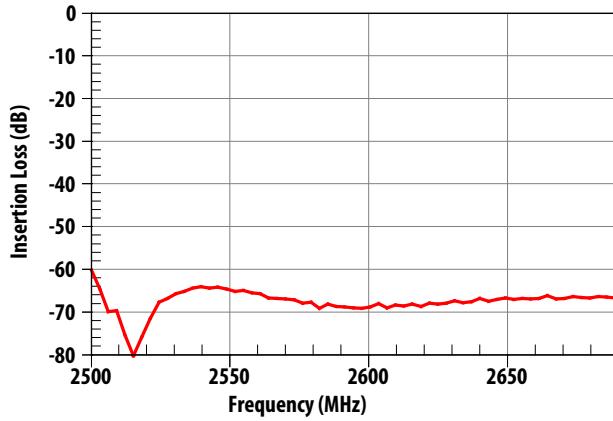

Figure 7. Rejection in 2.5 GHz WiMAX and LTE Band 7 (2500 – 2690 MHz)

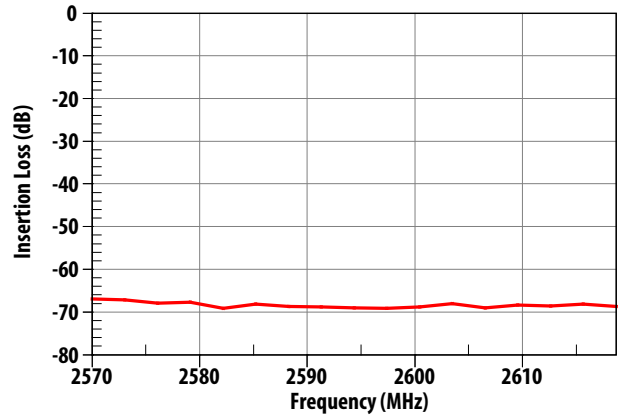

Figure 8. Rejection in LTE Band 38 (2570 – 2620 MHz)

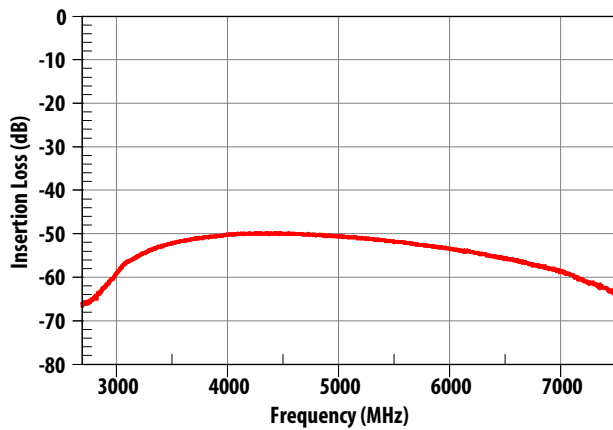

Figure 9. Attenuation, 2690 – 7500 MHz

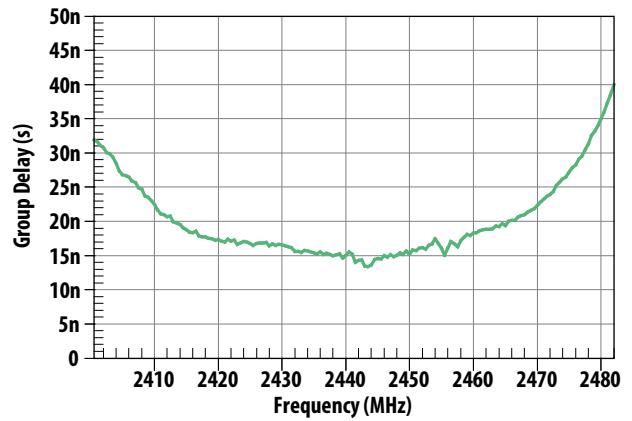

Figure 10. Group Delay (ns), 2400 – 2482 MHz

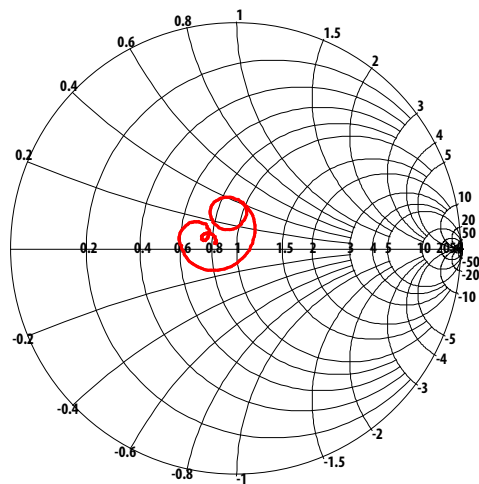

Figure 11. Input Port Impedance, 2400 – 2482 MHz

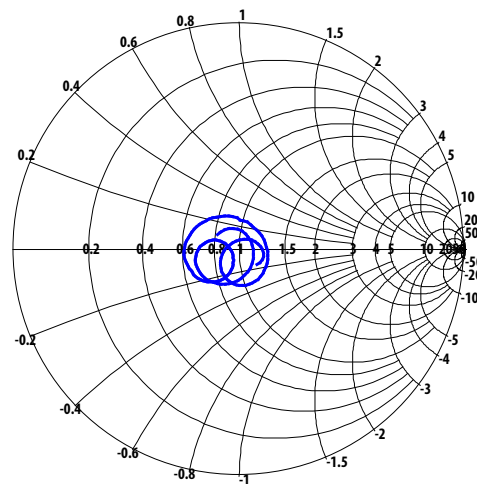

Figure 12. Output Port Impedance, , 2400 – 2482 MHz

ACFF-1024 Performance at Low Temperature

Typical performance of the ACFF-1024 at low temperature is shown in Figure 13 and Figure 14 for $T_c = 25^\circ\text{C}$ and -40°C .

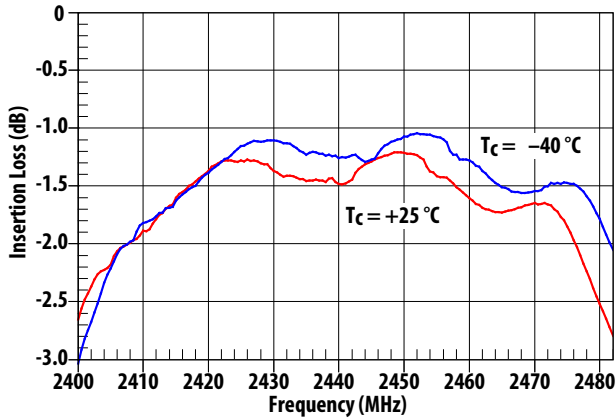

Figure 13. Insertion Loss, 2400 – 2482 MHz, $+25^\circ\text{C}$ and -40°C

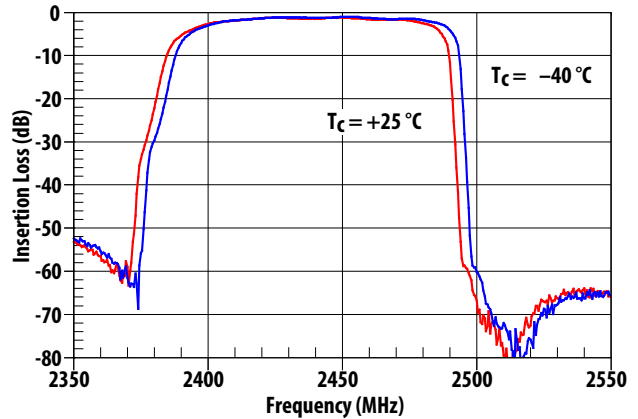

Figure 14. Attenuation, 2350 – 2550 MHz, $+25^\circ\text{C}$ and -40°C

Note: These data are measured on units different from those in previous performance graphs.

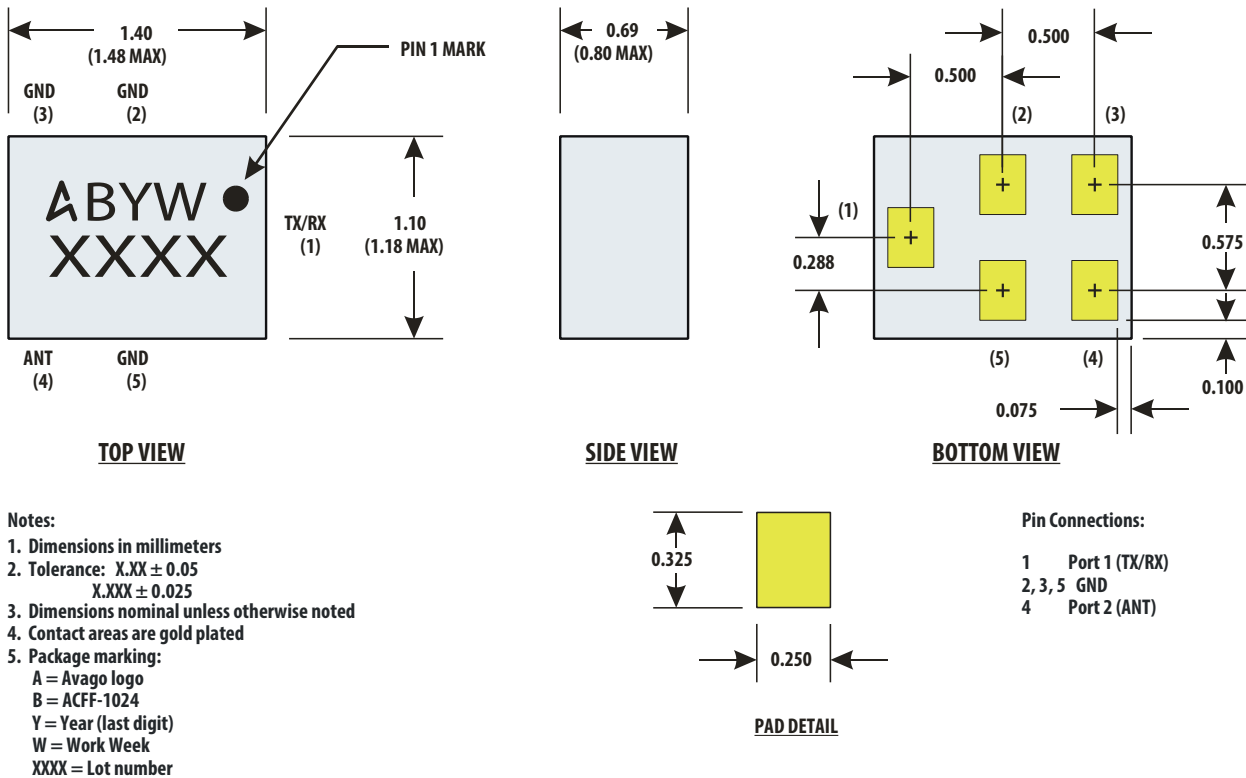

Figure 15. Package Outline Drawing and Marking

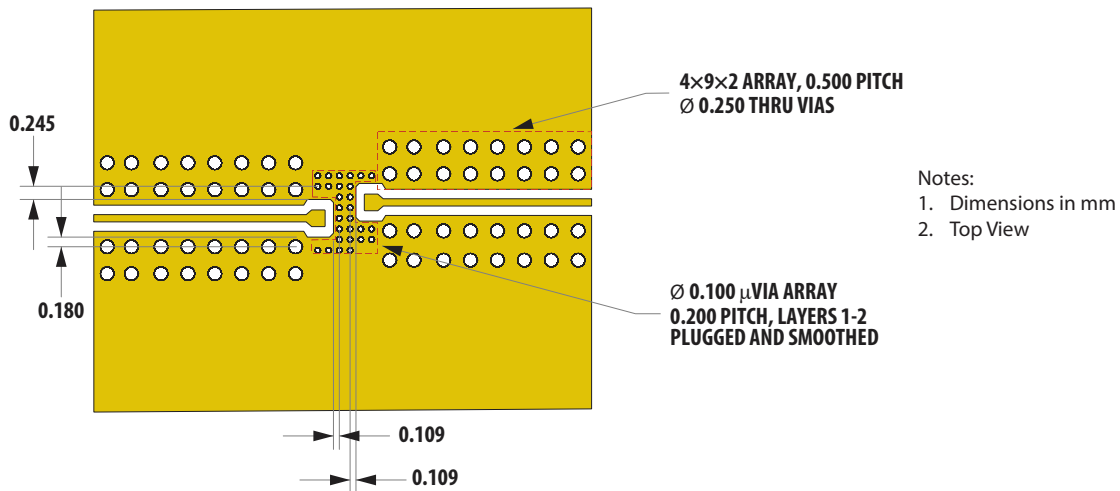

Figure 16. PCB Layout

A circuit board layout using the principles illustrated in Figure 16 is recommended to optimize performance of the ACFF-1024.

Note: The ACFF-1024 is not symmetrical. Pin 1 (Port 1) is designed for higher power handling and should be connected to the Tx/Rx block; Pin 4 (Port 2) is connected to the system antenna.

High isolation between Input and Output is achieved by:

1. Maintaining a continuous ground plane around the I/O connections and filter land print area, and
2. Surrounding the I/O ports with sufficient ground vias to enclose the connections in a "Faraday cage."

Due to the limitation of the PCB via to PCB thickness aspect ratio, micro vias ($\text{Ø } 0.100$) are used in the area between land pads to connect metal Layer1 and Layer2. For all other areas, larger thru vias are used to connect all layers.

Ground vias under the ACFF-1024 mounting area also provide heat sinking for the device to minimize shifting of the pass band over temperature.

Table 1. PCB Stack-up

Layer	Type	Material	Thickness (mm)	Dielectric Constant (ϵ_r)
Layer 1	Conductor	Copper	0.055	
	Dielectric	Nelco N4000 13EP	0.075	3.4
Layer 2	Conductor	Copper	0.040	
	Dielectric	Nelco N4000 13EP	0.590	3.4
Layer 3	Conductor	Copper	0.040	
	Dielectric	Nelco N4000 13EP	0.075	3.4
Layer 4	Conductor	Copper	0.055	

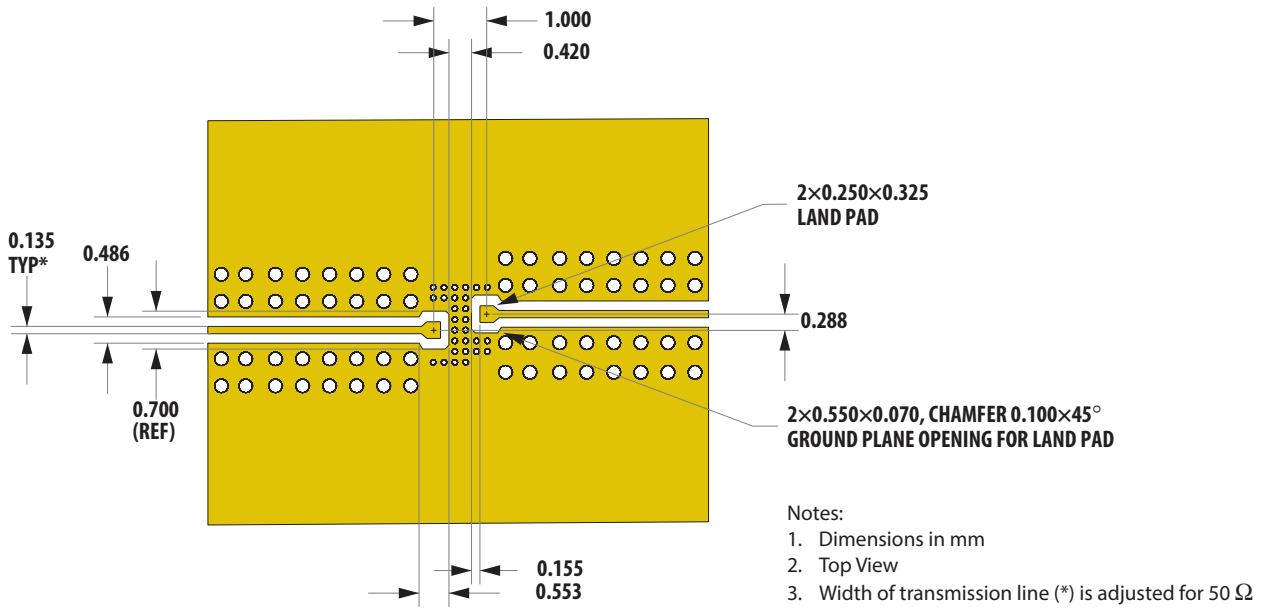

Figure 17. Recommended PCB Layout

A recommended PCB layout design is shown in Figure 17. Transmission line dimensions (*) should be adjusted to maintain Z_o of 50 Ω.

The land pads of this PCB pattern are 1:1 with the ACFF-1024 bottom metal pads.

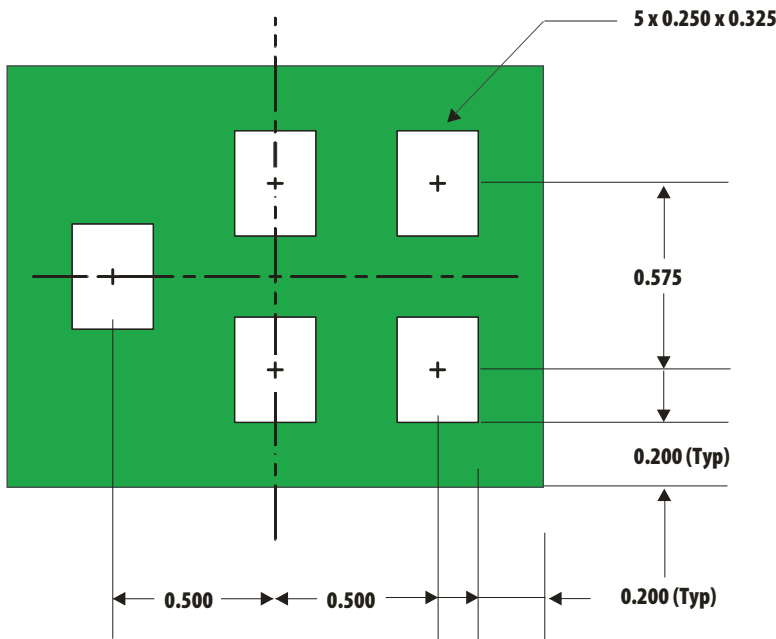

Figure 18. Recommended Solder Mask (Dimensions in mm)

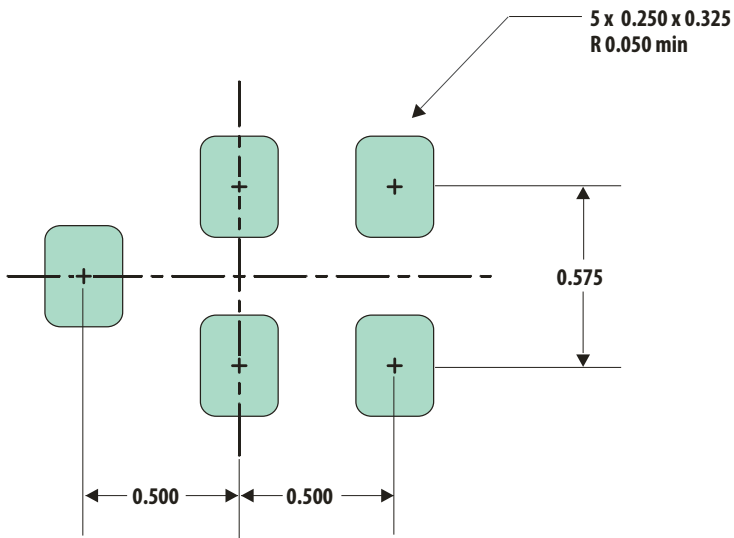

Figure 19. Recommended Solder Stencil (Dimensions in mm)

The recommended solder stencil is designed such that the apertures match the opening in the solder mask 1:1.

A minimum corner radius of 50 μm is recommended to increase reliability of solder paste release from the stencil.

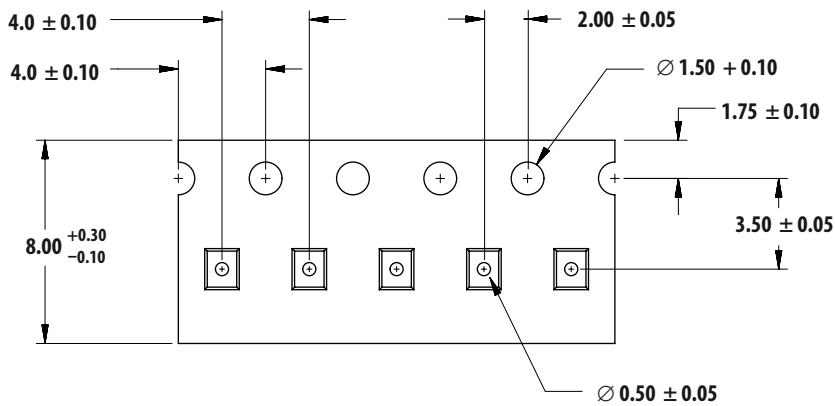

Figure 20. SMT Tape Packing

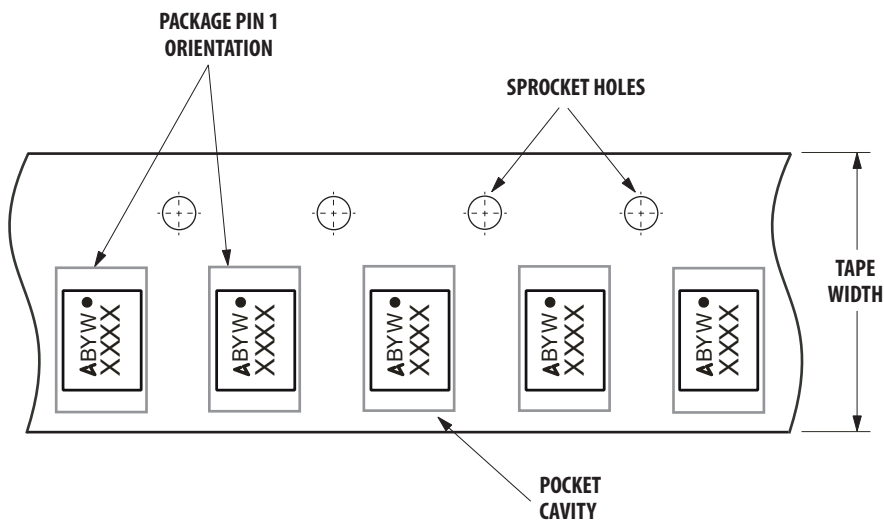
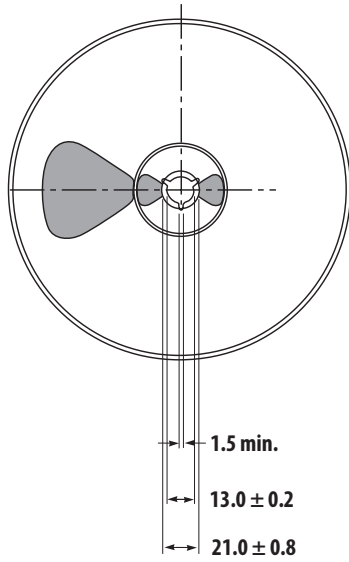

Figure 21. Orientation in Tape

FRONT VIEW



NOTES:

1. Reel shall be labeled with the following information (as a minimum).
 - a. manufacturer's name or symbol
 - b. Avago Technologies part number
 - c. purchase order number
 - d. date code
 - e. quantity of units
2. A certificate of compliance (c of c) shall be issued and accompany each shipment of product.
3. Reel must not be made with or contain ozone depleting materials.
4. All dimensions in millimeters (mm)

BACK VIEW

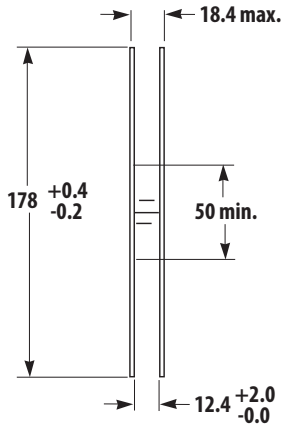
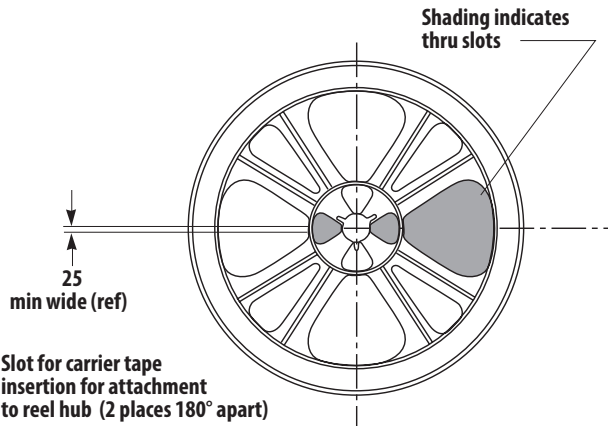

Figure 22. SMT Reel Drawing

Package Moisture Sensitivity

Feature	Test Method	Performance
Moisture Sensitivity Level (MSL) at 260 °C	JESD22-A113D	Level 3

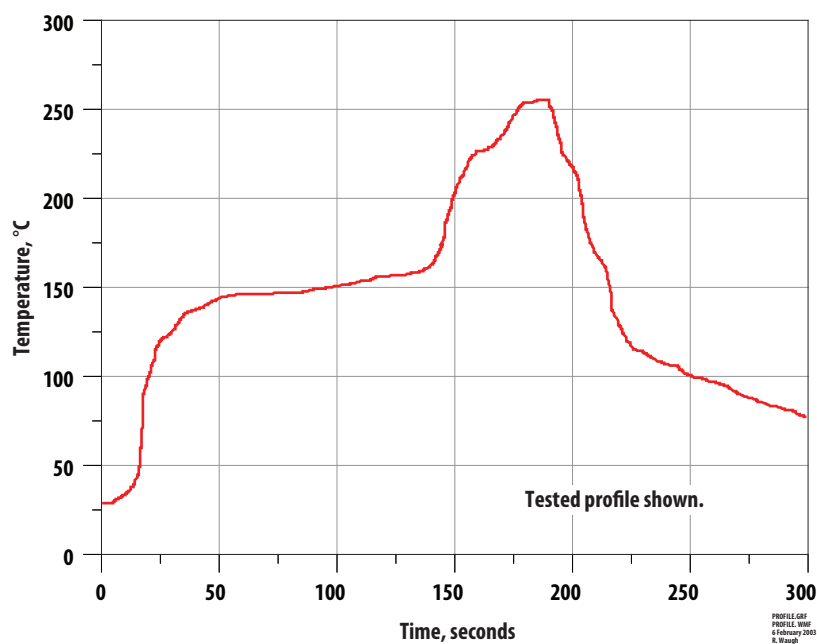

Figure 23. Verified SMT Solder Profile

Ordering Information

Part Number	No. of Devices	Container
ACFF-1024-BLK	100	Tape strip in Anti-static bag
ACFF-1024-TR1	3000	7-inch (178 mm) Reel

For product information and a complete list of distributors, please go to our web site: www.avagotech.com

Avago, Avago Technologies, and the A logo are trademarks of Avago Technologies in the United States and other countries. Data subject to change. Copyright © 2005-2014 Avago Technologies. All rights reserved.
AV02-3973EN - October 2, 2014

Avago
TECHNOLOGIES