

Chipsmall Limited consists of a professional team with an average of over 10 year of expertise in the distribution of electronic components. Based in Hongkong, we have already established firm and mutual-benefit business relationships with customers from,Europe,America and south Asia,supplying obsolete and hard-to-find components to meet their specific needs.

With the principle of “Quality Parts,Customers Priority,Honest Operation,and Considerate Service”,our business mainly focus on the distribution of electronic components. Line cards we deal with include Microchip,ALPS,ROHM,Xilinx,Pulse,ON,Everlight and Freescale. Main products comprise IC,Modules,Potentiometer,IC Socket,Relay,Connector.Our parts cover such applications as commercial,industrial, and automotives areas.

We are looking forward to setting up business relationship with you and hope to provide you with the best service and solution. Let us make a better world for our industry!



Contact us

Tel: +86-755-8981 8866 Fax: +86-755-8427 6832

Email & Skype: info@chipsmall.com Web: www.chipsmall.com

Address: A1208, Overseas Decoration Building, #122 Zhenhua RD., Futian, Shenzhen, China

ACFM-7103

PCS/Cellular/S-GPS Quintplexer



Data Sheet

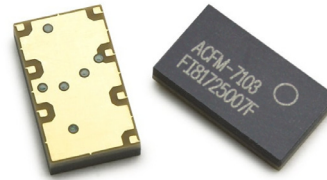

Description

The Avago Technologies' ACFM-7103 is a reduced size quintplexer that combines PCS and Cellular duplexer functions with a GPS filter. This device simplifies handset applications that are designed for simultaneous voice service and GPS positioning.

The ACFM-7103 features two antenna connections, one for the duplexers and a separate antenna port for the GPS filter. The ACFM-7103 can be used for single antenna applications by simply connecting both antenna terminals together with a single, external SMT component.

The ACFM-7103 is designed with Avago Technologies' Film Bulk Acoustic Resonator (FBAR) technology. The ACFM-7103 also utilizes Avago Technologies' innovative Microcap bonded-wafer, chip scale packaging technology. This process allows the filters to be assembled in a module with a footprint of only 4 x 7 mm and maximum height of 1.2 mm.

Low Tx Insertion Loss reduces power amplifier current, extending battery life and talk time. The ACFM-7103 enhances receiver sensitivity and dynamic range with low Rx Insertion Loss and high rejection of Tx signals at the Rx ports.

The excellent power handling capability of Avago Technologies' FBAR bulk-mode resonators supports the high Tx output power levels needed in handsets while adding virtually no distortion.

Functional Block Diagram

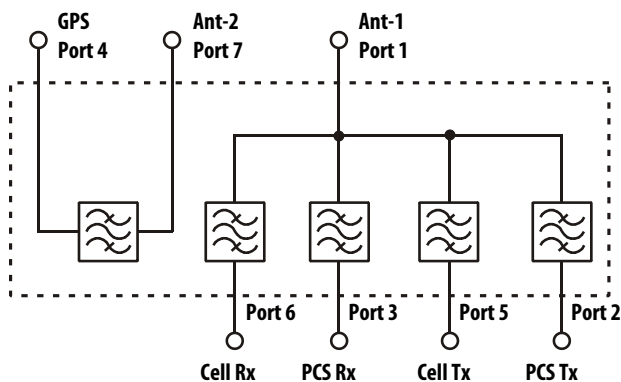

Features

- Dual/Single Antenna Options
 - Single Antenna connection for PCS and Cell band duplexers
 - Separate GPS Antenna connection
 - Duplexer and GPS antennas can be connected together with an inductor for single antenna applications
- Miniature size
 - 4 x 7 mm footprint
 - 1.2 mm Max height
- High Power Rating
 - +33 dBm Max Tx Power
- RoHS Compliant

Specifications

- Performance guaranteed -30 to +85°C
- GPS Filter (1574.4–1576.4 MHz)
 - Insertion Loss: 1.7 dB Max, 0.8 dB Typ (25°C)
 - Isolation in PCS: 45 dB Min, Cell Tx: 50 dB Min
- Cellular Duplexer Rx (869 – 894 MHz)
 - Insertion Loss: 3.6 dB Max, 1.5 dB Typ (25°C)
 - Noise Blocking: 40 dB Min
- Cellular Duplexer Tx (824 – 849 MHz)
 - Insertion Loss: 2.9 dB Max, 1.4 dB Typ (25°C)
 - Interferer Blocking: 55 dB Min
- PCS Duplexer Rx (1930.5 – 1989.5 MHz)
 - Insertion Loss: 3.6 dB Max, 1.6 dB Typ (25°C)
 - Noise Blocking: 40 dB Min
- PCS Duplexer Tx (1850.5 – 1909.5 MHz)
 - Insertion Loss: 3.1 dB Max, 1.5 dB Typ (25°C)
 - Interferer Blocking: 53 dB Min

Applications

- Handsets or data terminals operating in the PCS and Cellular frequency bands with simultaneous GPS positioning capability

ACFM-7103 Electrical Specifications, T_c [1][2] as indicated, Dual Antenna Connection [4]

Symbol	Parameter	Units	- 30°C			+25°C			+85°C		
			Min	Typ ^[3]	Max	Min	Typ ^[3]	Max	Min	Typ ^[3]	Max
GPS Filter Performance											
Antenna–2 Port to GPS Receive Port											
S47	Insertion Loss in GPS Band (L1) (1574.4–1576.4 MHz)	dB			1.6		0.8	1.6			1.7
S47	Insertion Loss Ripple (p-p) in GPS Band	dB						0.5			
S44	Return Loss of GPS Port in GPS Band	dB	9			9	20		9		
S77	Return Loss of Antenna–2 Port in GPS Band	dB	9			9	23		9		
Isolation – Cellular Transmit Port to GPS Port^[5]											
S45	Isolation in Cellular Tx Band (824–849 MHz)	dB	50			50	54		50		
S45	Isolation in GPS Band (1574.4–1576.4 MHz)	dB	40			40	55		40		
Isolation – PCS Transmit Port to GPS Port^[5]											
S42	Isolation in PCS Tx Band (1850.5 – 1909.5 MHz)	dB	45			45	51		45		
S42	Isolation in GPS Band (1574.4–1576.4 MHz)	dB	40			40	46		40		
Cellular Duplexer Performance											
Antenna–1 Port to Cellular Receive Port											
S61	Insertion Loss in Rx band (869–894 MHz)	dB			3.6		1.5	3.6			3.6
S61	Insertion Loss Ripple (p-p) in Rx Band	dB						1.5			
S61	Attenuation in Tx band (824–849 MHz)	dB	55			55	66		50		
S61	Attenuation 0–804 MHz	dB	25			25	36		25		
S61	Attenuation in Tx 2 nd harmonic band (1648–1698 MHz)	dB	30			30	54		30		
S61	Attenuation in Tx 3 rd harmonic band (2472–2547 MHz)	dB	19			19	44		19		
S66	Return Loss of Rx Port in Rx Band (869–894 MHz)	dB	9			9	17		9		
S11	Return Loss of Antenna–1 Port in Rx Band (869–894 MHz)	dB	9			9	17		9		

ACFM-7103 Electrical Specifications, T_c [1][2] as indicated, Dual Antenna Connection [4] (cont)

Symbol	Parameter	Units	- 30°C			+25°C			+85°C		
			Min	Typ [3]	Max	Min	Typ [3]	Max	Min	Typ [3]	Max
Cellular Transmit Port to Antenna-1 Port											
S15	Insertion Loss in Tx band (824-849 MHz)	dB			2.9		1.4	2.9			2.9
S15	Insertion Loss Ripple (p-p) in Tx Band	dB						1.5			
S15	Attenuation in Rx band (869-894 MHz)	dB	39			40	58		37		
S15	Attenuation, 0-804 MHz	dB	20			20	39		20		
S15	Attenuation in GPS band (1574.4-1576.4 MHz)	dB	37			37	48		37		
S15	Attenuation in Tx 2nd harmonic band (1648-1698 MHz)	dB	20			20	46		20		
S15	Attenuation in Tx 3rd harmonic band (2472-2547 MHz)	dB	8			8	25		8		
S55	Return Loss of Tx Port in Tx band (824-849 MHz)	dB	9			9	14		9		
S11	Return Loss of Antenna-1 port in Tx Band (824-849 MHz)	dB	9			9	14		9		
Isolation, Cellular Transmit Port to Cellular Receive Port											
S65	Isolation, Tx to Rx port in Rx Band (869-894 MHz)	dB	40			40	56		40		
S65	Isolation, Tx to Rx port in Tx Band (824-849 MHz)	dB	55			55	67		55		
PCS Duplexer Performance											
Antenna-1 Port to PCS Receive Port											
S31	Insertion Loss in Rx Band (1930.5-1989.5 MHz)	dB			3.6		1.6	3.6			3.6
S31	Insertion Loss Ripple (p-p) in Rx Band	dB						1.5			
S31	Attenuation in Tx Band (1850.5-1909.5 MHz)	dB	50			50	61		50		
S31	Attenuation 0.03-1770 MHz	dB	20			20	41		20		
S31	Attenuation 2025-3700 MHz	dB	30			30	56		30		
S31	Attenuation 3820-4000 MHz	dB	23			23	34		23		
S33	Return Loss of Rx Port in Rx Band (1930.5-1989.5 MHz)	dB	9			9	15		9		
S11	Return Loss of Antenna-1 Port in Rx Band (1930.5-1989.5 MHz)	dB	9			9	17		9		

ACFM-7103 Electrical Specifications, T_C [1][2] as indicated, Dual Antenna Connection [4] (cont)

Symbol	Parameter	Units	- 30°C			+25°C			+85°C		
			Min	Typ [3]	Max	Min	Typ [3]	Max	Min	Typ [3]	Max
PCS Transmit Port to Antenna-1 Port											
S12	Insertion Loss in Tx Band (1850.5–1909.5 MHz)	dB			3.1		1.5	3.1			3.1
S12	Insertion Loss Ripple (p-p) in Tx Band	dB						1.5			
S12	Attenuation in Rx Band (1930.5–1989.5 MHz)	dB	39			39	46		39		
S12	Attenuation 0.03–1570 MHz	dB	15			15	43		15		
S12	Attenuation in GPS Band (1574.4–1576.4 MHz)	dB	37			37	39		37		
S12	Attenuation 1580 – 1700 MHz	dB	25			25	39		25		
S12	Attenuation in Tx 2nd harmonic band (3701–3819 MHz)	dB	10			10	21		10		
S12	Attenuation in Tx 3rd harmonic band (5551.5–5728.5 MHz)	dB	8			8	32		8		
S22	Return Loss of Tx Port in Tx band (1850.5–1909.5 MHz)	dB	9.5			9.5	15		9.5		
S11	Return Loss of Antenna-1 port in Tx Band (1850.5–1909.5 MHz)	dB	9			9	14		9		
Isolation, PCS Transmit Port to PCS Receive Port											
S32	Isolation, Tx to Rx port in Rx Band (1930.5–1989.5 MHz)	dB	40			40	51		40		
S32	Isolation, Tx to Rx port in Tx Band (1850.5–1855 MHz)	dB	53			53	64		53		
	(1855–1909.5 MHz)		54			54	64		54		

Notes:

1. T_C is the case temperature and is defined as the temperature of the underside of the quintplexer where it makes contact with the circuit board.
2. Min/Max specifications are guaranteed at the indicated temperature with the input power to the Tx ports equal to or less than +29 dBm over all Tx frequencies unless otherwise noted.
3. Typical data is the arithmetic mean value of the parameter over its indicated frequency range at the specified temperature. Typical values may vary over time.
4. Unless otherwise noted, specifications are for Dual Antenna connection as shown in Figure 1 and include effect of 5.1 nH inductor and 1.0 pF capacitor added to Port 1 (Ant-1) via simulation.
5. Specifications are for Single Antenna connection as shown in Figure 2 and includes effect of 5.1 nH inductor added between Port 1 (Ant-1) and Port 7 (Ant-2) via simulation.

Absolute Maximum Ratings^[1]

Parameter	Unit	Value
Storage temperature	°C	-65 to +125
Maximum RF Input Power to Tx Ports	dBm	+33

Maximum Recommended Operating Conditions^[2]

Parameter	Unit	Value
Operating temperature, T_c ^[3] , Tx Power \leq 29 dBm	°C	-40 to +100
Operating temperature, T_c ^[3] , Tx Power \leq 30 dBm	°C	-40 to +85

Notes:

1. Operation in excess of any one of these conditions may result in permanent damage to the device.
2. The device will function over the recommended range without degradation in reliability or permanent change in performance, but is not guaranteed to meet electrical specifications.
3. T_c is defined as case temperature, the temperature of the underside of the quintplexer where it makes contact with the circuit board.

Applications Information

The ACFM-7103 quintplexer has two antenna connections, one common to the Cellular and PCS Band duplexers, and a separate antenna for the GPS filter.

Dual Antenna Operation

For applications in which a separate GPS antenna is preferred, the ACFM-7103 can be connected as shown in Figure 1.

A series-L, shunt-C network is used to match the impedance of the Ant-1 port (duplexers) to the phone antenna. A nominal inductance value of 5.1 nH and capacitance of 1.0 pF matches the Ant-1 port to 50 ohms.

The GPS antenna (Ant-2) is internally matched to 50 ohms and needs no external components.

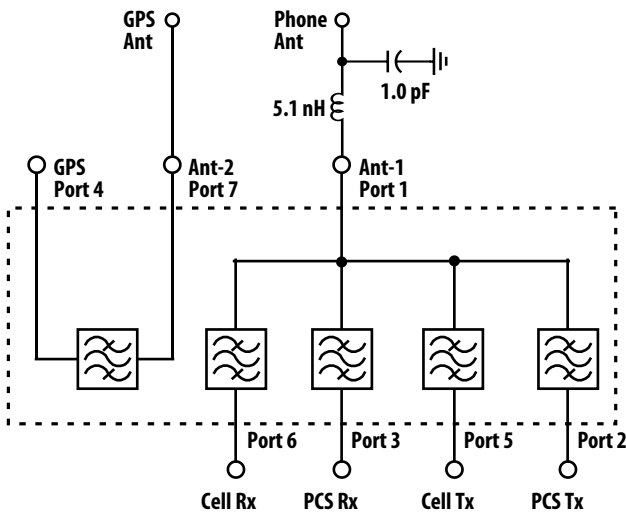

Figure 1. Dual Antenna Application.

Single Antenna Operation

Optionally, if single antenna operation is required, the Ant-1 and Ant-2 ports of the ACFM-7103 can be connected together as in Figure 2.

A single 5.1 nH inductor connected between Ant-1 and Ant-2 is all that is required to match both antenna ports to a common 50-ohm antenna.

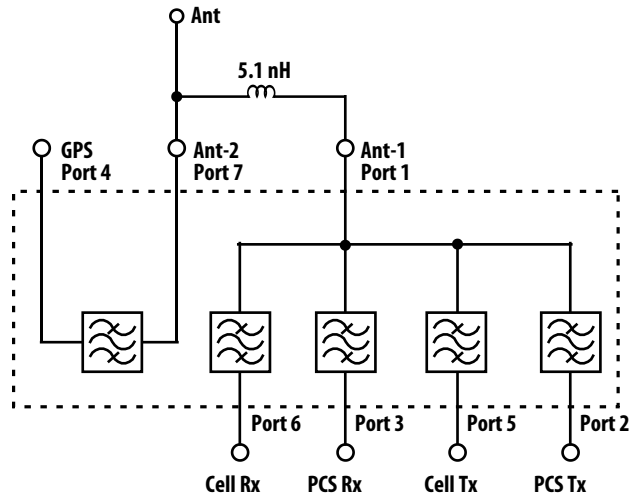

Figure 2. Single Antenna Application.

Matching Components

The L and C values shown here were selected to match the ACFM-7103 to 50 ohms. These values should be considered to be nominal. Since every application is different, these nominal values should be adjusted to provide the best impedance match for the user's particular circuit board, performance requirements, and interface to related components.

The L and C matching components should be located in close proximity to the quintplexer as shown in the recommended PCB layouts.

For both antenna configurations, the maximum variation for the matching components should be $\pm 5\%$ for the inductor and ± 0.2 pF for the capacitor. The inductor should be of the high Q type (e.g., Murata LQW15AN5N1D00D).

ACFM-7103 Typical Performance at $T_c = 25^\circ\text{C}$

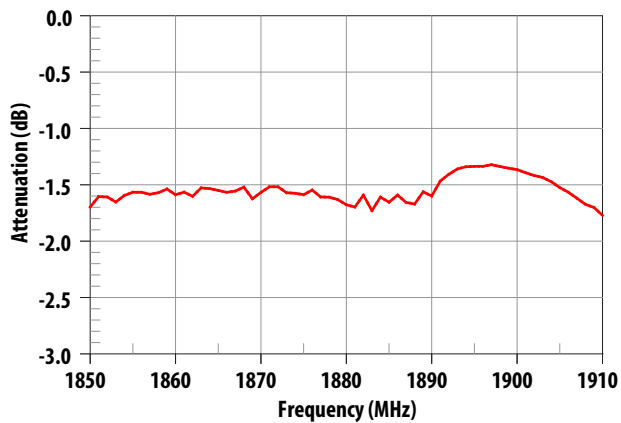

Figure 3. PCS Tx Band Insertion Loss (Dual Antenna, Note1).

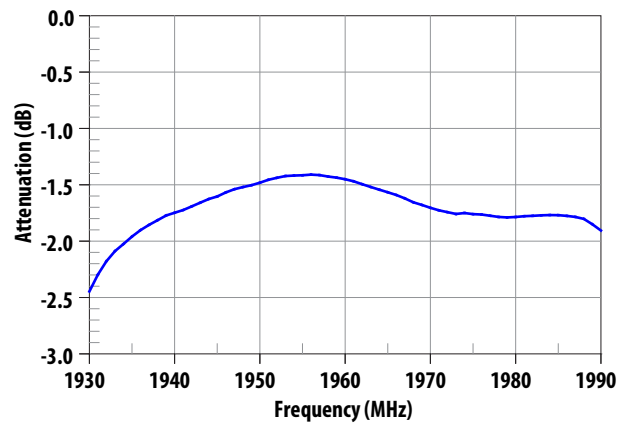

Figure 4. PCS Rx Band Insertion Loss (Dual Antenna, Note1).

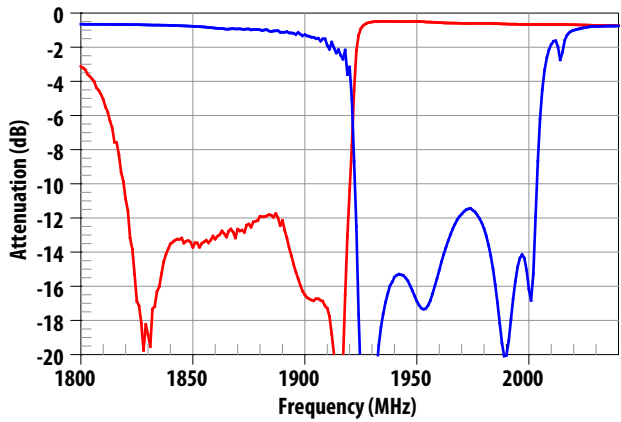

Figure 5. PCS Tx and Rx Port Return Loss (Dual Antenna, Note1).

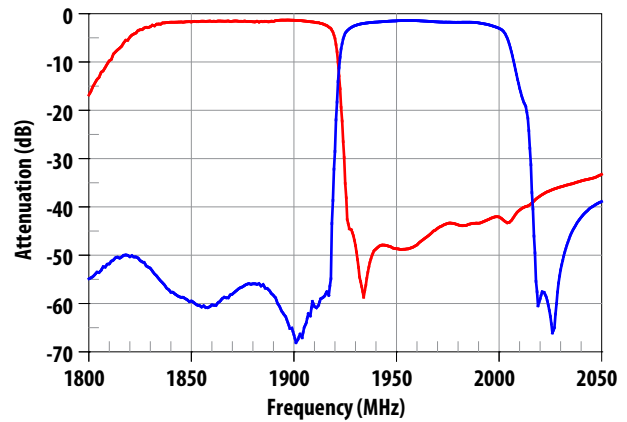

Figure 6. PCS Tx Rejection in Rx Band and Rx Rejection in Tx Band (Dual Antenna, Note1).

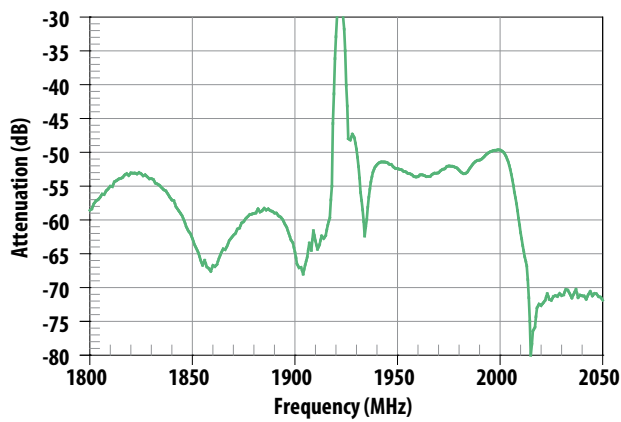

Figure 7. PCS Tx-Rx Isolation (Dual Antenna, Note1).

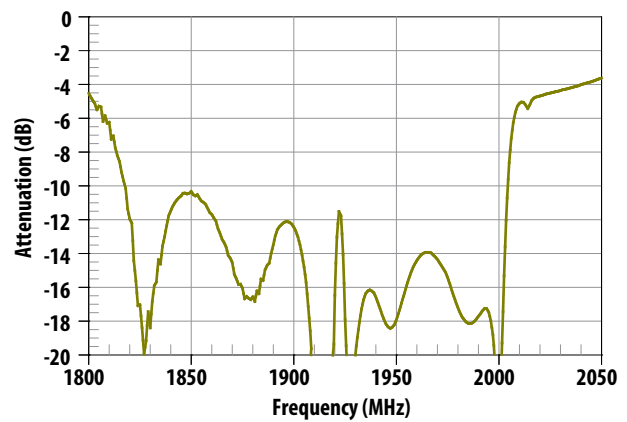

Figure 8. PCS Antenna Port Return Loss (Dual Antenna, Note1).

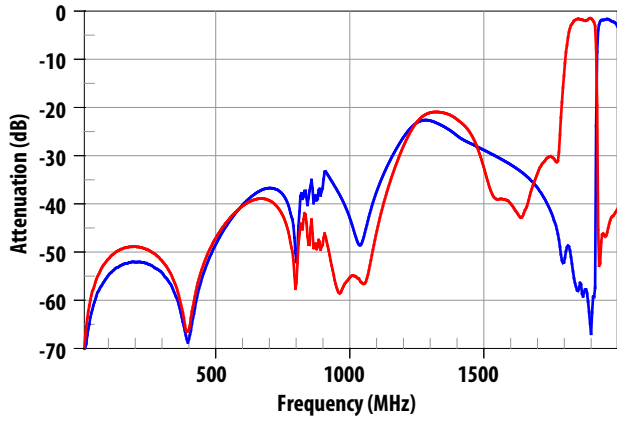

Figure 9. PCS Tx-Ant and Ant-Rx Low Frequency Insertion Loss (Dual Antenna, Note1).

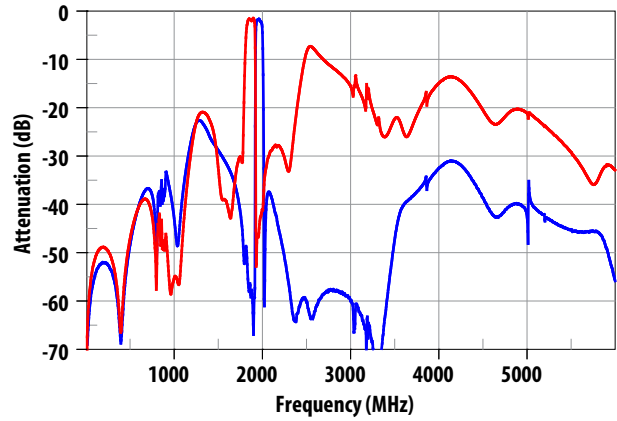

Figure 10. PCS Tx-Ant and Ant-Rx Wideband Insertion Loss (Dual Antenna, Note1).

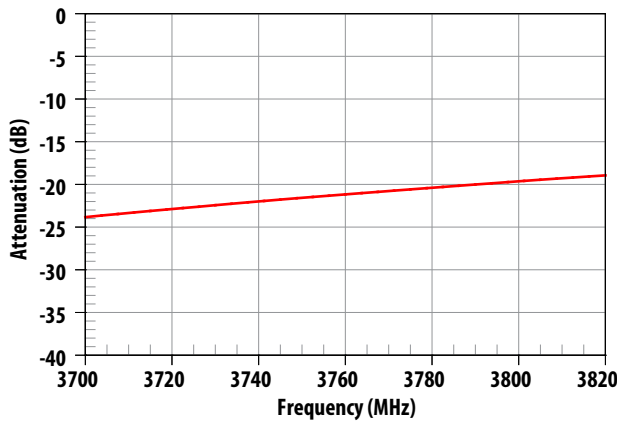

Figure 11. PCS Tx-Ant Rejection at Tx Second Harmonic (Dual Antenna, Note1).

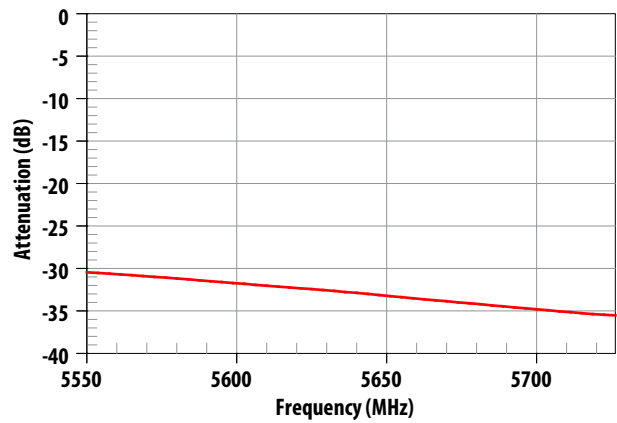

Figure 12. PCS Ant-Tx Rejection at Tx Third Harmonic (Dual Antenna, Note1).

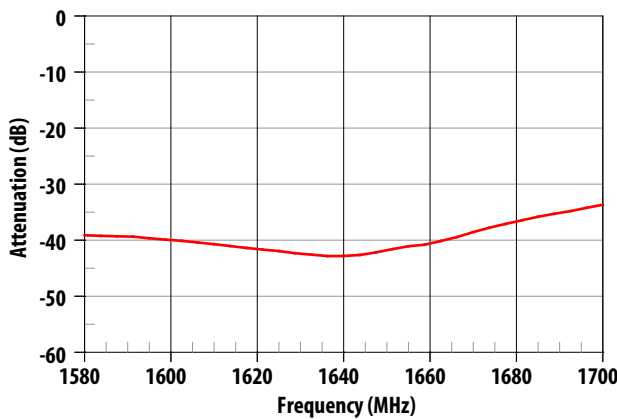

Figure 13. PCS Ant-Tx Rejection, 1580-1700 MHz (Dual Antenna, Note1).

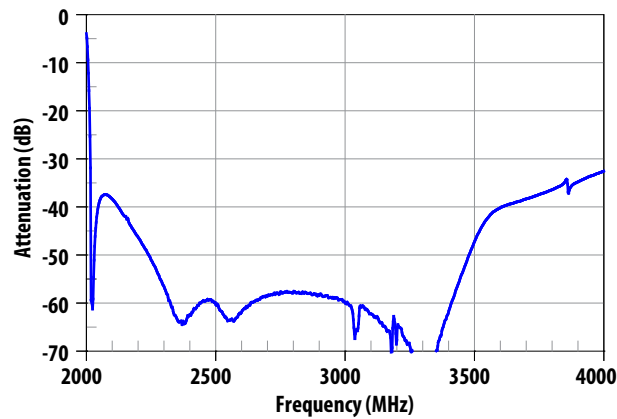

Figure 14. PCS Ant-Rx Rejection, 2000-4000 MHz (Dual Antenna, Note1).

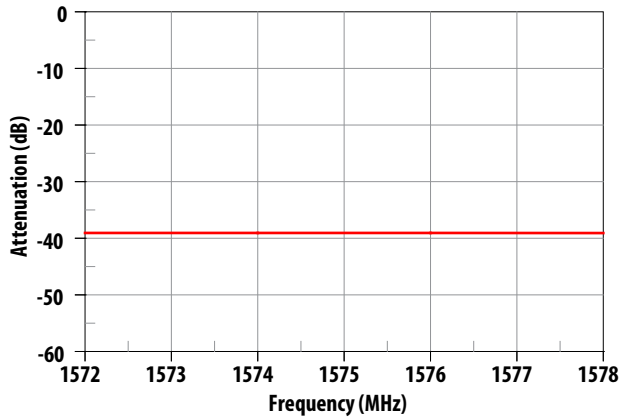

Figure 15. PCS Tx-Ant Rejection at GPS (Dual Antenna, Note1).

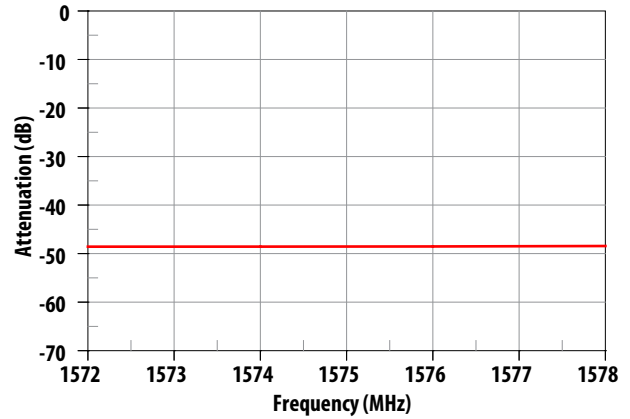

Figure 16. Cell Tx-Ant Rejection at GPS (Dual Antenna, Note1).

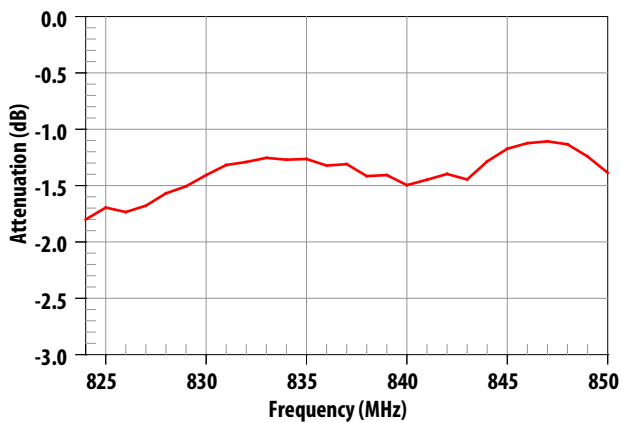

Figure 17. Cellular Tx Insertion Loss (Dual Antenna, Note1).

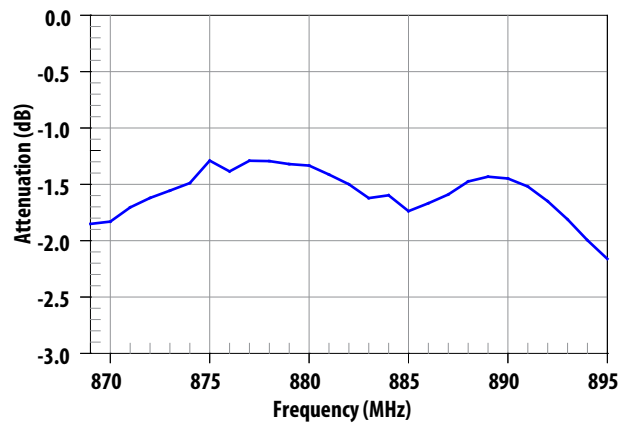

Figure 18. Cellular Rx Insertion Loss (Dual Antenna, Note1).

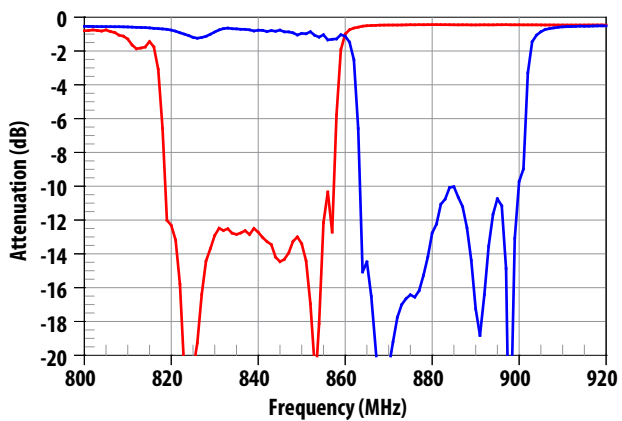

Figure 19. Cellular Tx and Rx Return Loss (Dual Antenna, Note1).

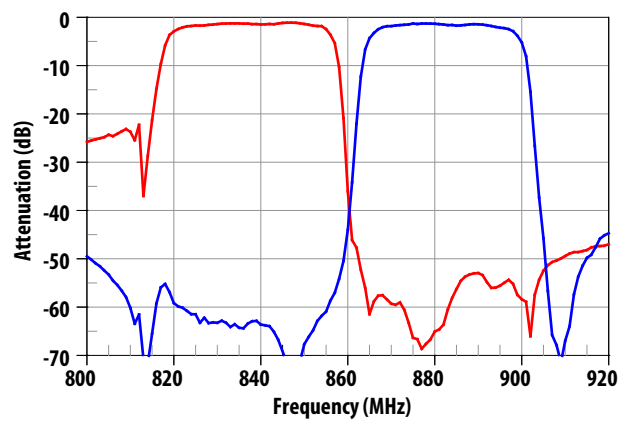

Figure 20. Cellular Tx Rejection in Rx Band and Rx Rejection in Tx Band (Dual Antenna, Note1).

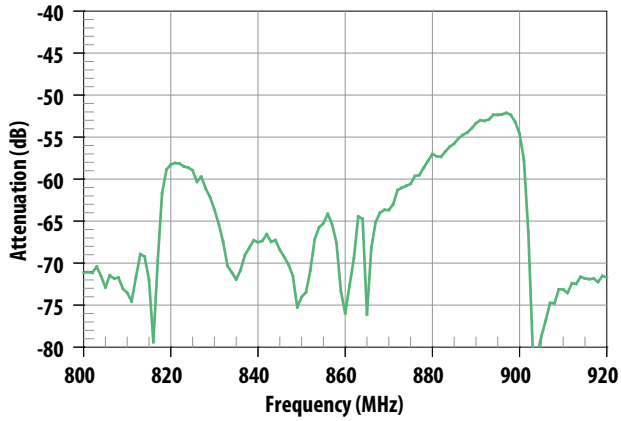

Figure 21. Cellular Tx-Rx Isolation (Dual Antenna, Note1).

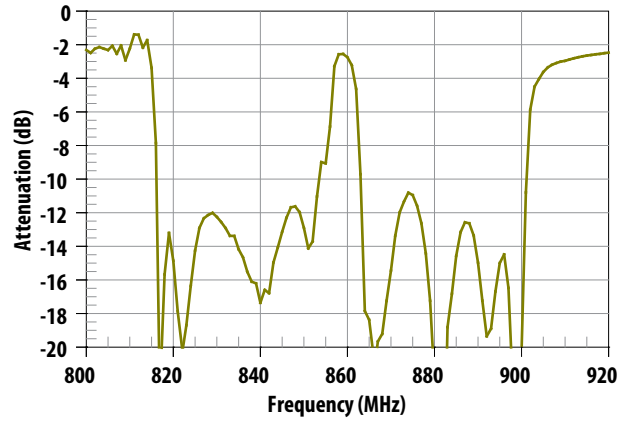

Figure 22. Cellular Band Antenna Return Loss (Dual Antenna, Note1).

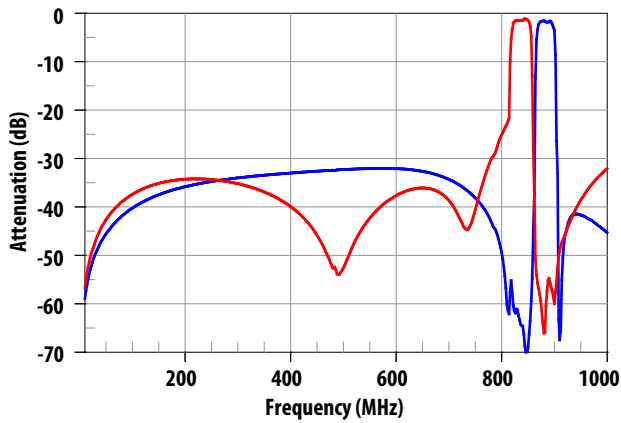

Figure 23. Cellular Tx-Ant and Ant-Rx Low Frequency Insertion Loss (Dual Antenna, Note1).

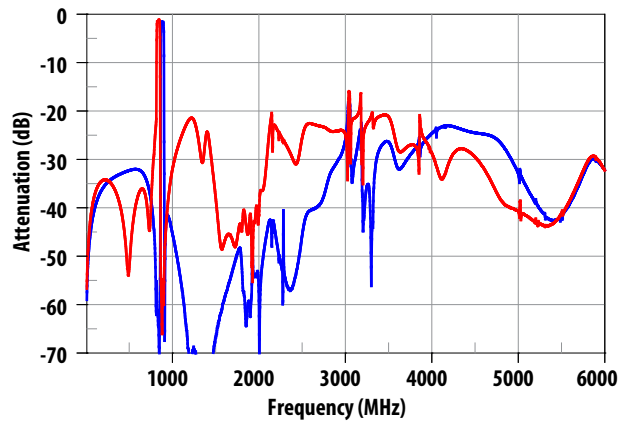

Figure 24. Cellular Tx-Ant and Ant-Rx Wideband Insertion Loss (Dual Antenna, Note1).

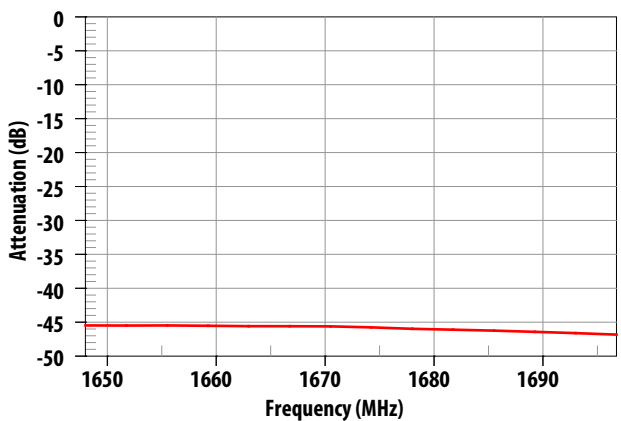

Figure 25. Cellular Tx-Ant Rejection at Tx Second Harmonic (Dual Antenna, Note1).

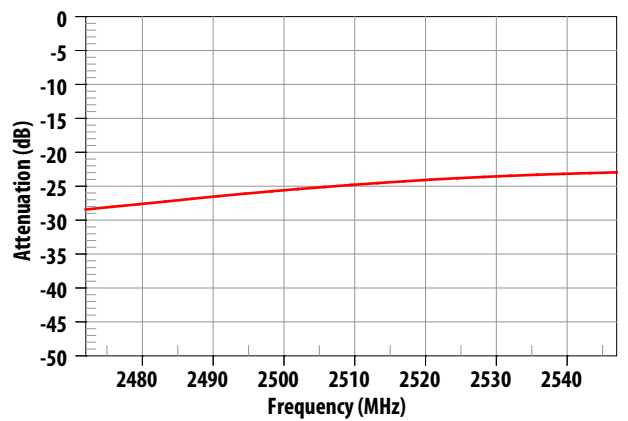

Figure 26. Cellular Tx-Ant Rejection at Tx Third Harmonic (Dual Antenna, Note1).

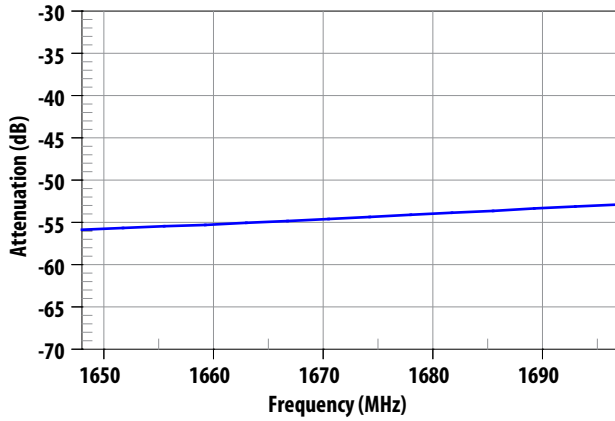

Figure 27. Cellular Ant-Rx Rejection at Tx Second Harmonic (Dual Antenna, Note1).

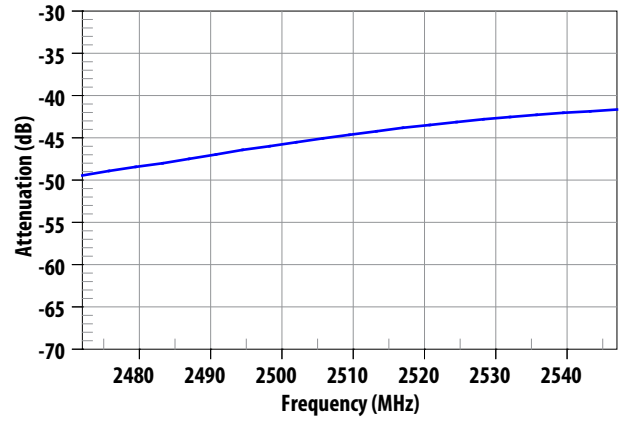

Figure 28. Cellular Ant-Rx Rejection at Tx Third Harmonic (Dual Antenna, Note1).

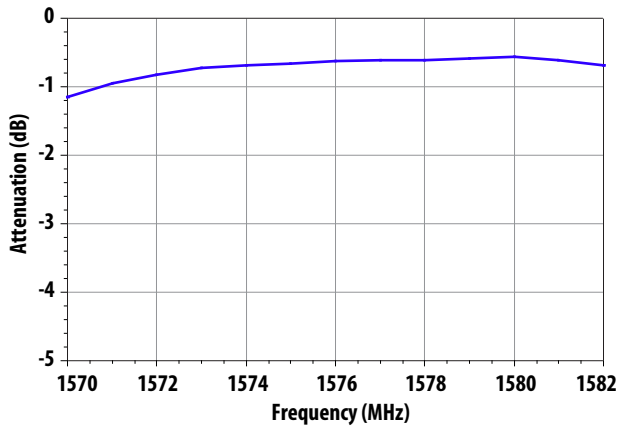

Figure 29. Ant-GPS Insertion Loss (Dual Antenna, Note1).

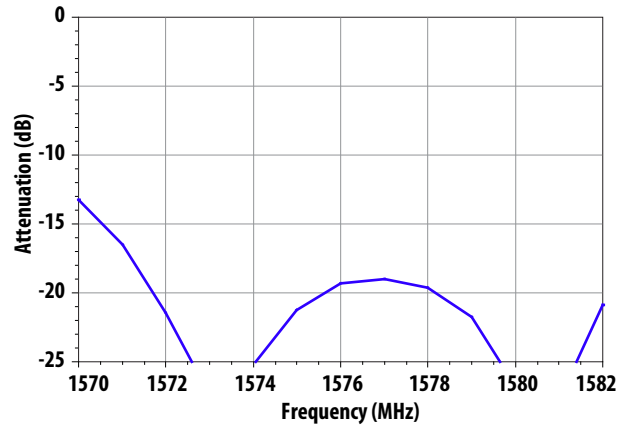

Figure 30. GPS Port Return Loss (Dual Antenna, Note1).

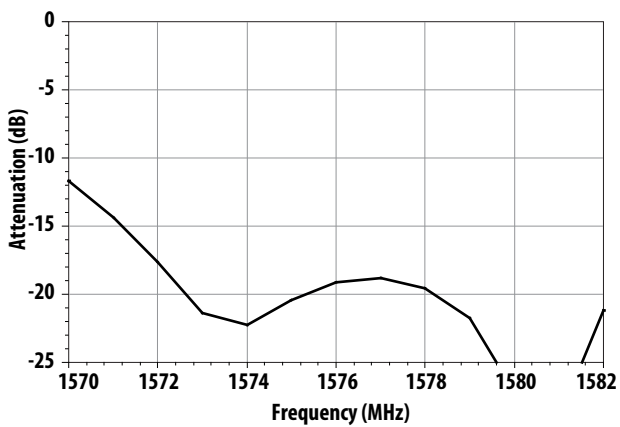

Figure 31. Antenna Port Return Loss in GPS Band (Dual Antenna, Note1).

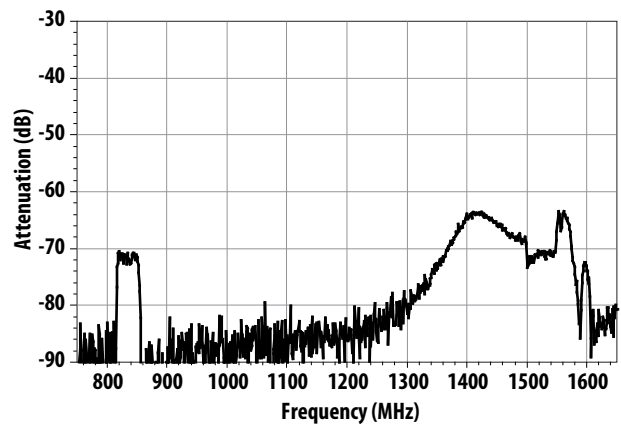

Figure 32. Cellular Tx Port to GPS Port Isolation (Dual Antenna, Note1).

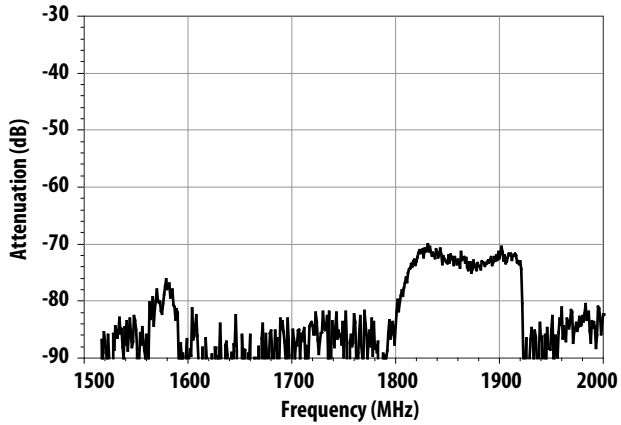

Figure 33. PCS Tx Port to GPS Port Isolation (Dual Antenna, Note1).

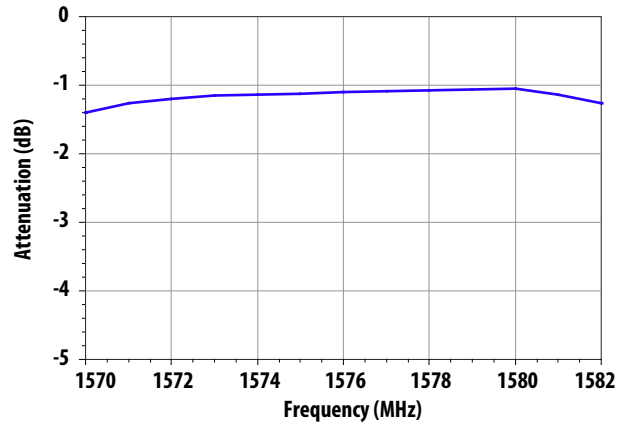

Figure 34. GPS Port Insertion Loss (Single Antenna, Note2).

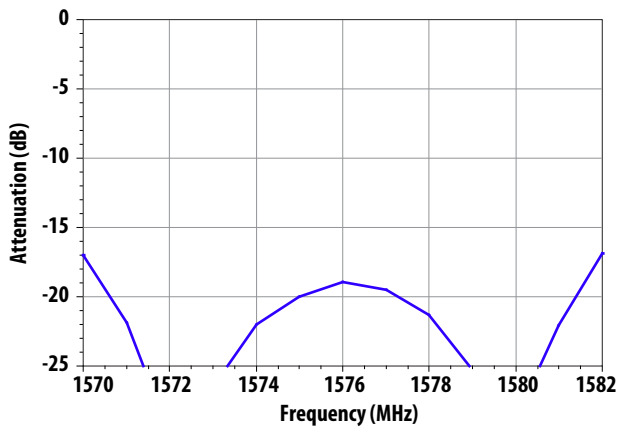

Figure 35. GPS Port Return Loss (Single Antenna, Note2).

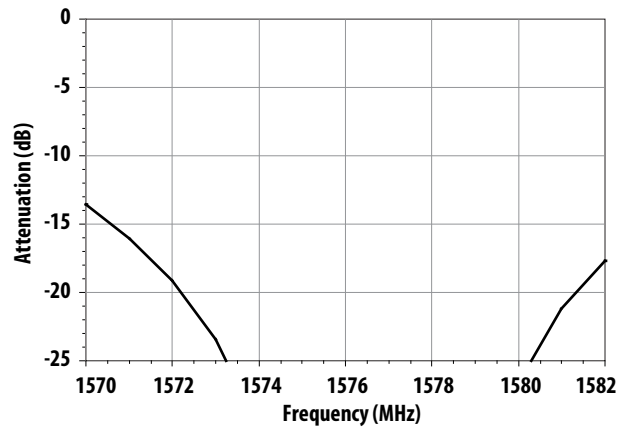

Figure 36. GPS Ant Port RL in GPS Band (Single Antenna, Note2).

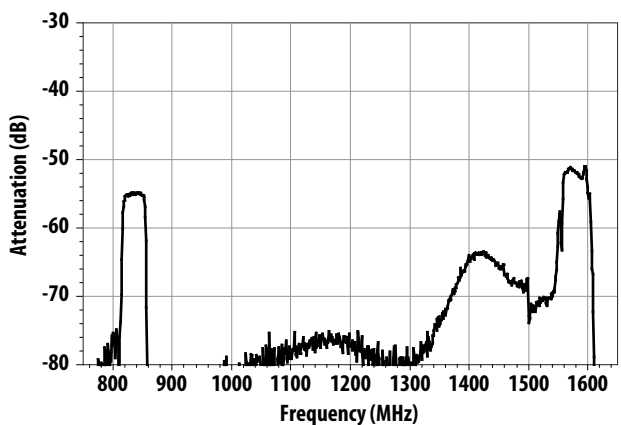

Figure 37. Cell Tx Port to GPS Port Isolation (Single Antenna, Note2).

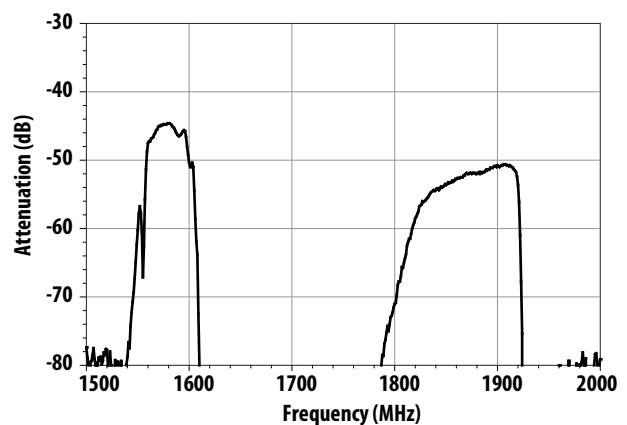
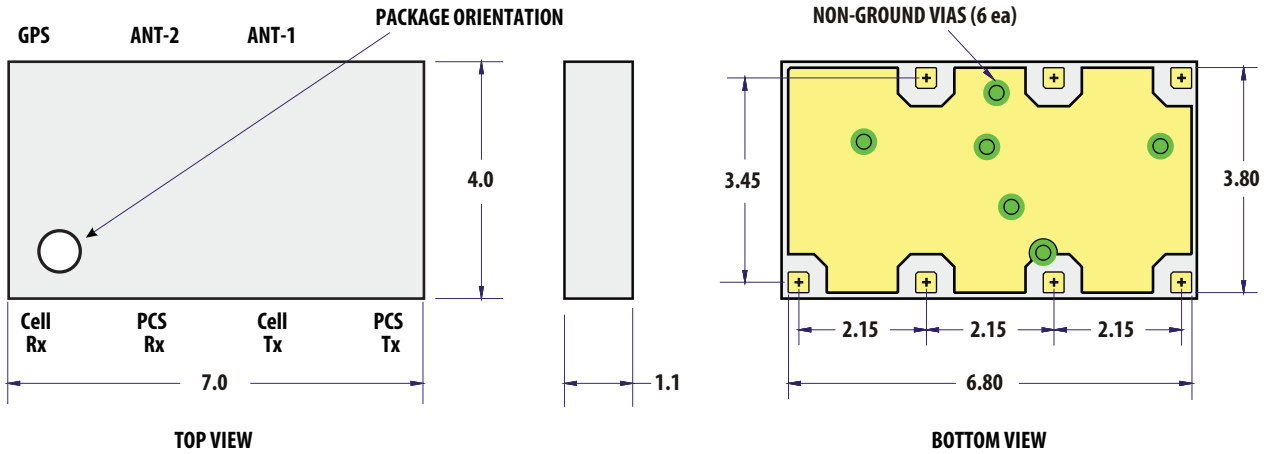

Figure 38. PCS Tx Port to GPS Port Isolation (Single Antenna, Note2).

Notes:

1. Dual Antenna connection as shown in Figure 1. Data measured with $Z_0=50 \Omega$ for all ports; performance shown includes effect of 5.1 nH inductor and 1.0 pF capacitor added to Port 1 (Ant-1) via simulation.
2. Single Antenna connection as shown in Figure 2. Data measured with $Z_0=50 \Omega$ for all ports; performance shown includes effect of 5.1 nH inductor added to Port 1 (Ant-1) and Port 7 (Ant-2) via simulation.



- Notes:
1. Dimensions in mm
 2. Tolerance: X.X ± 0.1, X.XX ± 0.05
 3. Max OD: 4.1 x 7.1 x 1.2 mm
 4. IO pads (7 ea), 0.35 x 0.35, pad to ground plane spacing = 0.03
 5. Non-ground vias (6 ea) shown for reference only; covered with 0.35 φ solder mask
Note: PCB metal on mother board under non-ground vias does not need to be voided
 6. Contact areas are gold plated

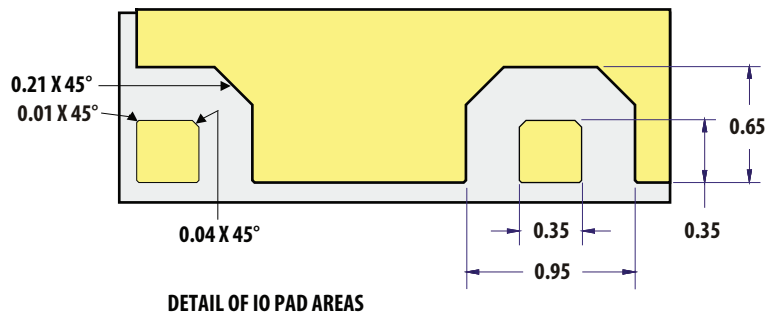

Figure 39. Package Outline Drawing.

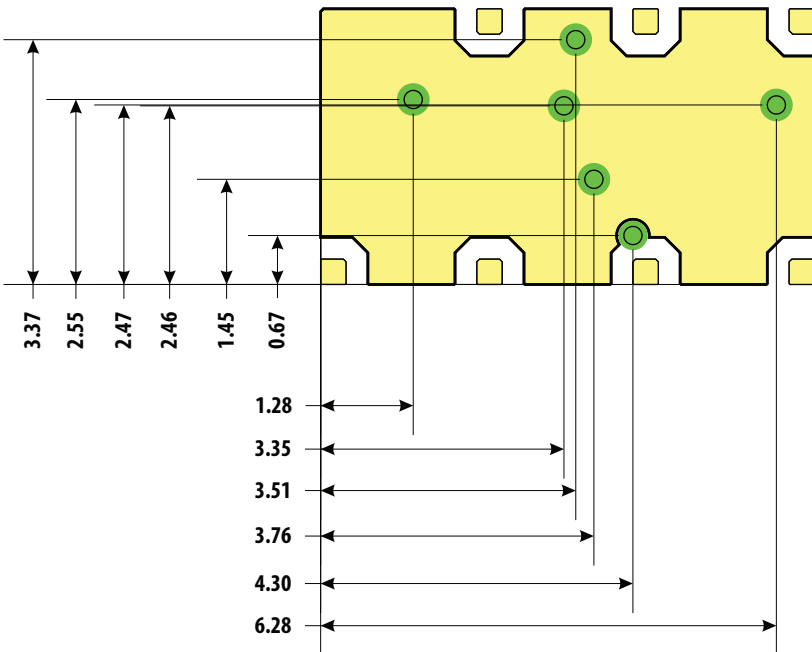
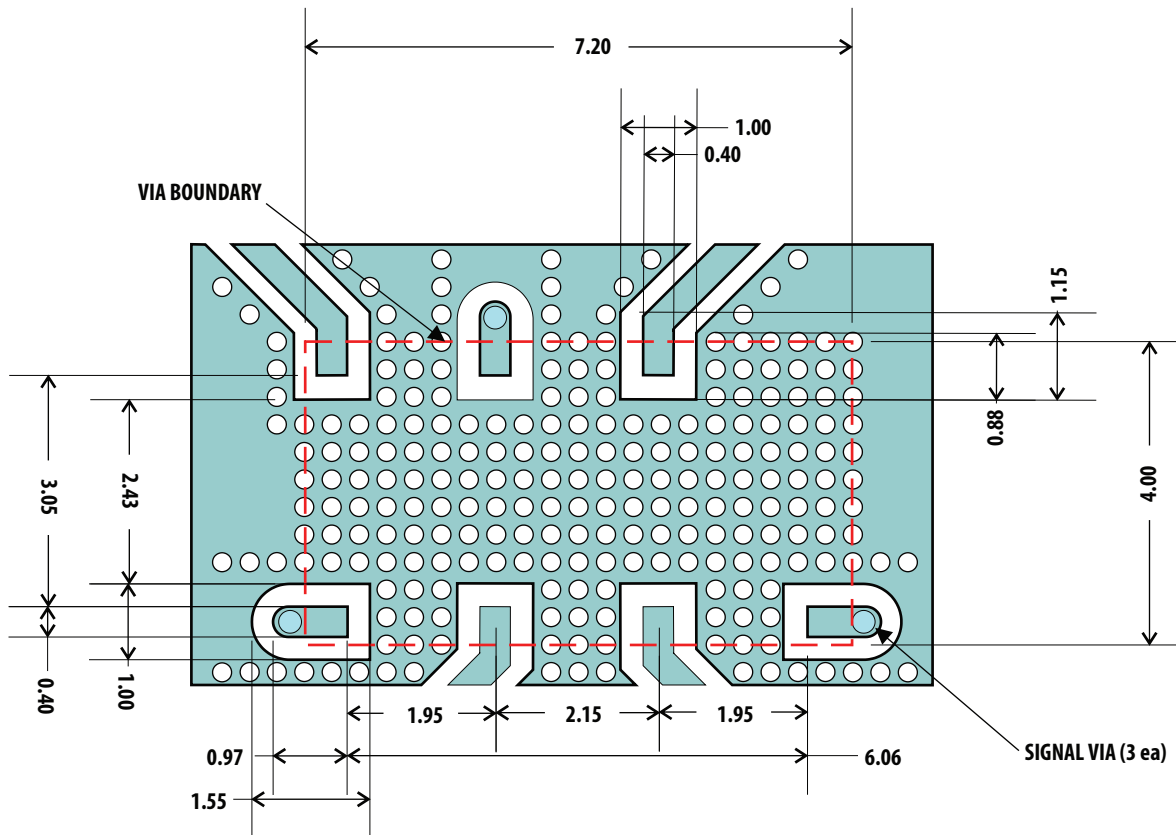

Figure 40. Locations of Non-Ground (Signal) Vias.



Notes:

1. Dimensions in mm
2. I/O pattern centered on device location
3. I/O connections are CPW; dimensions adjusted so $Z_0 = 50$ ohms
4. Via Boundary rectangle 7.20×4.00 , centered on device location
5. Ground vias are $\phi 0.25$, aligned to 0.36×0.36 grid
6. Ground vias positioned for optimum RF performance, port-to-port isolation, and device heat sinking
7. Optional: Signal vias (3 ea) are $\phi 0.30$ and feed through to bottom buried metal pattern for ANT-2, Cell-Rx, and PCS-Tx connections
8. Length of lines extending from all ports should be minimized to maintain port-to-port isolation
9. Ant-1, GPS lines and PCS-Rx, Cell-Tx lines should be orthogonal to maintain port-to-port isolation

Figure 41. Suggested PCB Land Pattern for Dual Antenna Connection (top view).

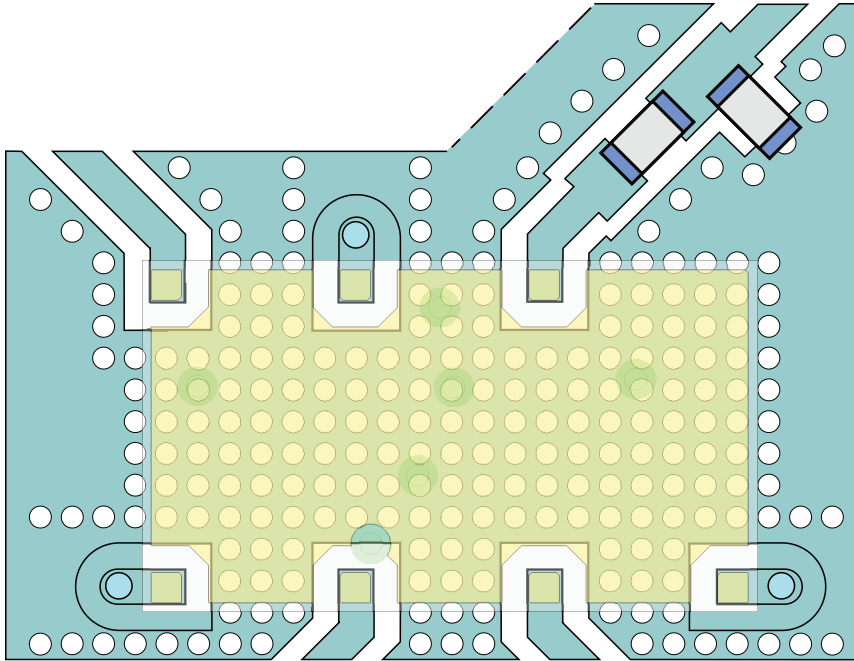

Figure 42. Suggested PCB Land Pattern for Dual Antenna Connection (top view).

Notes:

1. Dimensions and detail follow same general schema as Figure 41.
2. Includes provision for 0402 size matching components for Ant-1.
3. Suggested I/O connections for Ant-2, Cell-Rx, and PCS-Tx are preferably located on a buried metal layer to maintain best isolation.

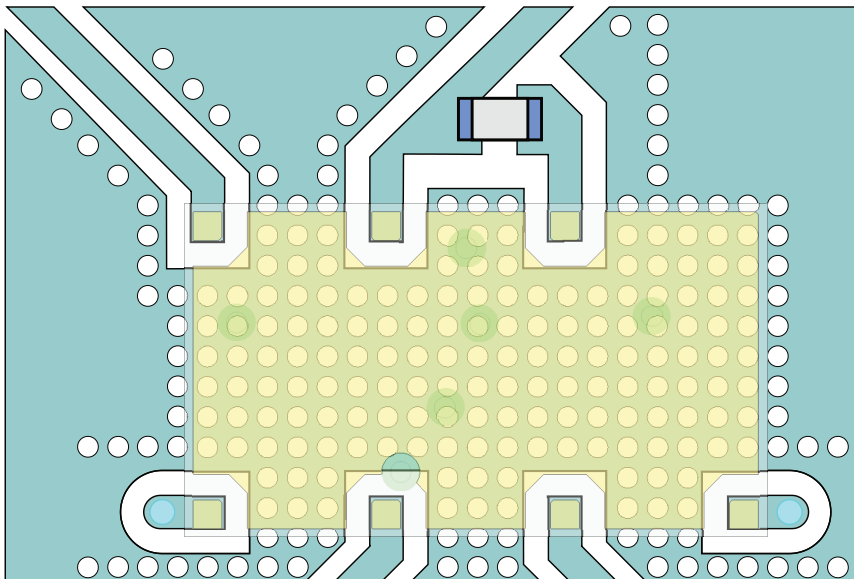
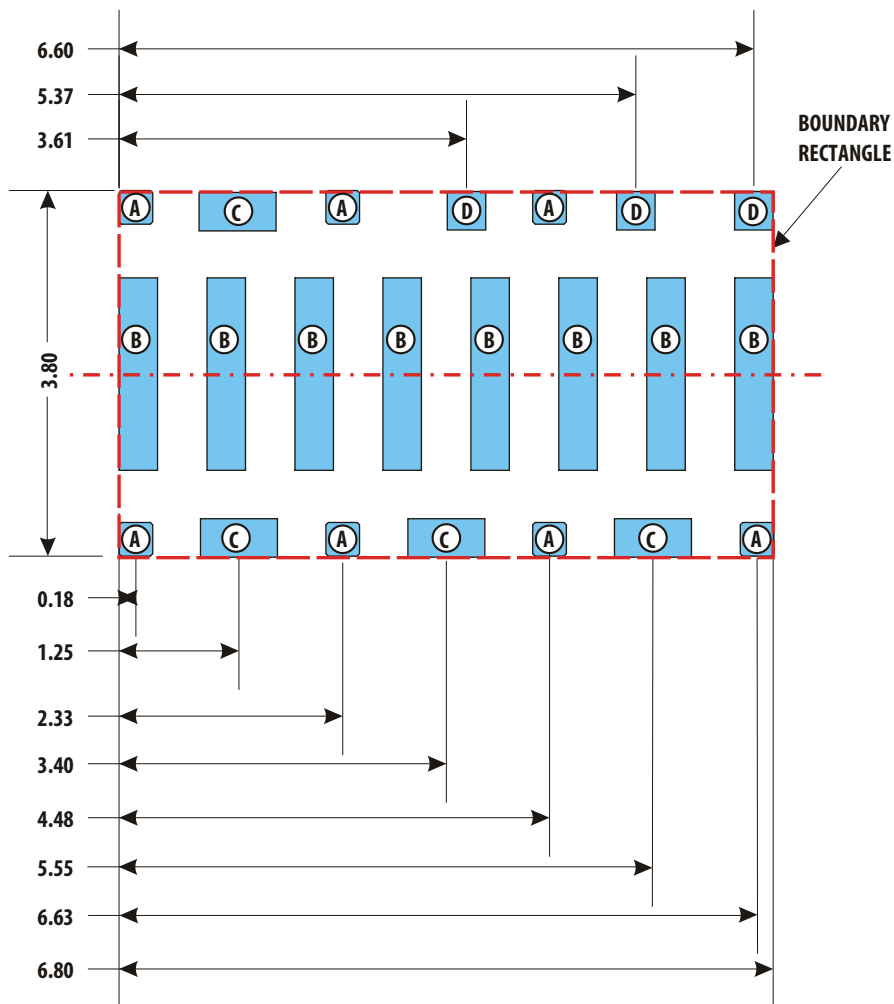

Figure 43. Suggested PCB Land Pattern for Single Antenna Connection (top view).

Notes:

1. Dimensions and detail follow same general schema as Figure 41.
2. Includes provision for 0402 size matching inductor to connect Ant-1 and Ant-2.
3. Suggested I/O connections for Cell-Rx, and PCS-Tx are preferably located on a buried metal layer to maintain best isolation.



Notes:

1. Dimensions in mm
2. Openings aligned to either Boundary Rectangle or Center Line
3. Openings "B" are equally spaced horizontally. Ref: Spacing = 0.514

Stencil Opening ID	Qty	Width	Height
A (I/O pad areas)	7	0.35	0.35
B	8	0.40	2.00
C	4	0.80	0.40
D	3	0.40	0.40

Figure 46. Recommended Solder Stencil (top view).

The I/O pad openings ("A") in the recommended solder stencil are the same size as the I/O pad metal patterns on the ACFM-7103.

The stencil pattern for the large ground pad area is divided into smaller openings ("B" through "D") for the purpose of

reducing the volume of solder paste. The use of smaller apertures reduces risk of solder voiding as well as preventing the device from "floating" during reflow.

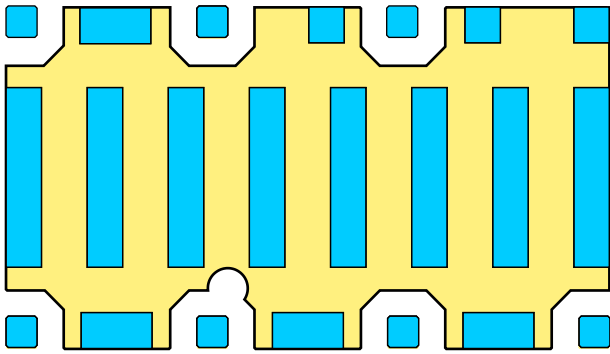

Figure 47. Solder Stencil Superposed on ACFM-7103 Bottom Metal Pattern. (top view)

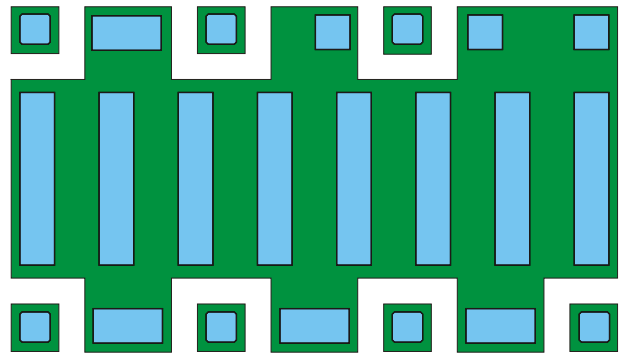

Figure 48. Solder Mask Superposed on Solder Stencil. (top view)

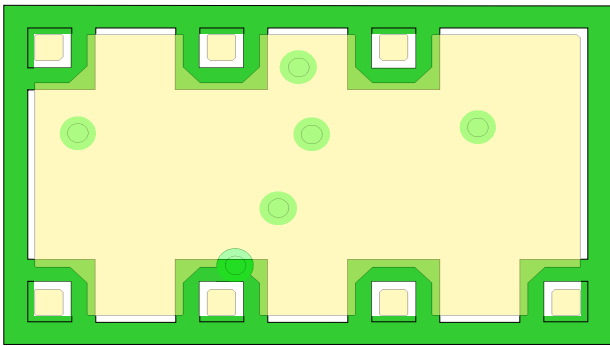

Figure 49. Solder Mask Superposed on ACFM-7103 Bottom Metal Pattern. (top view)

Package Moisture Sensitivity

Feature	Test Method	Performance
Moisture Sensitivity Level (MSL) at 260°C	J-STD-20C	Level 3

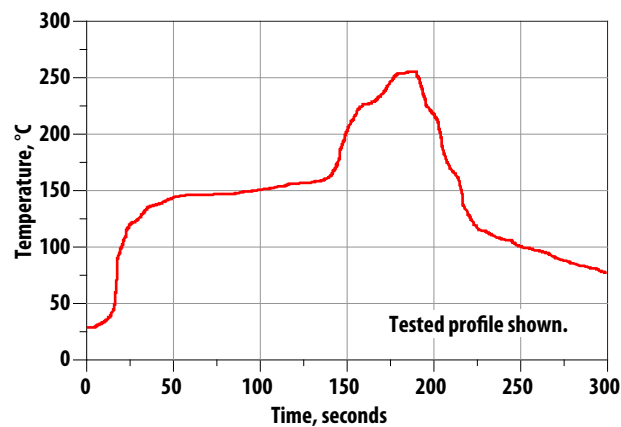

Figure 50. Verified SMT Solder Profile.

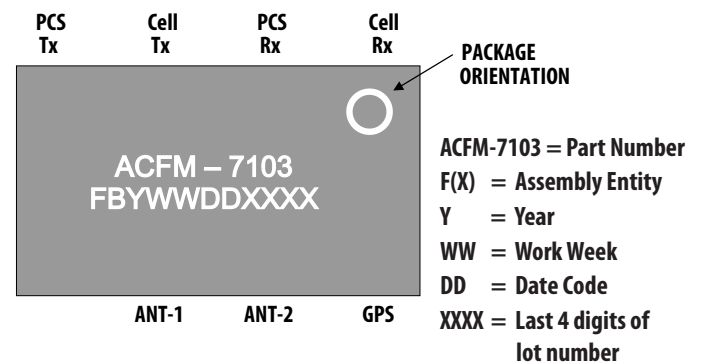

Figure 51. Package Marking

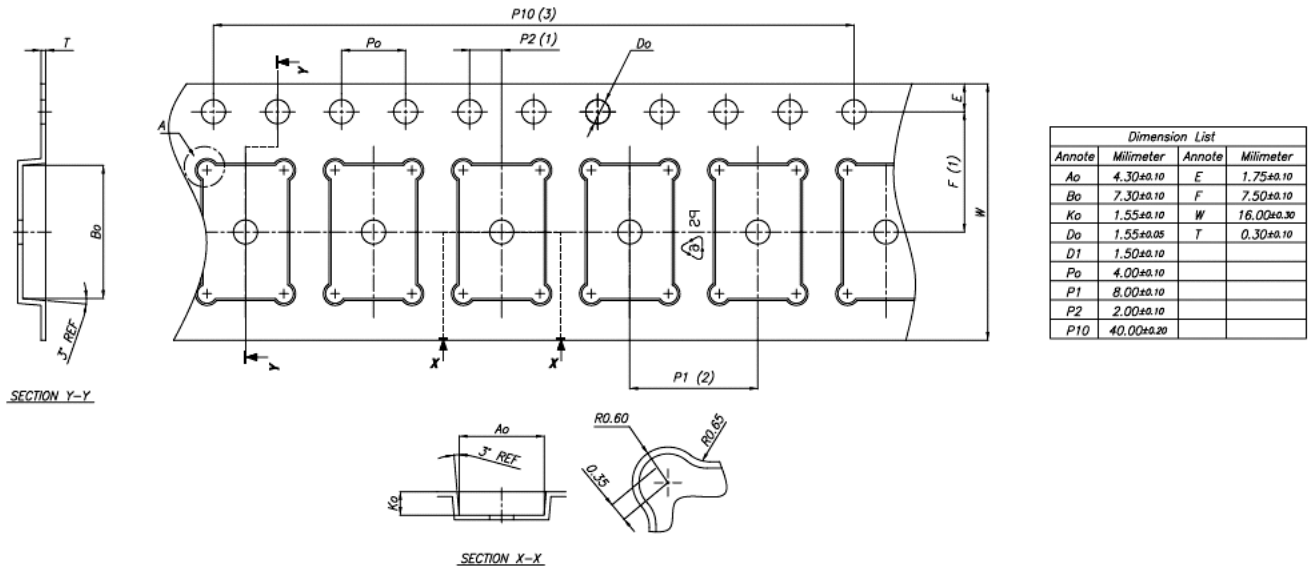

Figure 52. SMT Tape Packing

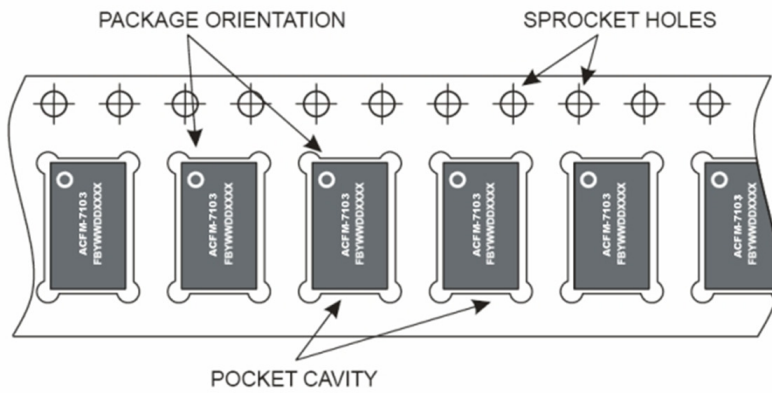
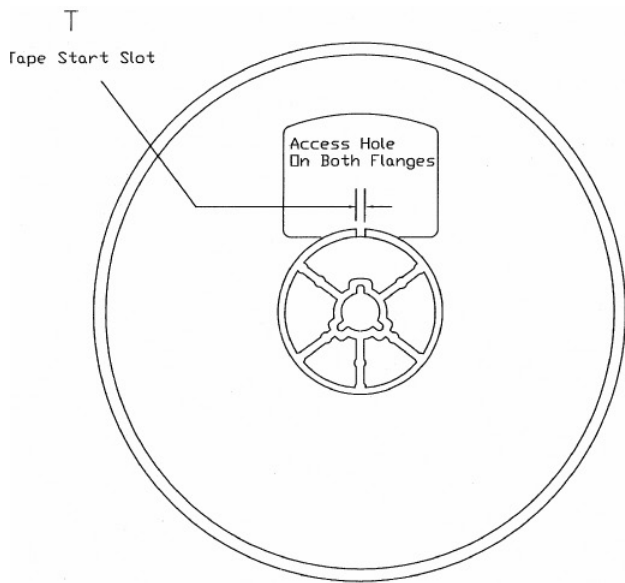
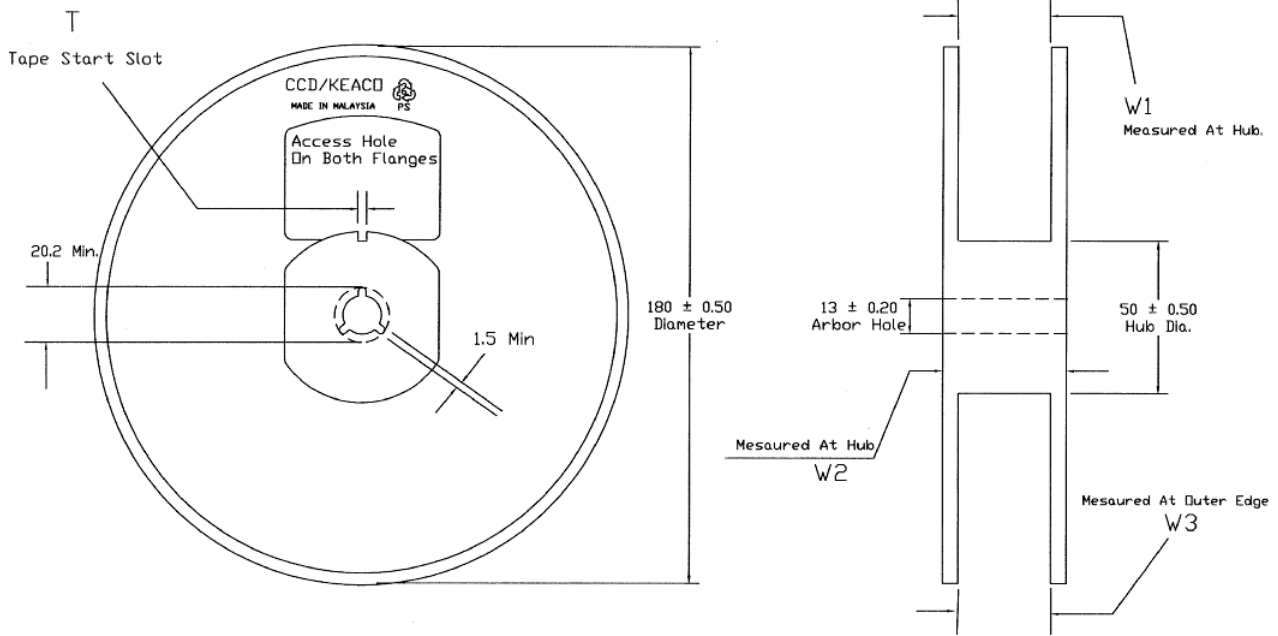

Figure 53. Orientation in Tape



- NOTE:
- 1. MATERIAL : POLYSTRENE
 - 2. SURFACE RESISTIVITY : < 10E12 OHMS/SQ
 - METHOD : ASTM D-257 AT 50% RH
 - 3. STATIC DECAY : < 2SEC. AT 50%RH

Figure 54. Reel Drawing

Ordering Information

Part Number	No. of Devices	Container
ACFM-7103-BLK	100	Anti-static Bag
ACFM-7103-TR1	3000	13-inch Reel

For product information and a complete list of distributors, please go to our web site: www.avagotech.com

Avago, Avago Technologies, and the A logo are trademarks of Avago Technologies in the United States and other countries. Data subject to change. Copyright © 2005-2009 Avago Technologies. All rights reserved. AV02-1455EN - August 20, 2009

