



Chipsmall Limited consists of a professional team with an average of over 10 year of expertise in the distribution of electronic components. Based in Hongkong, we have already established firm and mutual-benefit business relationships with customers from,Europe,America and south Asia,supplying obsolete and hard-to-find components to meet their specific needs.

With the principle of “Quality Parts,Customers Priority,Honest Operation,and Considerate Service”,our business mainly focus on the distribution of electronic components. Line cards we deal with include Microchip,ALPS,ROHM,Xilinx,Pulse,ON,Everlight and Freescale. Main products comprise IC,Modules,Potentiometer,IC Socket,Relay,Connector.Our parts cover such applications as commercial,industrial, and automotives areas.

We are looking forward to setting up business relationship with you and hope to provide you with the best service and solution. Let us make a better world for our industry!



## Contact us

Tel: +86-755-8981 8866 Fax: +86-755-8427 6832

Email & Skype: info@chipsmall.com Web: www.chipsmall.com

Address: A1208, Overseas Decoration Building, #122 Zhenhua RD., Futian, Shenzhen, China



## ACGRBT201-HF Thru. ACGRBT205-HF

Glass Passivated Type

Reverse Voltage: 200 to 1000 Volts

Forward Current: 2.0 Amp

RoHS Device

Halogen Free

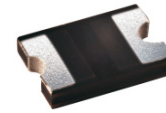

### Features

- Glass passivated cavity-free junction.
- Lead less chip form, no lead damage.
- Low forward voltage drop.
- Plastic package has UL 94V-0.
- Comply with AEC-Q101

### Mechanical data

- Case: Packed with FRP substrate and epoxy underfilled.
- Terminals: Pure Tin plated (Lead-Free), solderable per MIL-STD-750, method 2026.
- Polarity: Cathode Band, Laser marking.
- Weight: 0.04 grams (approx).

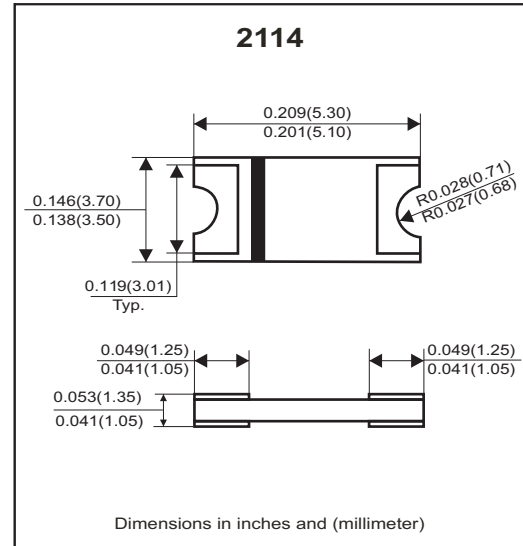

### Circuit Diagram



### Absolute Maximum Ratings (at Ta=25°C unless otherwise noted)

Parameter	Symbol	ACGRBT 201-HF	ACGRBT 202-HF	ACGRBT 203-HF	ACGRBT 204-HF	ACGRBT 205-HF	Units
Repetitive peak reverse voltage	$V_{RRM}$	200	400	600	800	1000	V
Peak forward surge current, 8.3ms single half sine-wave superimposed on rate load (JEDEC method)	$I_{FSM}$	50					A
Average forward current	$I_{F(AV)}$	2.0					A
Operating junction temperature	$T_J$	-65 to +175					°C
Storage temperature	$T_{STG}$	-65 to +175					°C

### Electrical Characteristics (at TA=25°C unless otherwise noted)

Parameter	Conditions	Symbol	MIN.	TYP.	MAX.	Unit
Forward voltage	$I_F = 2.0A$	$V_F$	-	0.96	1	V
Repetitive peak reverse current	$V_R = \text{Max. } V_{RRM}, T_A = 25^\circ C$	$I_{RRM}$	-	0.10	5	uA
Junction capacitance	$V_R = 4V, f = 1.0MHz$	$C_J$	-	14	-	pF
Thermal Resistance	Junction to ambient (Note)	$R_{\theta JA}$	-	66	-	°C/W
	Junction to lead (Note)	$R_{\theta JL}$	-	8	-	

Notes: Thermal resistance from junction to ambient and from junction to lead P.C.B. mounted on 0.2x0.2" (5.0x5.0mm) copper pad areas.

Company reserves the right to improve product design, functions and reliability without notice.

REV:B

## RATING AND CHARACTERISTIC CURVES (ACGRBT201-HF thru. ACGRBT205-HF)

FIG.1 - FORWARD CURRENT DERATING CURVE

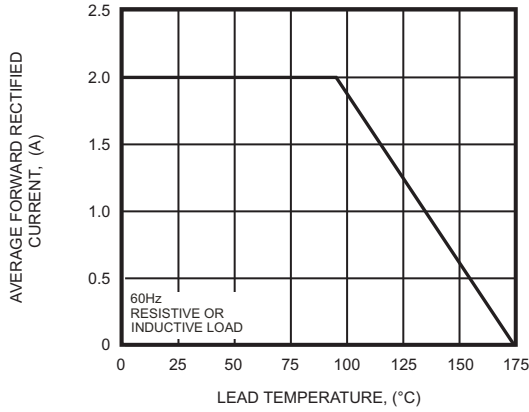

FIG.2 - MAXIMUM NON-REPETITIVE PEAK FORWARD SURGE CURRENT

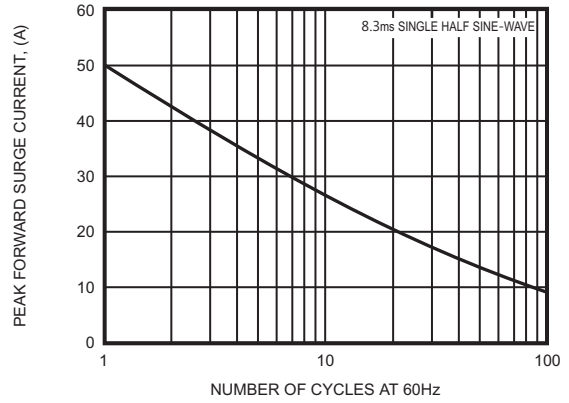

FIG.3 - TYPICAL INSTANTANEOUS FORWARD CHARACTERISTICS

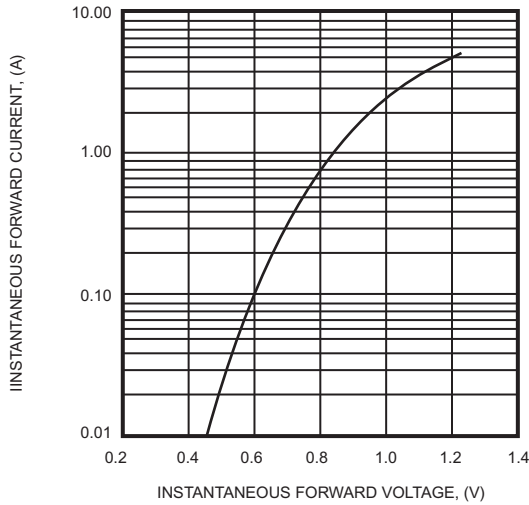

FIG.4 - TYPICAL REVERSE CHARACTERISTICS

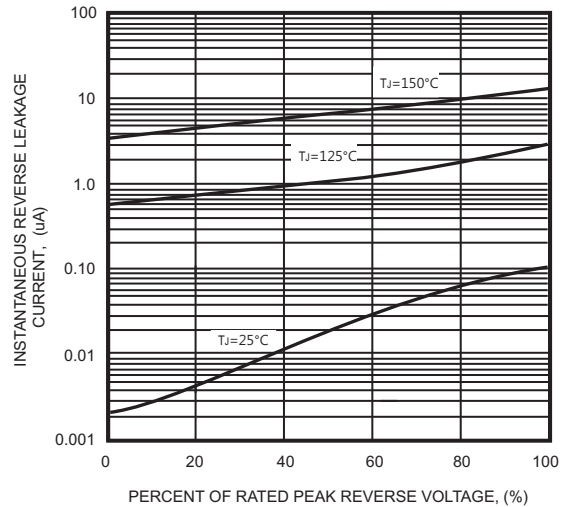
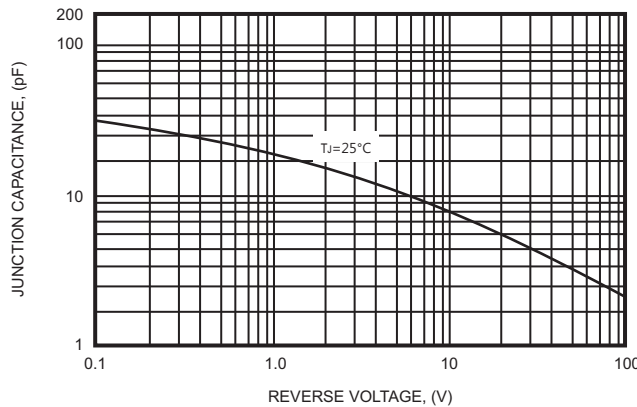
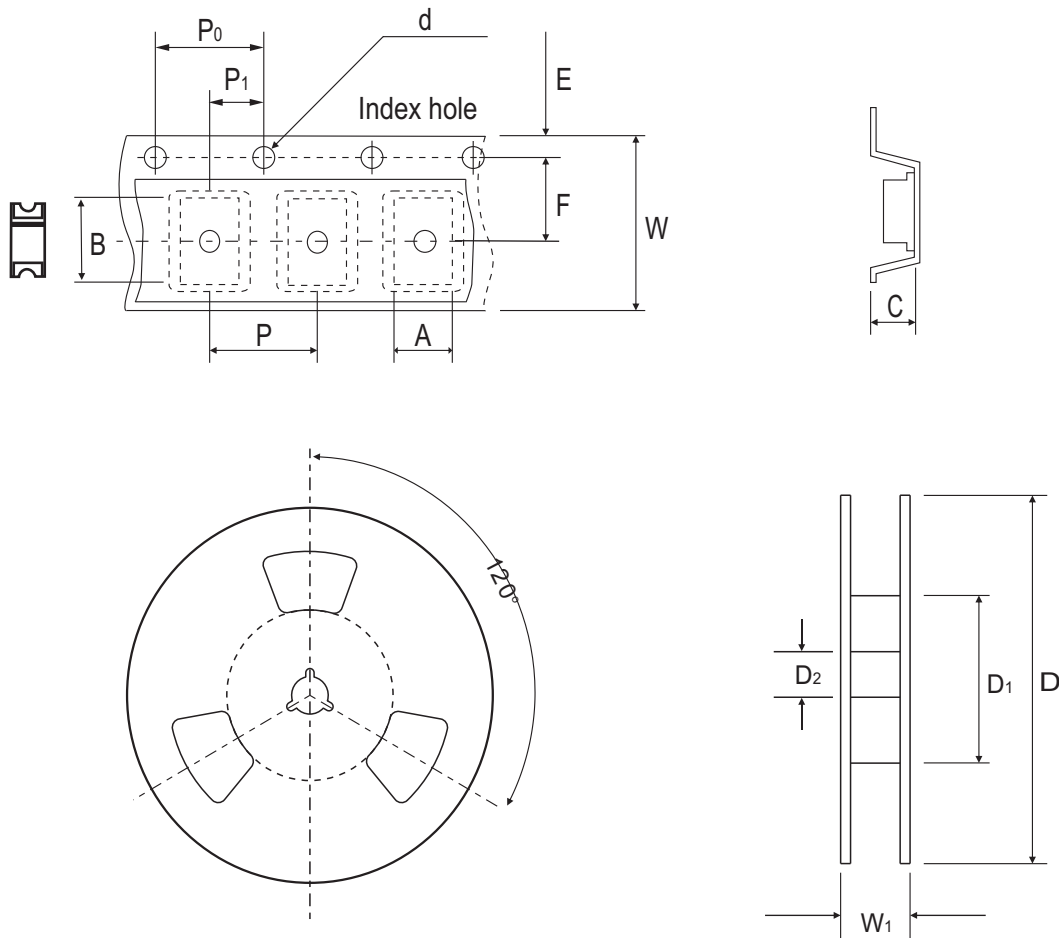

FIG.5 - TYPICAL JUNCTION CAPACITANCE



## Reel Taping Specification



2114	SYMBOL	A	B	C	d	D	D <sub>1</sub>	D <sub>2</sub>
	(mm)	3.95 ± 0.10	5.55 ± 0.10	1.45 ± 0.10	1.50 ± 0.10	330.00 ± 2.00	50.00 MIN.	13.00 ± 0.50
	(inch)	0.156 ± 0.004	0.219 ± 0.004	0.057 ± 0.004	0.059 ± 0.004	12.992 ± 0.079	1.969 MIN.	0.512 ± 0.020

2114	SYMBOL	E	F	P	P <sub>0</sub>	P <sub>1</sub>	W	W <sub>1</sub>
	(mm)	1.75 ± 0.10	5.50 ± 0.05	8.00 ± 0.10	4.00 ± 0.10	2.00 ± 0.10	12.00 ± 0.30	18.70 MAX.
	(inch)	0.069 ± 0.004	0.217 ± 0.002	0.315 ± 0.004	0.157 ± 0.004	0.079 ± 0.004	0.472 ± 0.012	0.736 MAX.



## Marking Code

Part Number	Marking Code
ACGRBT201-HF	20D
ACGRBT202-HF	20G
ACGRBT203-HF	20J
ACGRBT204-HF	20K
ACGRBT205-HF	20M



**XXX = Product type marking code**

## Suggested PAD Layout

SIZE	2114	
	(mm)	(inch)
<b>A</b>	3.00MIN.	0.118MIN.
<b>B</b>	2.65MAX.	0.104MAX.
<b>C</b>	6.65REF.	0.262 REF.

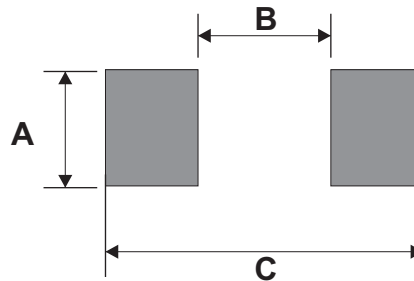

## Standard Packaging

Case Type	REEL PACK	
	REEL ( pcs )	Reel Size (inch)
2114	5,000	13