



Chipsmall Limited consists of a professional team with an average of over 10 year of expertise in the distribution of electronic components. Based in Hongkong, we have already established firm and mutual-benefit business relationships with customers from,Europe,America and south Asia,supplying obsolete and hard-to-find components to meet their specific needs.

With the principle of "Quality Parts,Customers Priority,Honest Operation,and Considerate Service",our business mainly focus on the distribution of electronic components. Line cards we deal with include Microchip,ALPS,ROHM,Xilinx,Pulse,ON,Everlight and Freescale. Main products comprise IC,Modules,Potentiometer,IC Socket,Relay,Connector.Our parts cover such applications as commercial,industrial, and automotives areas.

We are looking forward to setting up business relationship with you and hope to provide you with the best service and solution. Let us make a better world for our industry!



Contact us

Tel: +86-755-8981 8866 Fax: +86-755-8427 6832

Email & Skype: info@chipsmall.com Web: www.chipsmall.com

Address: A1208, Overseas Decoration Building, #122 Zhenhua RD., Futian, Shenzhen, China



3-terminal Filters

For power line

ACH series

Type:	ACH32C	[1206 inch]*
	ACH3218	[1207 inch]
	ACH4518	[1807 inch]

* Dimensions Code [EIA]

Issue date: September 2011

- All specifications are subject to change without notice.
 - Conformity to RoHS Directive: This means that, in conformity with EU Directive 2002/95/EC, lead, cadmium, mercury, hexavalent chromium, and specific bromine-based flame retardants, PBB and PBDE, have not been used, except for exempted applications.
-

3-terminal Filters For Power Line

Conformity to RoHS Directive

ACH Series ACH32C

FEATURES

- These T-type EMC filters comprise ferrite beads and chip capacitors and are engineered to handle high current levels.
- The series offers even greater attenuation characteristics when used in a stable circuit on the ground.
- The ACH series is ideal for high-density circuit design, since the series is vertically mounted and does not require much mounting space.
- Because guarantee temperature range is -40 to $+125^{\circ}\text{C}$, it is possible to use in strict environmental condition.
- Available for reflow soldering.

APPLICATIONS

Home electronic equipment, (TVs, VCRs, CD players, DAT players, electric musical instruments, PCs, etc.), office automation equipment (computers, terminals, stand-alone word processors, fax machines, etc.), factory automation equipment (robots, numerical control devices, process controllers, etc.), automotive electronics (car navigation, ECU, etc.)

SHAPES AND DIMENSIONS/CIRCUIT DIAGRAM

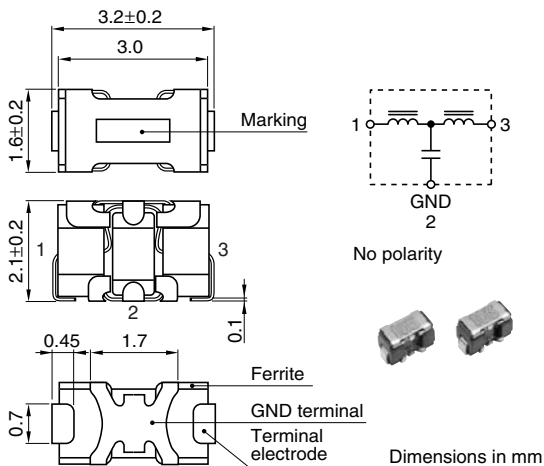

RECOMMENDED PC BOARD PATTERN REFLOW SOLDERING

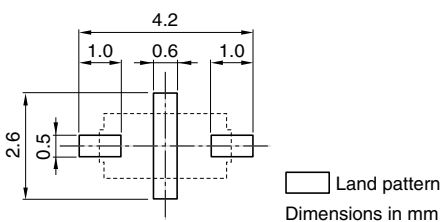

PRODUCT IDENTIFICATION

ACH 32C - 103 - T □□□
(1) (2) (3) (4) (5)

- (1) Series name
- (2) Dimensions
32C: 3216 type(3.2×1.6mm)
- (3) Capacitance
103: 10000pF
- (4) Packaging style
T: ϕ 180mm reel taping
- (5) TDK internal code

TEMPERATURE RANGES

Operating	-40 to $+125^{\circ}\text{C}$
Storage(After mount)	-40 to $+125^{\circ}\text{C}$

PACKAGING STYLE AND QUANTITIES

Packaging style	Reel	Quantity
Taping	ϕ 180mm	2000 pieces/reel

RECOMMENDED SOLDERING CONDITIONS

RECOMMENDED TEMPERATURE PROFILE FOR LEAD-FREE SOLDER

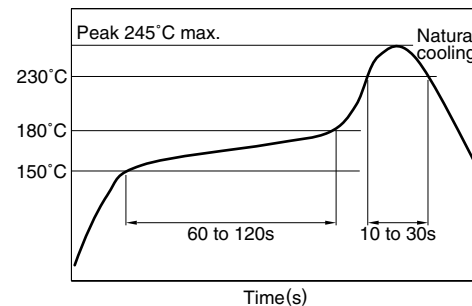

REFLOW PROFILE FOR SOLDER HEAT RESISTANCE

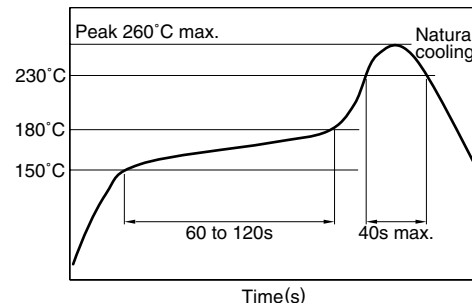

- Conformity to RoHS Directive: This means that, in conformity with EU Directive 2002/95/EC, lead, cadmium, mercury, hexavalent chromium, and specific bromine-based flame retardants, PBB and PBDE, have not been used, except for exempted applications.

- Please contact our Sales office when your application is considered the following:

The device's failure or malfunction may directly endanger human life (e.g. application for automobile/aircraft/medical/nuclear power devices, etc.)

- All specifications are subject to change without notice.

ELECTRICAL CHARACTERISTICS

Part No.	Rated voltage Edc(V)max.	Rated current (A)max.	Insulation resistance (M Ω)min.	DC resistance (m Ω)max.	Guaranteed attenuation (dB)	Guaranteed frequency bandwidth (MHz)
ACH32C-100-T001	50	6	100	2	-15	2000 to 6000
ACH32C-220-T001	50	6	100	2	-15	1300 to 2500
ACH32C-470-T001	50	6	100	2	-15	650 to 2500
ACH32C-101-T001	50	6	100	2	-20	450 to 1300
ACH32C-331-T001	50	6	100	2	-20	200 to 800
ACH32C-102-T001	50	6	100	2	-25	100 to 350
ACH32C-222-T001	50	6	100	2	-25	55 to 300
ACH32C-103-T001	50	6	100	2	-25	30 to 200
ACH32C-333-T001	50	6	100	2	-25	10 to 300
ACH32C-104-T001	50	6	100	2	-25	3.5 to 200

TYPICAL ELECTRICAL CHARACTERISTICS

ATTENUATION vs. FREQUENCY CHARACTERISTICS

(Glass epoxy coated double side mounting PCB)

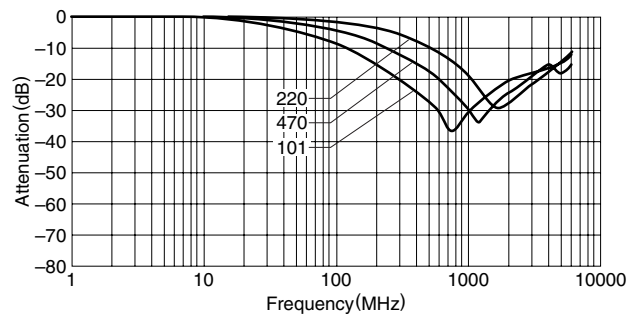
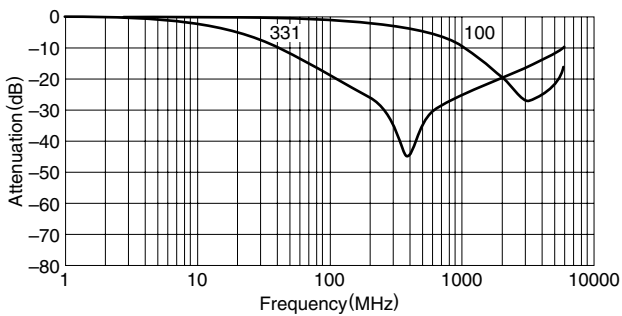
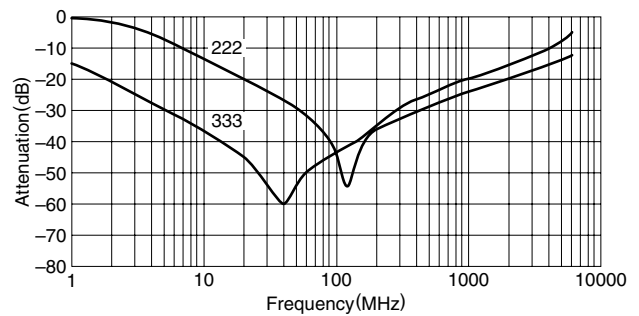
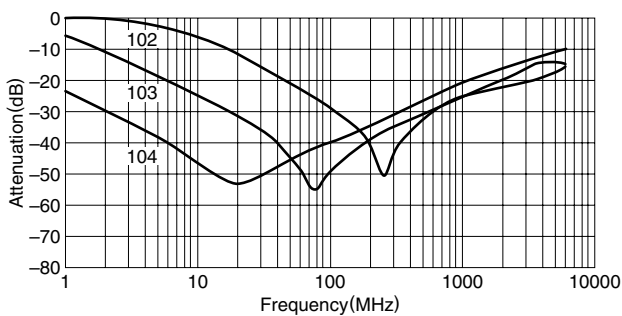

CIRCUIT DIAGRAM

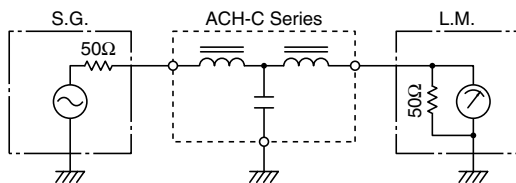

3-terminal Filters For Power Line

Conformity to RoHS Directive

ACH Series ACH3218, ACH4518

FEATURES

- The ACH series consists of products with superior attenuation characteristics, in which the T-type filter circuit is magnetically shielded with ferrite.
- The series offers even greater attenuation characteristics when used in a stable circuit on the ground.
- The ACH series is ideal for high-density circuit design, since the series is vertically mounted and does not require much mounting space.
- Available for reflow soldering.
- It is a product conforming to RoHS directive.

PRODUCT IDENTIFICATION

ACH	3218	-	223	-	T	D	□	□
(1)	(2)	(3)	(4)	(5)				

- (1) Series name
 (2) Dimensions
 (3) Type
 (4) Packaging style
 (5) TDK internal code

TEMPERATURE RANGES

Operating	-40 to +125°C
Storage(After mount)	-40 to +125°C

PACKAGING STYLE AND QUANTITIES

Packaging style	Quantity
Taping	1000 pieces/reel

HANDLING AND PRECAUTIONS

- Before soldering, be sure to preheat components. The preheating temperature should be set so that the temperature difference between the solder temperature and product temperature does not exceed 150°C.
- After mounting components onto the printed circuit board, do not apply stress through board bending or mishandling.
- The inductance value may change due to magnetic saturation if the current exceeds the rated maximum.
- Do not expose the inductors to stray magnetic fields.
- Avoid static electricity discharge during handling.
- When hand soldering, apply the soldering iron to the printed circuit board only. Temperature of the iron tip should not exceed 350°C. Soldering time should not exceed 3 seconds.

• Conformity to RoHS Directive: This means that, in conformity with EU Directive 2002/95/EC, lead, cadmium, mercury, hexavalent chromium, and specific bromine-based flame retardants, PBB and PBDE, have not been used, except for exempted applications.

• Please contact our Sales office when your application is considered the following:
 The device's failure or malfunction may directly endanger human life (e.g. application for automobile/aircraft/medical/nuclear power devices, etc.)

• All specifications are subject to change without notice.

ACH3218 TYPE SHAPES AND DIMENSIONS/CIRCUIT DIAGRAM

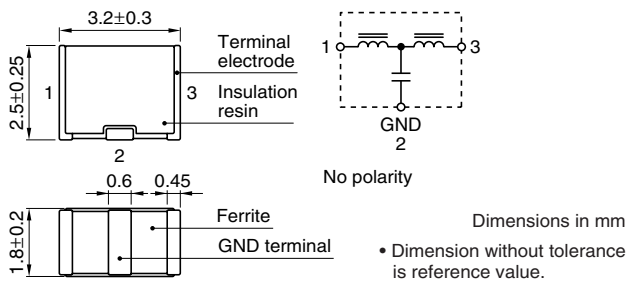

RECOMMENDED PC BOARD PATTERN REFLOW SOLDERING

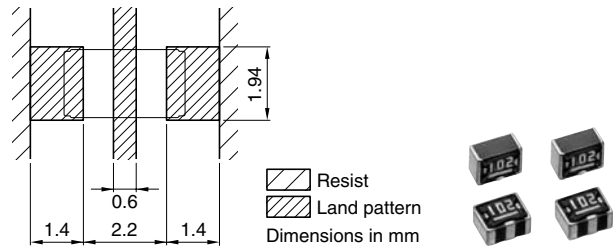

ELECTRICAL CHARACTERISTICS

Part No.	25dB attenuation frequency range (MHz)	Rated voltage Edc (V)max.	Rated current (A)max.	DC resistance (Ω)max. [Terminal No.1 to 3]	Insulation resistance (M Ω)min. [Terminal No.1 to 2/No.2 to 3]
ACH3218-223	11 to 55	20	1.5	0.06	1000
ACH3218-103	17 to 60	20	1.5	0.06	1000
ACH3218-682	22 to 75	20	1.5	0.06	1000
ACH3218-472	30 to 85	20	1.5	0.06	1000
ACH3218-332	37 to 90	20	1.5	0.06	1000
ACH3218-222	45 to 105	20	1.5	0.06	1000
ACH3218-152	60 to 115	20	1.5	0.06	1000
ACH3218-102	80 to 140	20	1.5	0.06	1000
ACH3218-681	95 to 150	20	1.5	0.06	1000
ACH3218-471	120 to 180	20	1.5	0.06	1000
ACH3218-331	130 to 210	20	1.5	0.06	1000
ACH3218-221	170 to 250	20	1.5	0.06	1000
ACH3218-151	205 to 280	20	1.5	0.06	1000
ACH3218-101	265 to 340	20	1.5	0.06	1000
ACH3218-680	340 to 420	20	1.5	0.06	1000
ACH3218-470	420 to 500	20	1.5	0.06	1000
ACH3218-330	500 to 600	20	1.5	0.06	1000
ACH3218-220	600 to 700	20	1.5	0.06	1000

TYPICAL ELECTRICAL CHARACTERISTICS ATTENUATION vs. FREQUENCY CHARACTERISTICS

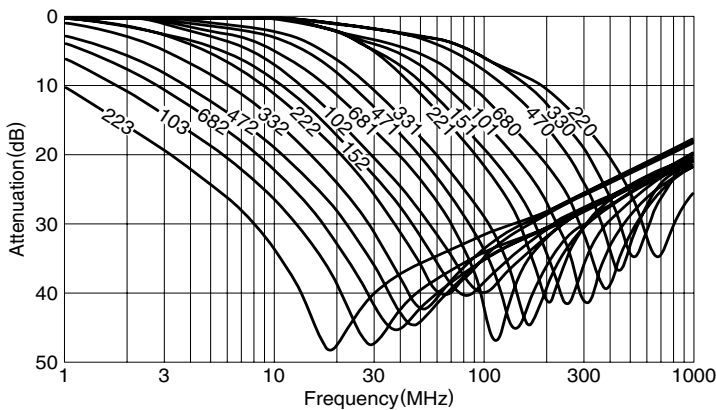

MEASURING CIRCUIT

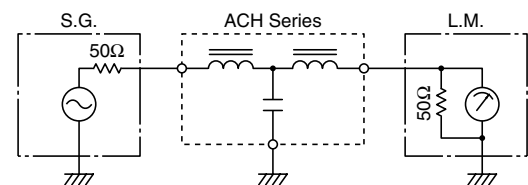

ACH4518 TYPE

SHAPES AND DIMENSIONS/CIRCUIT DIAGRAM

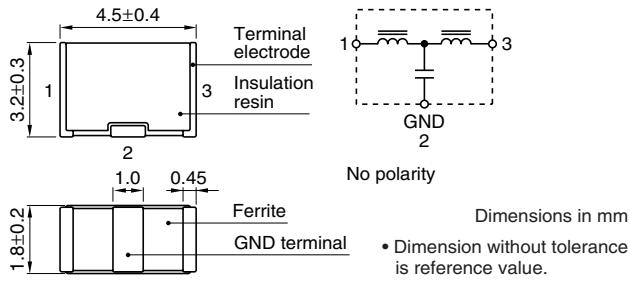

RECOMMENDED PC BOARD PATTERN REFLOW SOLDERING

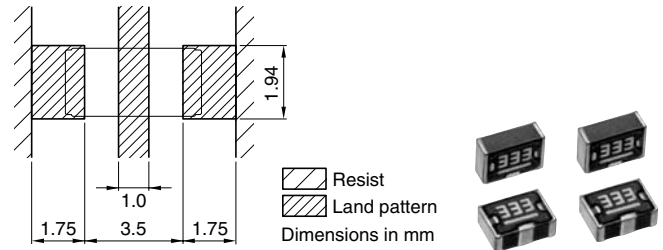

ELECTRICAL CHARACTERISTICS

Part No.	25dB attenuation frequency range (MHz)	Rated voltage Edc (V)max.	Rated current (A)max.	DC resistance (Ω)max. [Terminal No.1 to 3]	Insulation resistance (M Ω)min. [Terminal No.1 to 2/No.2 to 3]
ACH4518-333	6 to 60	50	2.0	0.06	1000
ACH4518-223	9 to 65	50	2.0	0.06	1000
ACH4518-153	11 to 70	50	2.0	0.06	1000
ACH4518-103	15 to 75	50	2.0	0.06	1000
ACH4518-682	20 to 85	50	2.0	0.06	1000
ACH4518-472	25 to 90	50	2.0	0.06	1000
ACH4518-332	35 to 100	50	2.0	0.06	1000
ACH4518-222	40 to 110	50	2.0	0.06	1000
ACH4518-152	50 to 130	50	2.0	0.06	1000
ACH4518-102	65 to 150	50	2.0	0.06	1000
ACH4518-681	75 to 160	50	2.0	0.06	1000
ACH4518-471	95 to 180	50	2.0	0.06	1000
ACH4518-331	115 to 205	50	2.0	0.06	1000
ACH4518-221	150 to 250	50	2.0	0.06	1000
ACH4518-151	190 to 290	50	2.0	0.06	1000
ACH4518-101	235 to 335	50	2.0	0.06	1000
ACH4518-680	290 to 395	50	2.0	0.06	1000
ACH4518-470	360 to 460	50	2.0	0.06	1000
ACH4518-330	450 to 550	50	2.0	0.06	1000
ACH4518-220	530 to 650	50	2.0	0.06	1000

TYPICAL ELECTRICAL CHARACTERISTICS

ATTENUATION vs. FREQUENCY CHARACTERISTICS

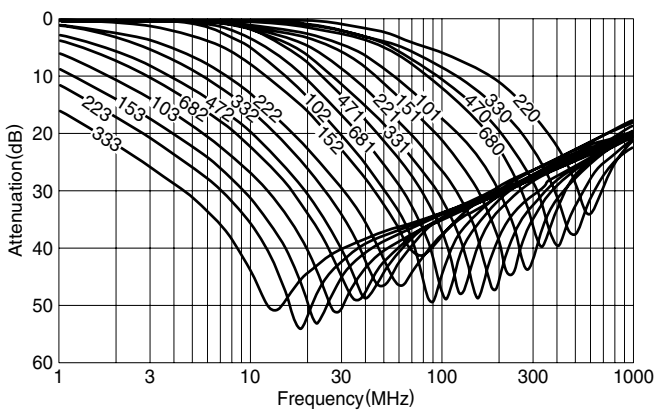

MEASURING CIRCUIT

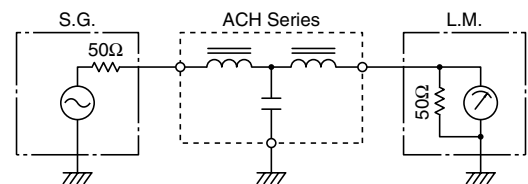

PACKAGING STYLES REEL DIMENSIONS

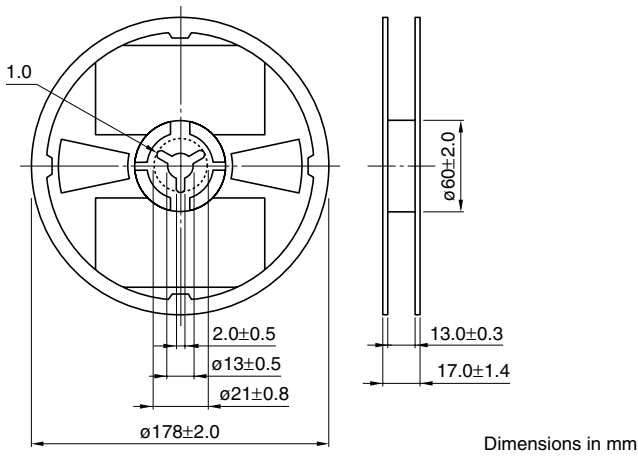

TAPE DIMENSIONS

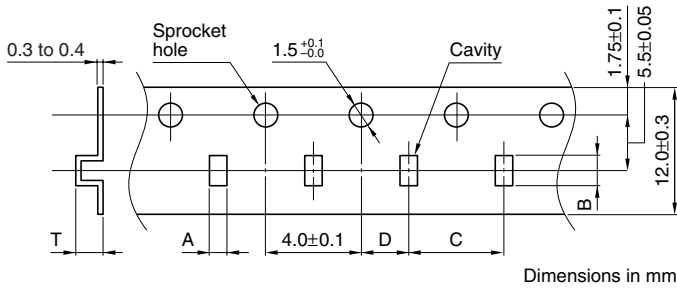

Type	A	B	C	D	T
321825	2.2 ± 0.2	3.7 ± 0.2	4.0 ± 0.1	2.0 ± 0.05	3.3max.
451832	2.2 ± 0.2	5.2 ± 0.2	4.0 ± 0.1	2.0 ± 0.05	3.8max.

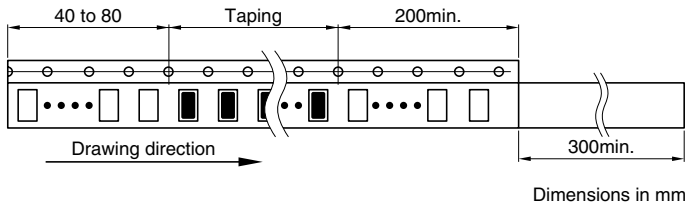

• All specifications are subject to change without notice.