



Chipsmall Limited consists of a professional team with an average of over 10 year of expertise in the distribution of electronic components. Based in Hongkong, we have already established firm and mutual-benefit business relationships with customers from,Europe,America and south Asia,supplying obsolete and hard-to-find components to meet their specific needs.

With the principle of “Quality Parts,Customers Priority,Honest Operation,and Considerate Service”,our business mainly focus on the distribution of electronic components. Line cards we deal with include Microchip,ALPS,ROHM,Xilinx,Pulse,ON,Everlight and Freescale. Main products comprise IC,Modules,Potentiometer,IC Socket,Relay,Connector.Our parts cover such applications as commercial,industrial, and automotives areas.

We are looking forward to setting up business relationship with you and hope to provide you with the best service and solution. Let us make a better world for our industry!



Contact us

Tel: +86-755-8981 8866 Fax: +86-755-8427 6832

Email & Skype: info@chipsmall.com Web: www.chipsmall.com

Address: A1208, Overseas Decoration Building, #122 Zhenhua RD., Futian, Shenzhen, China



ACMD-6125

Band 25 Duplexer



Data Sheet

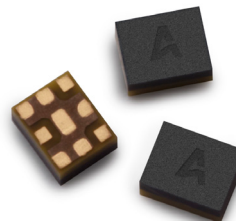

Description

The Avago ACMD-6125 is a highly miniaturized duplexer designed for use in Band 25 (1850.25 – 1914.75 MHz UL, 1930.25 – 1994.75 MHz DL) handsets and mobile data terminals.

Low Insertion Loss in the Tx channel minimizes current drain from the power amplifier, while low Rx channel Insertion Loss improves receiver sensitivity.

The ACMD-6125 enhances the sensitivity and dynamic range of handset receivers by providing high isolation of the transmitted signal from the receiver input and high rejection of transmit-generated noise in the receive band.

The ACMD-6125 is designed with Avago Technologies' innovative Film Bulk Acoustic Resonator (FBAR) technology, which makes possible ultra-small, high-Q filters at a fraction of their usual size. The excellent power handling capability of FBAR bulk-mode resonators supports the high output power levels used in mobile communications applications, while adding virtually no distortion.

The ACMD-6125 also utilizes Avago's advanced Microcap bonded-wafer, chip scale packaging technology. This process allows the filters to be assembled into a molded chip-on-board module with an overall size of only 1.6 x 2.0 mm and height of 0.9 mm. The ACMD-6125 is compatible with standard 1.6 x 2.0 mm duplexer PCB footprints.

Functional Block Diagram

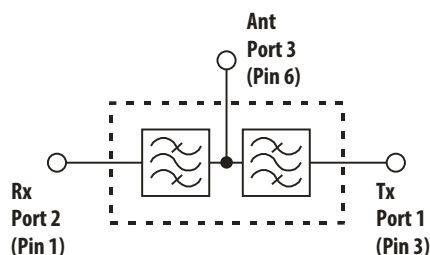

Features

- Miniature Size
 - 1.6 x 2.0 mm size
 - 0.9 mm height
 - Standard 1.6 x 2.0 mm PCB footprint
- High Isolation
- High Power Rating
 - +33 dBm Abs Max. Tx Power
- Environmental
 - RoHS Compliant
 - Halogen free
 - TBBPA Free

Specifications, -10 °C to +85 °C

- Rx Band Performance
 - Insertion Loss: 3.8 dB Max.
 - Rx Noise Blocking: 45 dB Min.
- Tx Band Performance
 - Insertion Loss: 4.0 dB Max.
 - Tx Interferer Blocking: 50 dB Min.

Applications

Handsets or data terminals operating in the Band 25 frequency range.

ACMD-6125 Electrical Specifications ^[2], $Z_0=50\ \Omega$, T_c ^[1] as indicated.

Symbol	Parameter	Units	-10°C		+25°C			+85°C	
			Min.	Max.	Min.	Typ. ^[3]	Max.	Min.	Max.
Antenna Port to Receive Port									
S23	Insertion Loss in Band 25 Rx Band ^[4] (1930.25 – 1994.75 MHz)	dB		3.8		1.6	3.5		3.5
S23	Insertion Loss in UMTS Band 2 Rx Band ^[5] (1930.48 – 1989.52 MHz)	dB		3.4		1.6	3.0		3.2
S23	Attenuation in Band 25 Tx Band (1850.25 – 1914.75 MHz)	dB	48		48	67		48	
S23	Attenuation, 80 MHz	dB	40		40	58		40	
S23	Attenuation in Band Class 10 Tx (817 – 849 MHz)	dB	35		35	41		35	
S23	Attenuation, 1770 – 1830 MHz	dB	40		40	48		40	
S23	Attenuation, 2400 – 2500 MHz	dB	40		40	55		40	
S23	Attenuation, 3780 – 3990 MHz	dB	40		40	54		40	
S23	Attenuation, 5630 – 5985 MHz	dB	40		40	47		40	
S23	Attenuation, 7720 – 7980 MHz	dB	30		30	59		30	
S22	Return Loss (SWR) of Rx Port in Rx Band (1930.5 – 1994.75 MHz)	dB	8	(2.3)	8	18 (1.3)	(2.3)	8	(2.3)
S33	Return Loss (SWR) of Ant Port in Rx Band (1930.5 – 1994.75 MHz)	dB	8	(2.3)	8	15 (1.4)	(2.3)	8	(2.3)
Transmit Port to Antenna Port									
S31	Insertion Loss in Band 25 Tx Band ^[4] (1850.25 – 1914.75 MHz)	dB		3.5		1.2	3.0		4.0
S31	Insertion Loss in UMTS Band 2 Tx Band ^[5] (1850.48 – 1909.52 MHz)	dB		3.1		1.2	2.7		2.7
S31	Attenuation in Band 25 Rx Band (1930.25 – 1994.75 MHz)	dB	40		44	70		44	
S31	Attenuation in Band Class 10 Rx (862 – 894 MHz)	dB	43		43	50		43	
S31	Attenuation in GPS/GLONASS Bands (1559 – 1606 MHz)	dB	43		43	48		43	
S31	Attenuation in AWS Rx Band (2110 – 2155 MHz)	dB	42		42	51		42	
S31	Attenuation in Bluetooth/ISM Bands (2400 – 2500 MHz)	dB	40		40	52		40	
S31	Attenuation in Tx 2nd Harmonic Band (3700 – 3830 MHz)	dB	30		30	48		30	
S31	Attenuation in Tx 3rd Harmonic Band (5550 – 5745 MHz)	dB	20		20	31		20	
S31	Attenuation in Tx 4th Harmonic Band (7400 – 7660 MHz)	dB	12		12	17		12	
S11	Return Loss (SWR) of Tx Port in Tx Band (1850.25 – 1914.75 MHz)	dB	9	(2.1)	9	18 (1.3)	(2.1)	9	(2.1)
S33	Return Loss (SWR) of Ant Port in Tx Band (1850.25 – 1914.75 MHz)	dB	9	(2.1)	9	13 (1.6)	(2.1)	9	(2.1)

Continued on next page...

ACMD-6125 Electrical Specifications^[2], $Z_0=50\ \Omega$, T_C ^[1] as indicated. (Cont.)

Symbol	Parameter	Units	-10°C		+25°C		+85°C	
			Min.	Max.	Min.	Typ. ^[3]	Max.	Min.
Isolation, Tx Port to Rx Port								
S21	Tx-Rx Isolation in Band 25 Rx Band ^[4] (1930.25 – 1931.25 MHz) (1931.25 – 1994.75 MHz)	dB	45 50		50 50	64 70		50 50
S21	Tx-Rx Isolation in UMTS Band 2 Rx Band ^[5] (1930.48 – 1989.52 MHz)	dB	50		50	70		50
S21	Tx-Rx Isolation in Band 25 Tx Band ^[4] (1850.25 – 1913.50 MHz) (1913.50 – 1914.75 MHz)	dB	55 55		55 55	67 67		55 50
S21	Tx-Rx Isolation in UMTS Band 2 Tx Band ^[5] (1850.48 – 1909.52 MHz)	dB	55		55	67		55

Notes:

1. T_C is the case temperature and is defined as the temperature of the underside of the Duplexer where it makes contact with the circuit board.
2. Min/Max specifications are guaranteed at the indicated temperature with the input power to the Tx port equal to or less than +27 dBm over all Tx frequencies unless otherwise noted.
3. Typical data is the average value of the parameter over the indicated band at the specified temperature. Typical values may vary over time.
4. Integrated Insertion Loss over any 1.25 MHz channel within the band.
5. Integrated Insertion Loss over any 3.84 MHz channel within the band.

Absolute Maximum Ratings^[1]

Parameter	Unit	Value
Storage temperature	°C	-65 to +125
Maximum RF Input Power to Tx Port	dBm	+33

Maximum Recommended Operating Conditions^[2]

Parameter	Unit	Value
Operating temperature, T_C ^[3] , Tx Power ≤ 29 dBm, CW	°C	-40 to +100
Operating temperature, T_C ^[3] , Tx Power ≤ 30 dBm, CW	°C	-40 to +85

Notes:

1. Operation in excess of any one of these conditions may result in permanent damage to the device.
2. The device will function over the recommended range without degradation in reliability or permanent change in performance, but is not guaranteed to meet electrical specifications.
3. T_C is defined as case temperature, the temperature of the underside of the duplexer where it makes contact with the circuit board.

ACMD-6125 Typical Performance at $T_c = 25^\circ\text{C}$

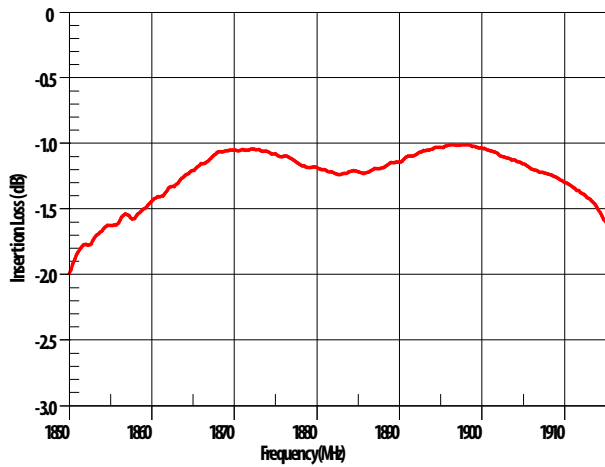

Figure 1. Tx-Ant Insertion Loss

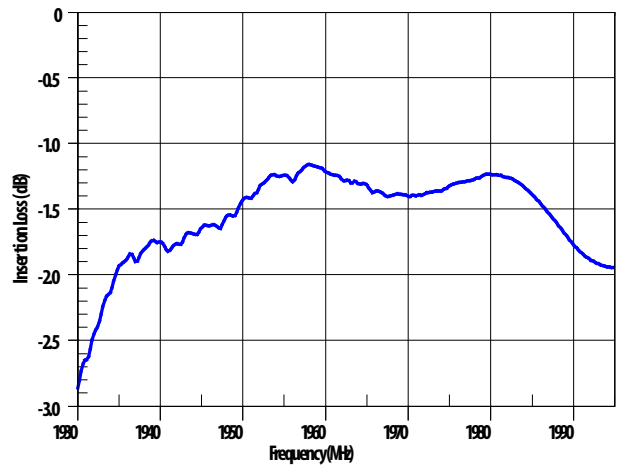

Figure 2. Ant-Rx Insertion Loss

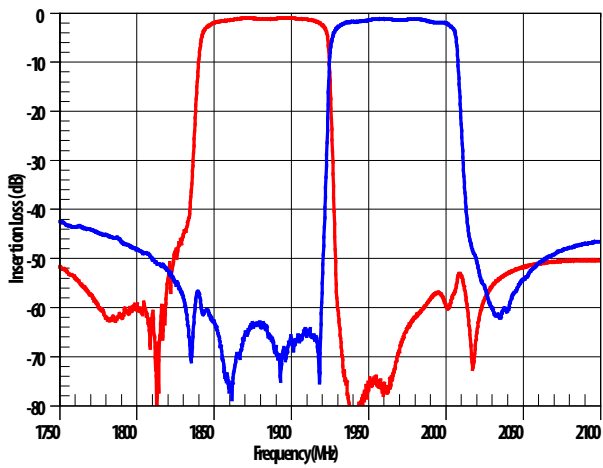

Figure 3. Tx Rejection in Rx Band and Rx Rejection in Tx Band

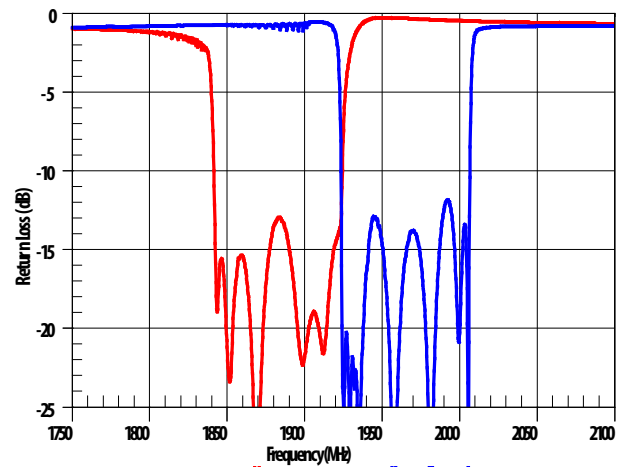

Figure 4. Tx and Rx Port Return Loss

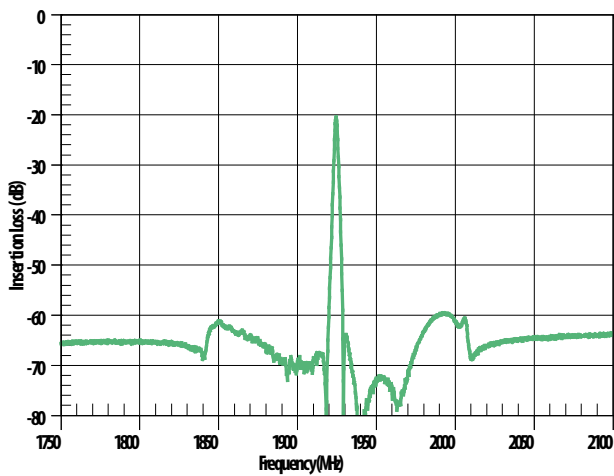

Figure 5. Tx-Rx Isolation

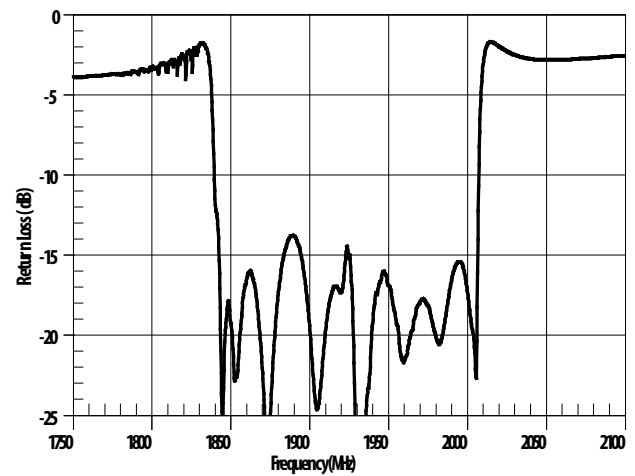

Figure 6. Antenna Port Return Loss

ACMD-6125 Typical Performance at $T_c = 25^\circ\text{C}$

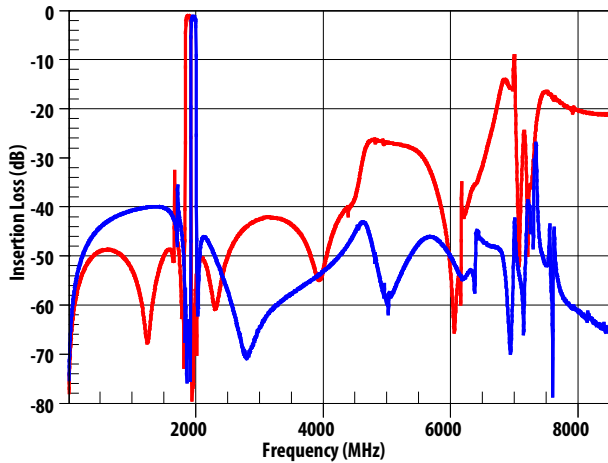

Figure 7. Tx-Ant and Ant-Rx Wideband Insertion Loss, 10 – 8500 MHz

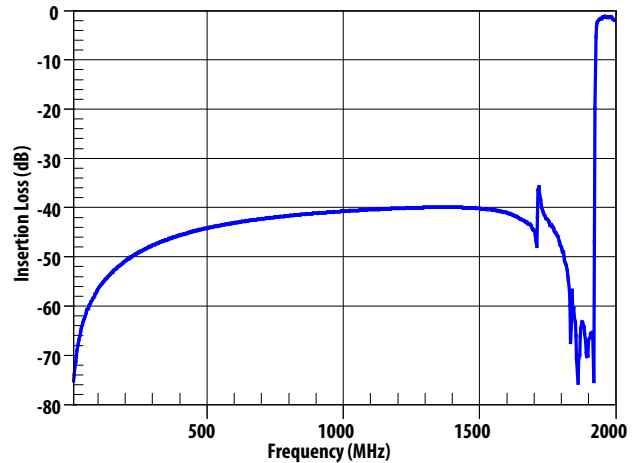

Figure 8. Ant-Rx Low Frequency Rejection

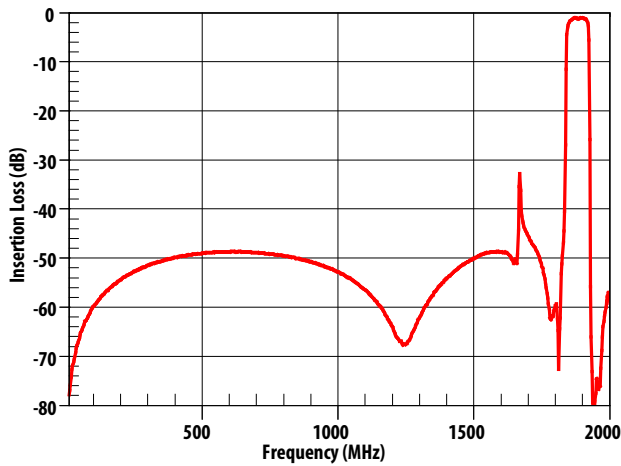

Figure 9. Tx-Ant Low Frequency Rejection

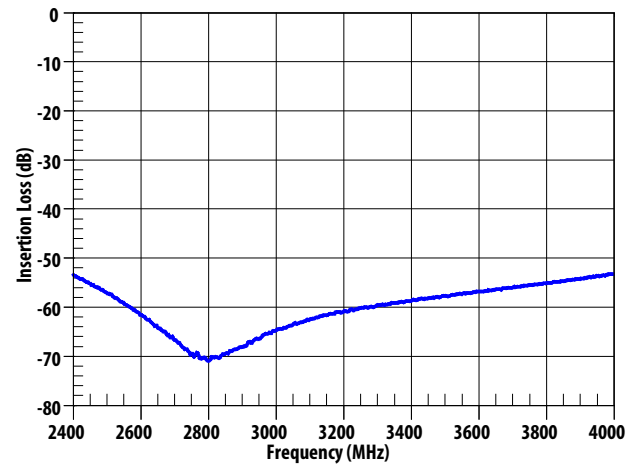

Figure 10. Ant-Rx Rejection, 2400 – 4000 MHz

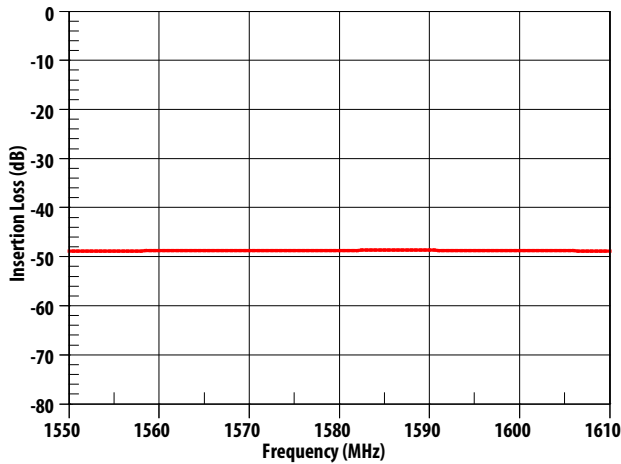

Figure 11. Tx-Ant Rejection in GPS/GLONASS Bands

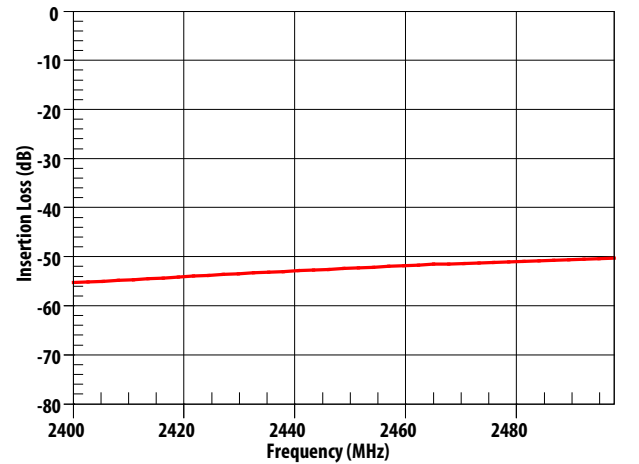

Figure 12. Ant-Tx Rejection in Bluetooth/ISM Bands

ACMD-6125 Typical Performance at $T_c = 25^\circ\text{C}$

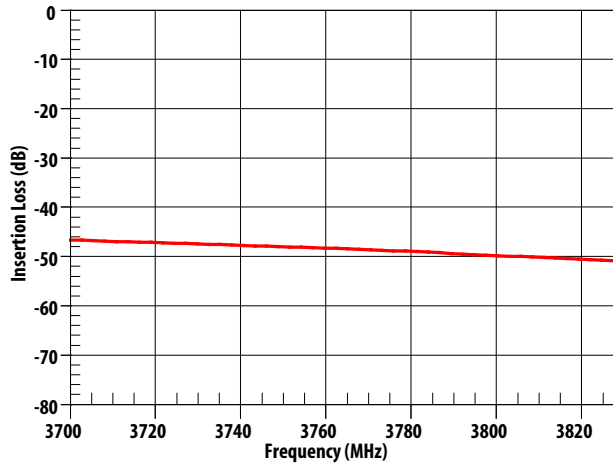

Figure 13. Tx-Ant Rejection at Tx Second Harmonic

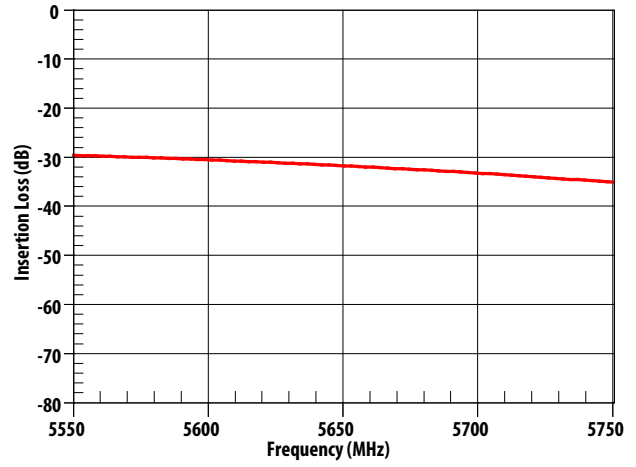

Figure 14. Tx-Ant Rejection at Tx Third Harmonic

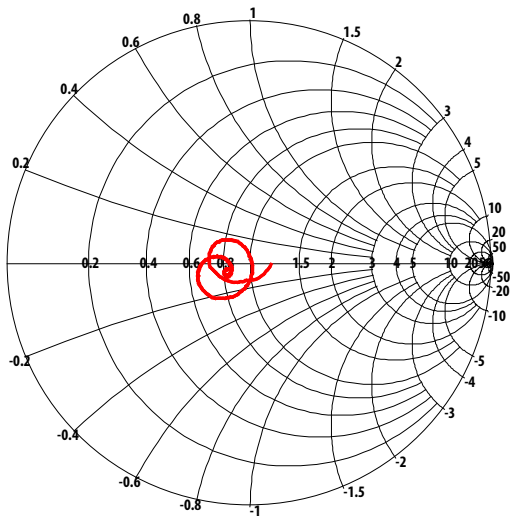

Figure 15. Tx Port Impedance in Tx Band

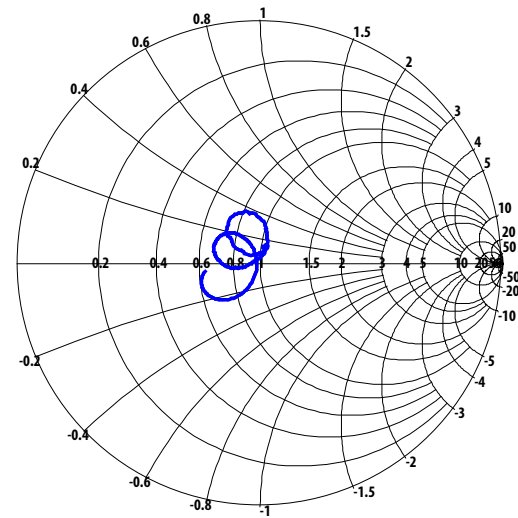

Figure 16. Rx Port Impedance in Rx Band

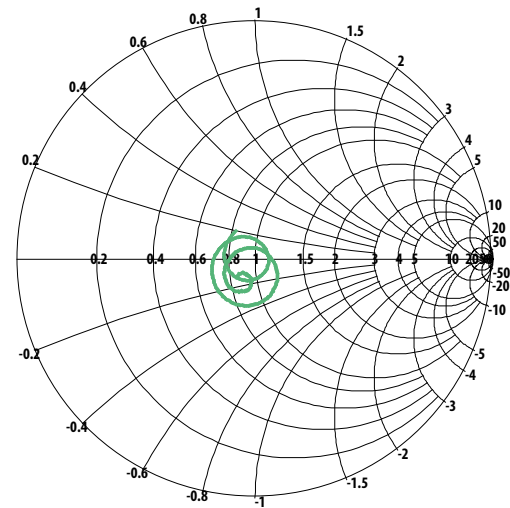

Figure 17. Ant Port Impedance in Tx Band

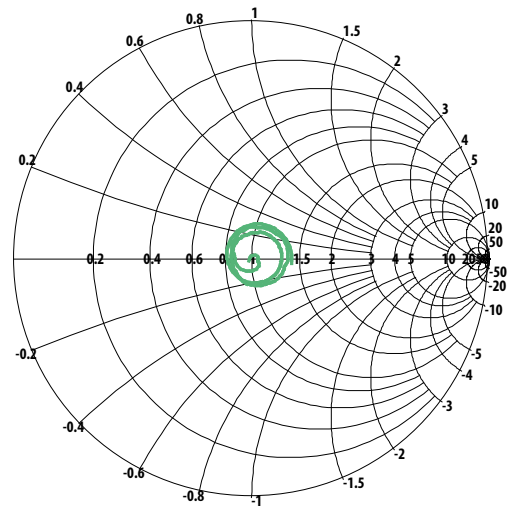

Figure 18. Ant Port Impedance in Rx Band

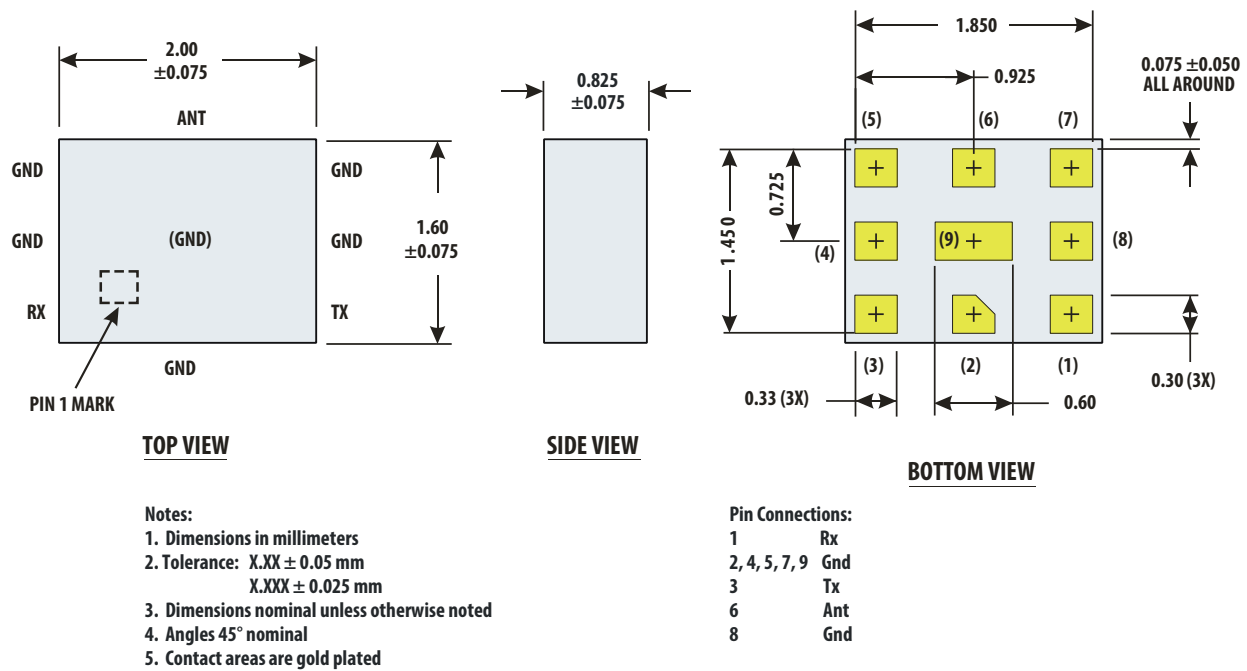

Figure 19. Package Outline Drawing

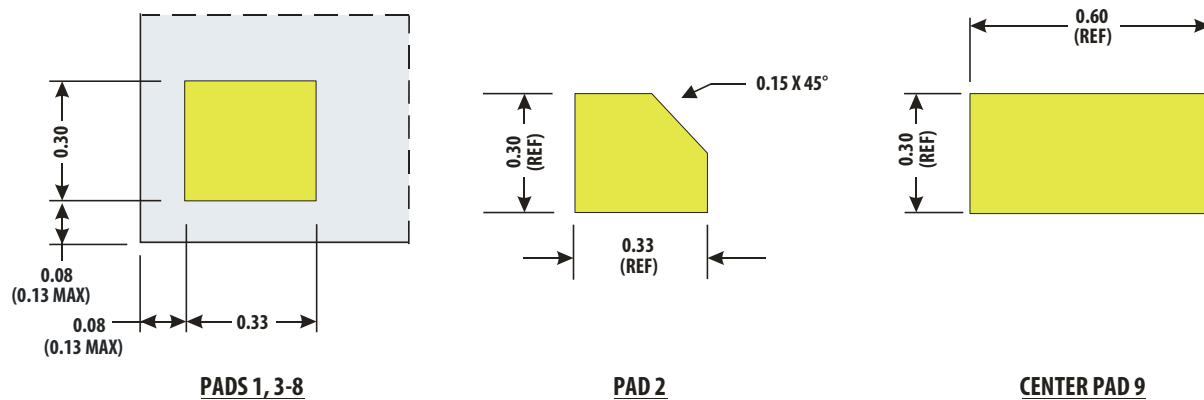

Figure 20. Pad Detail

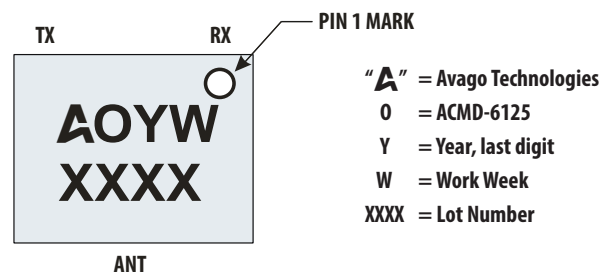

Figure 21. Product Marking and Pin Orientation

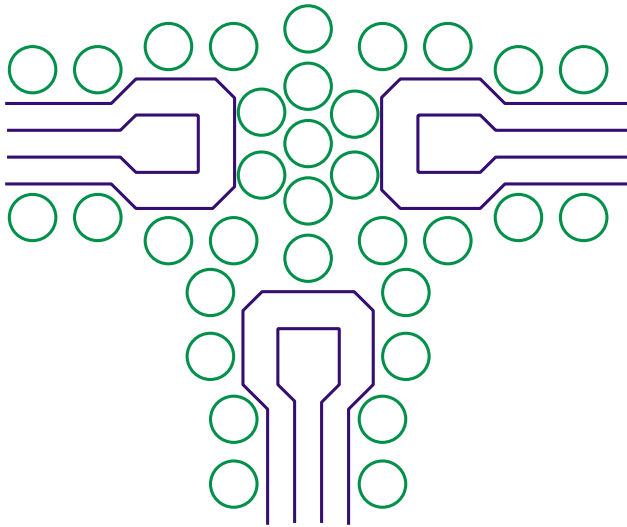

Figure 22. PCB Layout

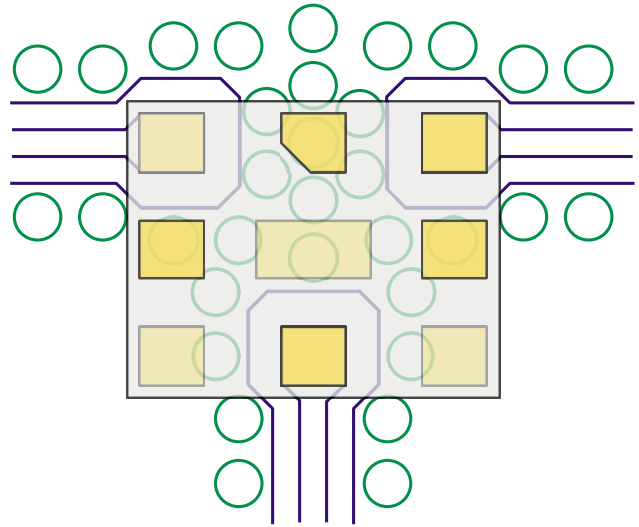

Figure 23. ACMD-6125 Superimposed on PCB Pattern

A circuit board layout using the principles illustrated in the figure above is recommended to optimize performance of the ACMD-6125.

You must maximize isolation between the Tx and Rx ports.

High isolation is achieved by: (1) maintaining a continuous ground plane around the I/O connections and duplexer mounting area, and (2) surrounding the I/O ports with sufficient ground vias to enclose the connections in a 'Faraday cage.'

The ground vias under the ACMD-6125 mounting area are also needed to provide adequate heat sinking for the device.

The 2nd metal layer under the duplexer is a continuous ground plane.

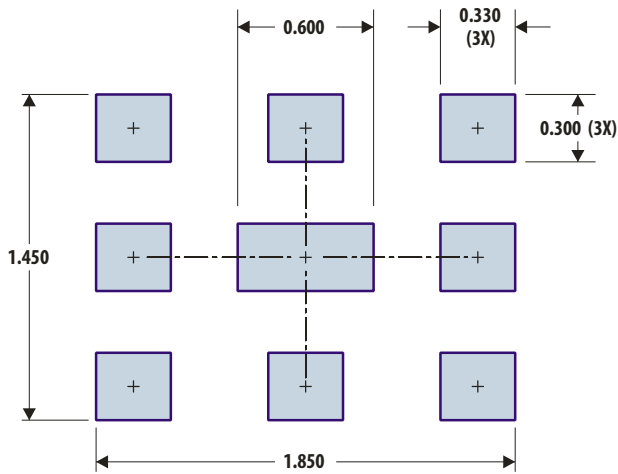

Notes:
1. Dimensions in mm

Figure 24. PCB Land Print

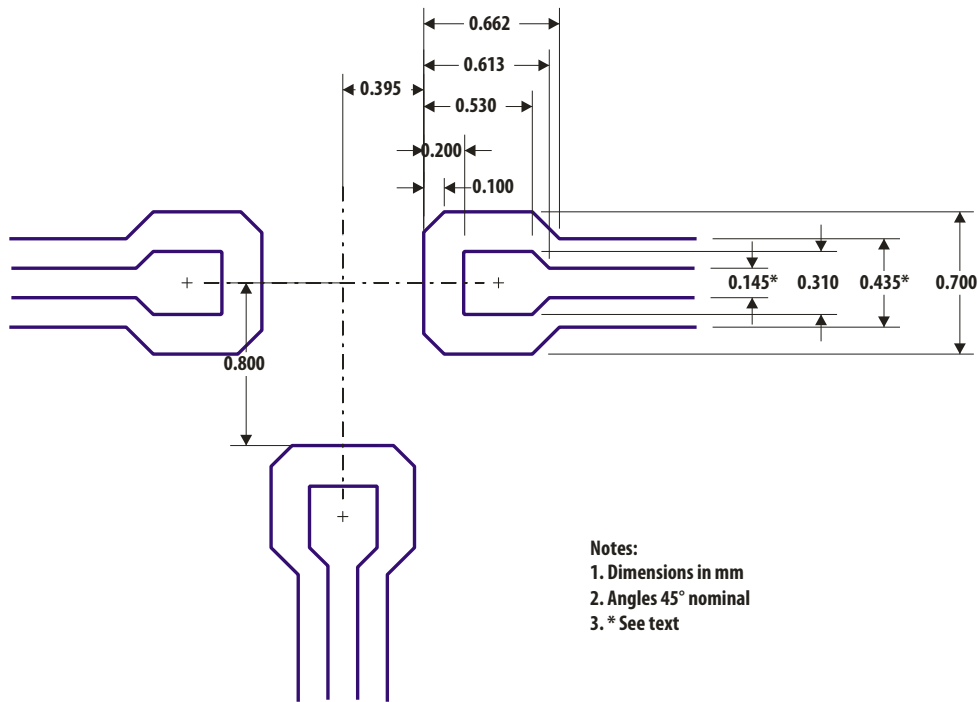

Figure 25. PCB Detail, Metal Dimensions

The transmission line dimensions shown are designed to achieve an impedance of 50Ω for a $75 \mu\text{m}$ thick PCB layer with a dielectric constant of 3.4. If other PCB materials or thicknesses are used, the two dimensions indicated with an "*" (line width and spacing) should be adjusted to retain a Z_0 of 50Ω .

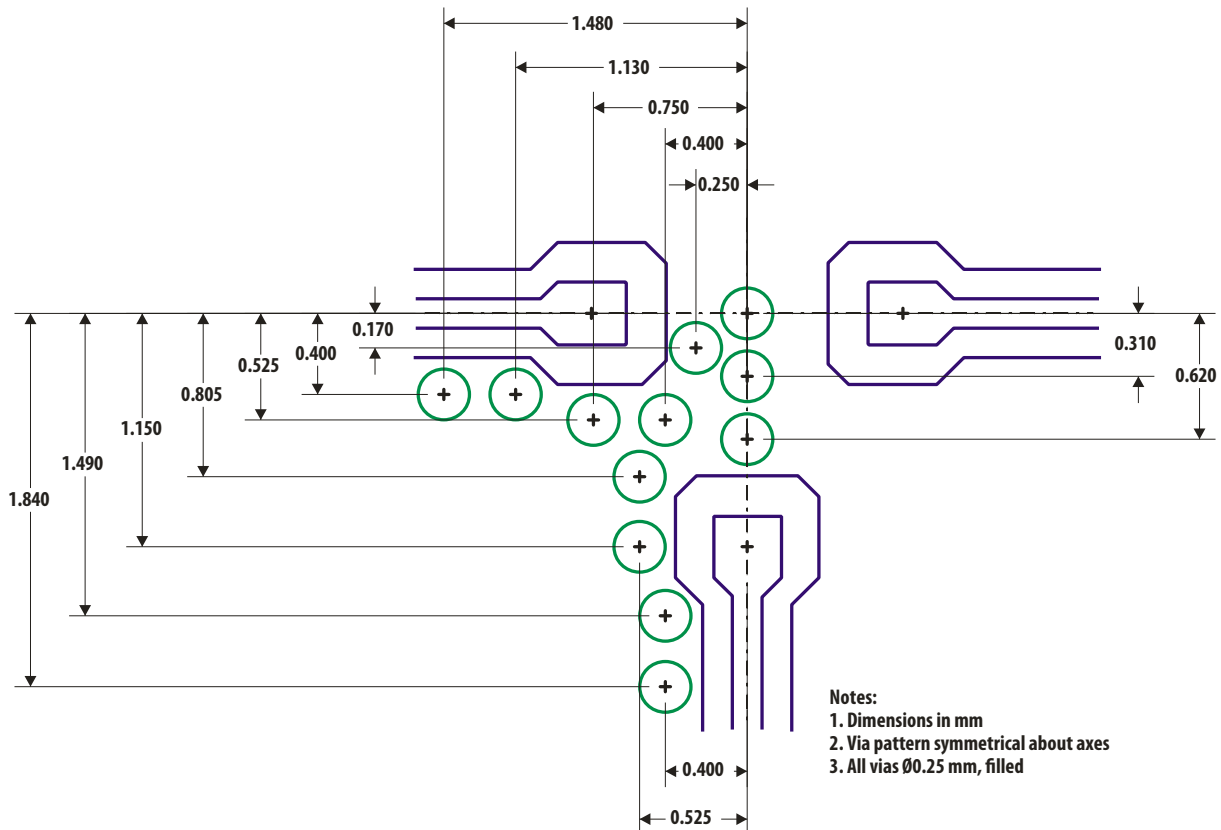

Figure 26. PCB Detail, Via Dimension

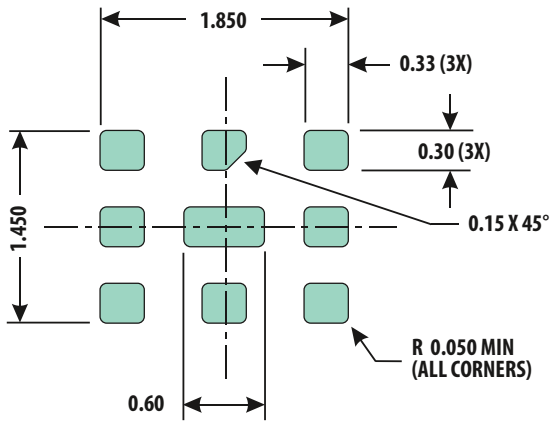

Figure 27. Recommended Solder Stencil, mm (top view)

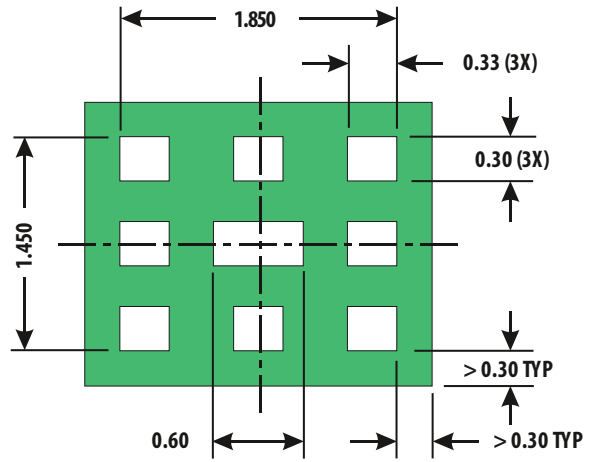

Figure 28. Recommended Solder Mask, mm (top view)

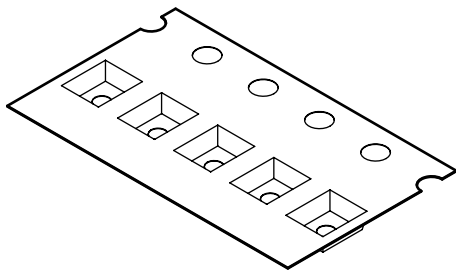
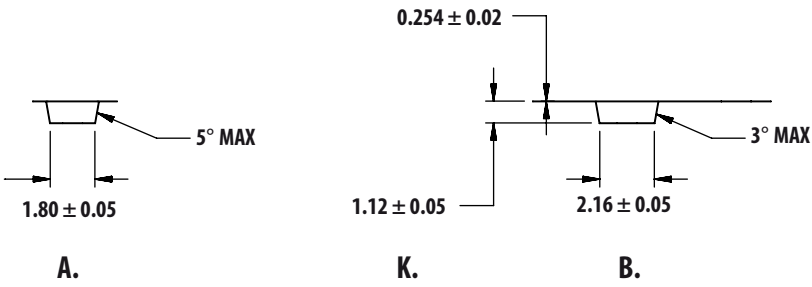
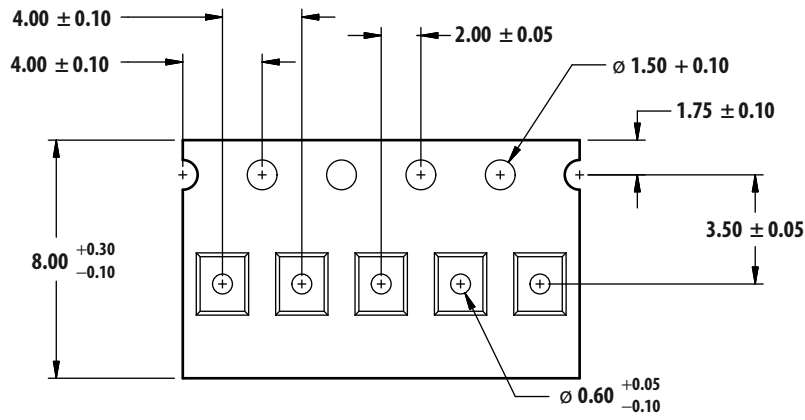

Figure 29. SMD Tape Packing

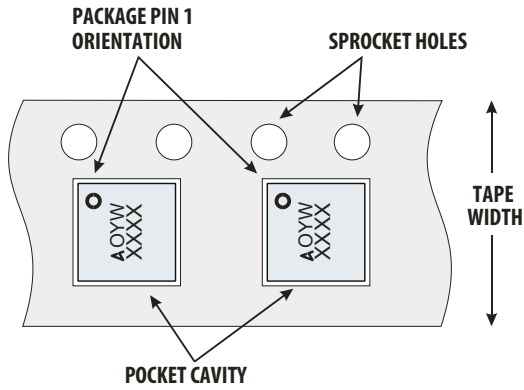
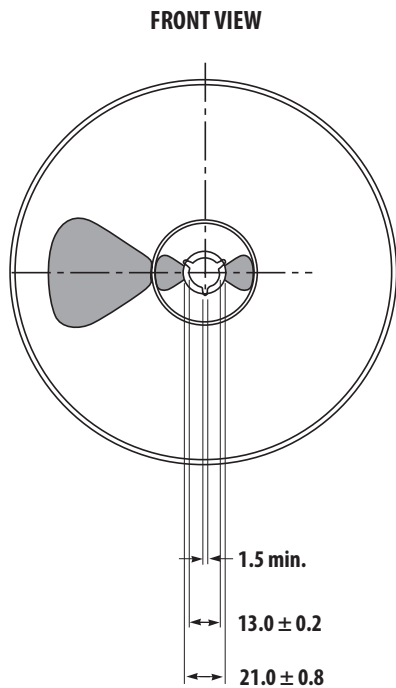

Figure 30. Orientation in Tape



NOTES:

1. Reel shall be labeled with the following information (as a minimum).
 - a. manufacturers name or symbol
 - b. Avago Technologies part number
 - c. purchase order number
 - d. date code
 - e. quantity of units
2. A certificate of compliance (c of c) shall be issued and accompany each shipment of product.
3. Reel must not be made with or contain ozone depleting materials.
4. All dimensions in millimeters (mm)

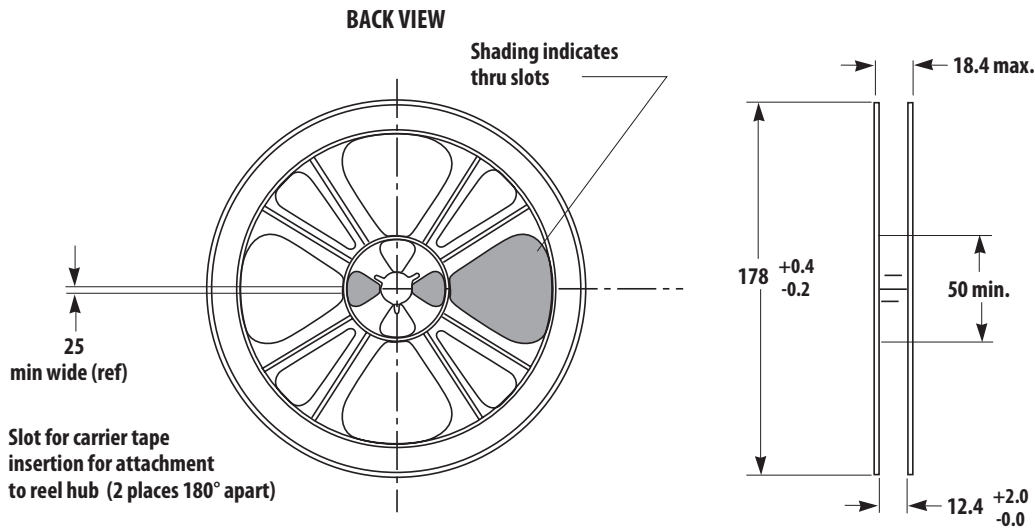

Figure 31. SMT Reel Drawing

Package Moisture Sensitivity

Feature	Test Method	Performance
Moisture Sensitivity Level (MSL) at 260°C	JESD22-A113D	Level 3

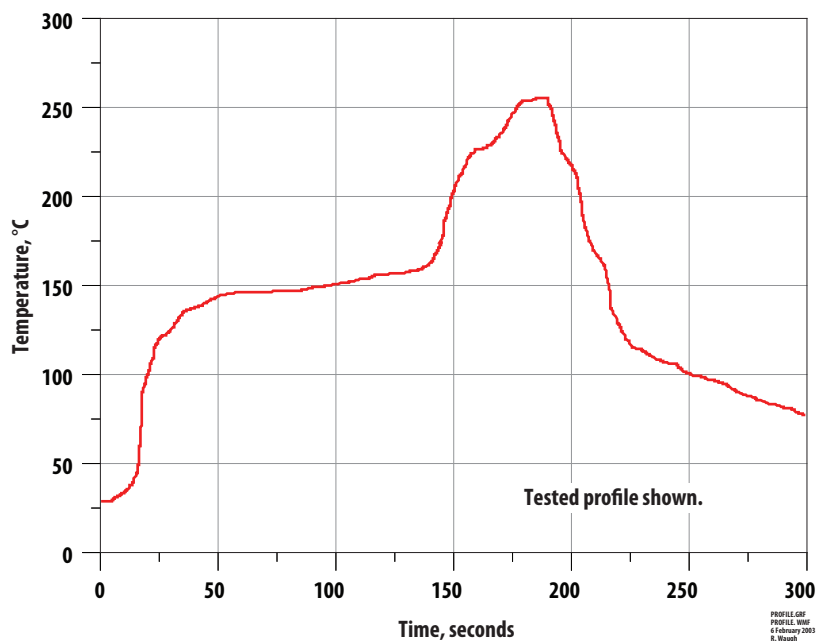

Figure 32. Verified SMT Solder Profile

Ordering Information

Part Number	No. of Devices	Container
ACMD-6125-BLK	100	Tape Strip or Anti-static Bag
ACMD-6125-TR1	3000	178 mm (7-inch) Reel

For product information and a complete list of distributors, please go to our web site: www.avagotech.com

Avago, Avago Technologies, and the A logo are trademarks of Avago Technologies in the United States and other countries. Data subject to change. Copyright © 2005-2014 Avago Technologies. All rights reserved.
AV02-4214EN - October 2, 2014

AVAGO
TECHNOLOGIES