



Chipsmall Limited consists of a professional team with an average of over 10 year of expertise in the distribution of electronic components. Based in Hongkong, we have already established firm and mutual-benefit business relationships with customers from,Europe,America and south Asia,supplying obsolete and hard-to-find components to meet their specific needs.

With the principle of “Quality Parts,Customers Priority,Honest Operation,and Considerate Service”,our business mainly focus on the distribution of electronic components. Line cards we deal with include Microchip,ALPS,ROHM,Xilinx,Pulse,ON,Everlight and Freescale. Main products comprise IC,Modules,Potentiometer,IC Socket,Relay,Connector.Our parts cover such applications as commercial,industrial, and automotives areas.

We are looking forward to setting up business relationship with you and hope to provide you with the best service and solution. Let us make a better world for our industry!



## Contact us

Tel: +86-755-8981 8866 Fax: +86-755-8427 6832

Email & Skype: info@chipsmall.com Web: www.chipsmall.com

Address: A1208, Overseas Decoration Building, #122 Zhenhua RD., Futian, Shenzhen, China



# ACPL-P481 and ACPL-W481

Inverted Logic, High CMR Optocoupler for Intelligent Power Modules and IGBT/MOSFET Gate Drive



## Data Sheet

### Description

The high-speed ACPL-P481/W481 optocoupler contains a GaAsP LED, photo detector and a Schmitt trigger that eliminates the need for external waveform conditioning circuits.

The totem pole output eliminates the need for a pull-up resistor. An Intelligent Power Module, Power MOSFET or IGBT can be driven directly.

Propagation delay difference between devices has been minimized to maximize inverter efficiency through reduced switching dead time.

### Applications

- IPM Interface Isolation
- Isolated IGBT/MOSFET Gate Drive
- AC and Brushless DC Motor Drives
- Industrial Inverters
- General Digital Isolation

### Functional Diagram

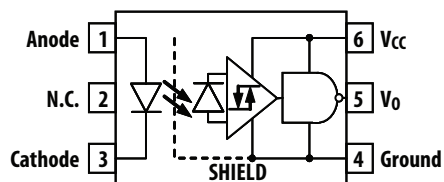

Note: A 0.1  $\mu$ F bypass capacitor must be connected between pins 4 and 6.

### Truth Table (Positive Logic)

LED	$V_0$
ON	LOW
OFF	HIGH

### Features

- Inverted output type (totem pole output)
- Performance Specified for Common IPM Applications Over Industrial Temperature Range.
- Short Maximum Propagation Delays
- Minimized Pulse Width Distortion (PWD)
- Very High Common Mode Rejection (CMR)
- Hysteresis
- Available in Stretched SO-6 Package.
- Package Clearance/Creepage at 8 mm (ACPL-W481)
- Safety Approval: (pending)
  - UL Recognized with 3750  $V_{rms}$  (5000  $V_{rms}$  for ACPL-W481) for 1 minute per UL1577.
  - CSA Approved.
  - IEC/EN/DIN EN 60747-5-5 Approved with  $V_{IORM} = 891 V_{peak}$  for ACPL-P481 and  $V_{IORM} = 1140 V_{peak}$  for ACPL-W481, under option 060.

### Specifications

- Wide Operating Temperature Range:  $-40^{\circ}\text{C}$  to  $100^{\circ}\text{C}$ .
- Maximum Propagation Delay  $t_{PHL} / t_{PLH} = 350$  ns
- Maximum Pulse Width Distortion (PWD) = 250 ns.
- Propagation Delay Difference: Min.  $-100$  ns, Max. 250 ns
- Wide Operating  $V_{CC}$  Range: 4.5 V to 20 V
- 20  $\text{kV}/\mu\text{s}$  Minimum Common Mode Rejection (CMR) at  $V_{CM} = 1000$  V.

**CAUTION:** It is advised that normal static precautions be taken in handling and assembly of this component to prevent damage and/or degradation which may be induced by ESD.

## Ordering Information

ACPL-P481/W481 is UL recognized with 3750/5000 Vrms for 1 minute respectively per UL 1577. Both are approved under CSA Component Acceptance Notice #5, File CA 88324.

Part number	Option		Surface Mount	Tape & Reel	IEC/EN/DIN EN 60747-5-5	Quantity
	RoHS Compliant	Package				
ACPL-P481 ACPL-W481	-000E	Stretched SO-6	X			100 per tube
	-500E		X	X		1000 per reel
	-060E		X		X	100 per tube
	-560E		X	X	X	1000 per reel

To order, choose a part number from the part number column and combine with the desired option from the option column to form an ordering part number.

### Example 1:

ACPL-P481-560E: Stretched SO-6 Surface Mount package in Tape and Reel packaging with IEC/EN/DIN EN 60747-5-5 Safety Approval and RoHS compliant.

### Example 2:

ACPL-P481-000E: Stretched SO-6 Surface Mount package in tube packaging and RoHS compliant.

Option datasheets are available. Contact your Avago sales representative or authorized distributor for information.

## Package Outline Drawings

### ACPL-P481 Stretched SO-6 Package, 7 mm clearance

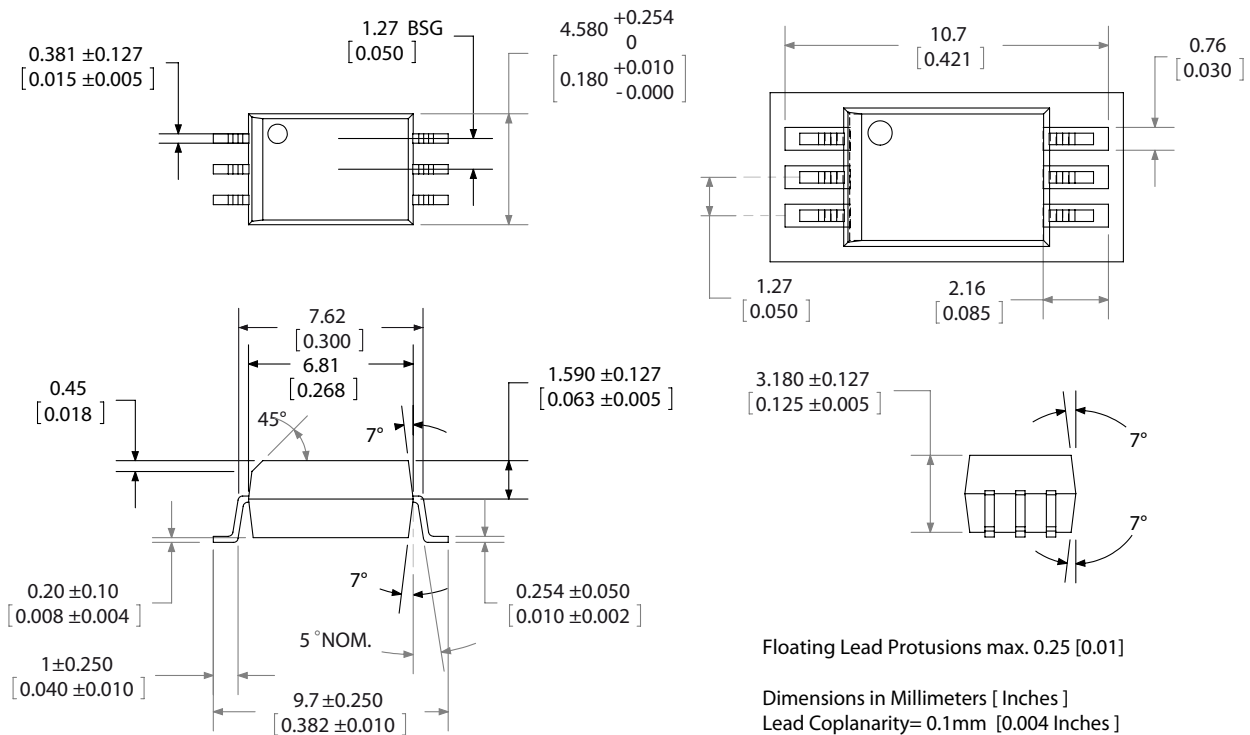

## ACPL-W481 Stretched SO-6 Package, 8 mm clearance

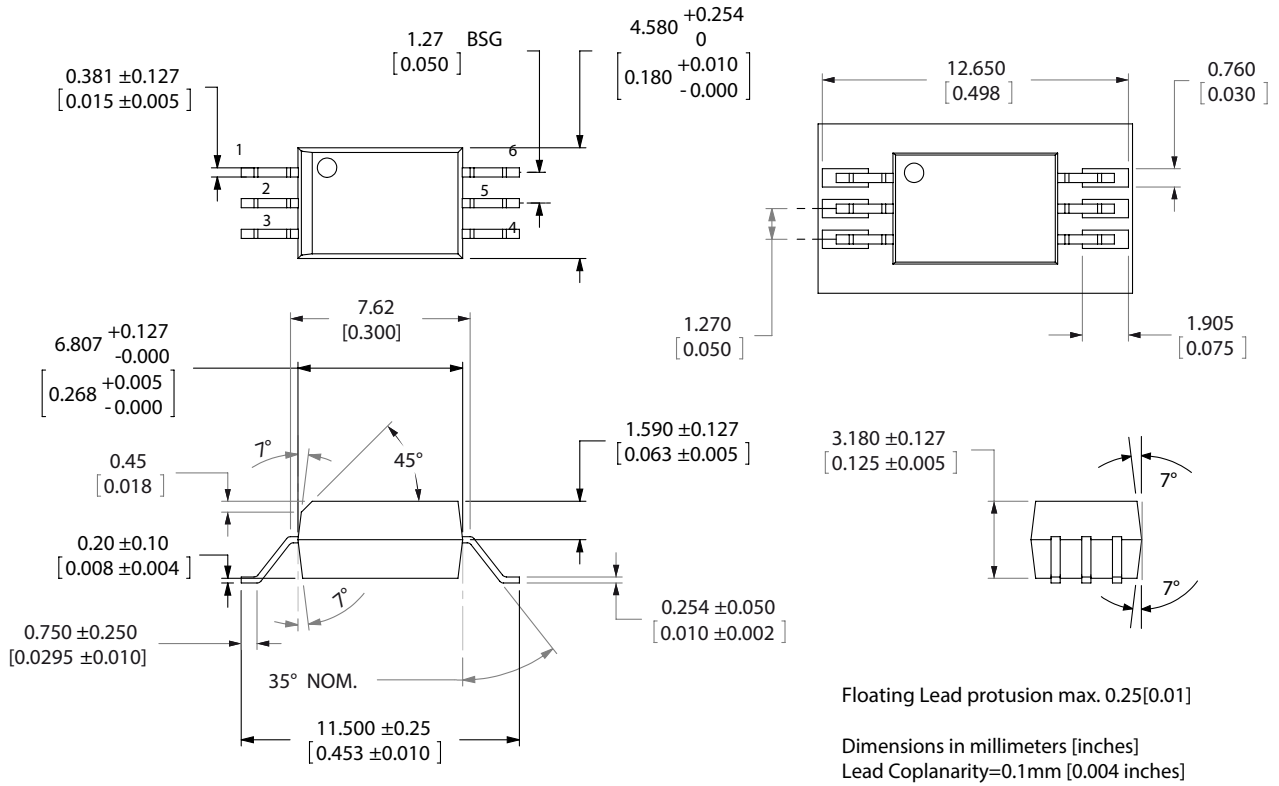

## Recommended Pb-Free IR Profile

The recommended reflow profile is per JEDEC Standard, J-STD-020 (latest revision). Non-halide flux should be used.

## Regulatory Information

The ACPL-P481/W481 is approved by the following organizations:

### IEC/EN/DIN EN 60747-5-5 (Option 060 only)

Approved with Maximum Working Insulation Voltage  $V_{IORM} = 891 V_{peak}$  for ACPL-P481 and  $V_{IORM} = 1140 V_{peak}$  for ACPL-W481

### UL

Approval under UL 1577, component recognition program up to  $V_{ISO} = 3750 V_{RMS}$  (5000 Vrms for ACPL-W481). File E55361.

### CSA

Approval under CSA Component Acceptance Notice #5, File CA 88324.

**Table 1. IEC/EN/DIN EN 60747-5-5 Insulation Characteristics\* (ACPL-P481/W481 Option 060)**

Description	Symbol	ACPL-P481	ACPL-W481	Unit
Installation Classification per DIN VDE 0110/39, Table 1 for rated mains voltage $\leq 150$ Vrms for rated mains voltage $\leq 300$ Vrms for rated mains voltage $\leq 600$ Vrms		I – IV I – IV I – III	I – IV I – IV I – IV	
Climatic Classification		55/100/21	55/100/21	
Pollution Degree (DIN VDE 0110/39)		2	2	
Maximum Working Insulation Voltage	$V_{IORM}$	891	1140	$V_{peak}$
Input to Output Test Voltage, Method b* $V_{IORM} \times 1.875 = V_{PR}$ , 100% Production Test with $t_m = 1$ sec, Partial Discharge $< 5$ pC	$V_{PR}$	1670	2137	$V_{peak}$
Input to Output Test Voltage, Method a* $V_{IORM} \times 1.6 = V_{PR}$ , Type and Sample Test, $t_m = 10$ sec, Partial Discharge $< 5$ pC	$V_{PR}$	1426	1824	$V_{peak}$
Highest Allowable Overvoltage (Transient Overvoltage $t_{ini} = 60$ sec)	$V_{IOTM}$	6000	8000	$V_{peak}$
Safety-limiting Values – maximum values allowed in the event of a failure.				
Case Temperature	$T_S$	175	175	$^{\circ}C$
Input Current	$I_{S, INPUT}$	230	230	mA
Output Power	$P_{S, OUTPUT}$	600	600	mW
Insulation Resistance at $T_S$ , $V_{IO} = 500$ V	$R_S$	$>10^9$	$>10^9$	$\Omega$

\* Refer to the optocoupler section of the Isolation and Control Components Designer's Catalog, under the Product Safety Regulations section, (IEC/EN/DIN EN 60747-5-5), for a detailed description of Method a and Method b partial discharge test profiles.

**Table 2. Insulation and Safety Related Specifications**

Parameter	Symbol	ACPL-P481	ACPL-W481	Units	Conditions
Minimum External Air Gap (External Clearance)	L(101)	7.0	8.0	mm	Measured from input terminals to output terminals, shortest distance through air.
Minimum External Tracking (External Creepage)	L(102)	8.0	8.0	mm	Measured from input terminals to output terminals, shortest distance path along body.
Minimum Internal Plastic Gap (Internal Clearance)		0.08	0.08	mm	Through insulation distance conductor to conductor, usually the straight line distance thickness between the emitter and detector.
Tracking Resistance (Comparative Tracking Index)	CTI	$>175$	$>175$	V	DIN IEC 112/VDE 0303 Part 1
Isolation Group		IIIa	IIIa		Material Group (DIN VDE 0110, 1/89, Table 1)

**Table 3. Absolute Maximum Ratings**

Parameter	Symbol	Min.	Max.	Units	Note
Storage Temperature	$T_S$	-55	125	°C	
Operating Temperature	$T_A$	-40	100	°C	
Average Input Current	$I_{F(avg)}$		10	mA	
Peak Transient Input Current ( $< 1 \mu s$ pulse width, 300 pps) ( $< 200 \mu s$ pulse width, $< 1\%$ duty cycle)	$I_{F(tran)}$		1.0 40	A mA	
Reverse Input Voltage	$V_R$		5	V	
Average Output Current	$I_O$		25	mA	
Supply Voltage	$V_{CC}$	0	25	V	
Output Voltage	$V_O$	-0.5	25	V	
Total Package Power Dissipation	$P_T$		210	mW	1

**Table 4. Recommended Operating Conditions**

Parameter	Symbol	Min.	Max.	Units	Note
Power Supply Voltage	$V_{CC}$	4.5	20	V	2
Forward Input Current (OFF)	$I_{F(OFF)}$	6	10	mA	
Forward Input Voltage (ON)	$V_{F(ON)}$	-	0.8	V	
Operating Temperature	$T_A$	-40	100	°C	

**Table 5. Electrical Specifications**

Over recommended operating conditions  $T_A = -40\text{ }^\circ\text{C}$  to  $100\text{ }^\circ\text{C}$ ,  $V_{CC} = +4.5\text{ V}$  to  $20\text{ V}$ ,  $I_{F(ON)} = 6\text{ mA}$  to  $10\text{ mA}$ ,  $V_{F(OFF)} = 0\text{ V}$  to  $0.8\text{ V}$ , unless otherwise specified. All typicals at  $T_A = 25\text{ }^\circ\text{C}$ .

Parameter	Symbol	Min.	Typ.	Max.	Units	Test Conditions	Fig.	Note
Logic Low Output Voltage	$V_{OL}$			0.3	V	$I_{OL} = 3.5\text{ mA}$	1, 3	
				0.5		$I_{OL} = 6.5\text{ mA}$		
Logic High Output Voltage	$V_{OH}$	$V_{CC} - 1.8$ $V_{CC} - 2.5$	$V_{CC} - 0.9$ $V_{CC} - 1.2$		V	$I_{OH} = -3.5\text{ mA}$	2, 3, 7	
						$I_{OH} = -6.5\text{ mA}$		
Output Leakage Current ( $V_O = V_{CC} + 0.5\text{ V}$ )	$I_{OHH}$			100	$\mu\text{A}$	$V_{CC} = 5\text{ V}, V_F = 0\text{ V}$		
				500	$\mu\text{A}$	$V_{CC} = 20\text{ V}, V_F = 0\text{ V}$		
Logic Low Supply Current	$I_{CCL}$		1.9	3.0	mA	$V_{CC} = 5.5\text{ V}, I_F = 10\text{ mA}, I_O = 0\text{ mA}$		
			2.0	3.0	mA	$V_{CC} = 20\text{ V}, I_F = 10\text{ mA}, I_O = 0\text{ mA}$		
Logic High Supply Current	$I_{CCH}$		1.5	2.5	mA	$V_{CC} = 5.5\text{ V}, V_F = 0\text{ V}, I_O = 0\text{ mA}$		
			1.6	2.5	mA	$V_{CC} = 20\text{ V}, V_F = 0\text{ V}, I_O = 0\text{ mA}$		
Logic Low Short Circuit Output Current	$I_{OSL}$	25			mA	$V_O = V_{CC} = 5.5\text{ V}, I_F = 10\text{ mA}$		3
		50			mA	$V_O = V_{CC} = 20\text{ V}, I_F = 10\text{ mA}$		
Logic High Short Circuit Output Current	$I_{OSH}$			-25	mA	$V_{CC} = 5.5\text{ V}, V_F = 0\text{ V}, V_O = \text{GND}$		3
				-50	mA	$V_{CC} = 20\text{ V}, V_F = 0\text{ V}, V_O = \text{GND}$		
Input Forward Voltage	$V_F$		1.5	1.7	V	$T_A = 25\text{ }^\circ\text{C}, I_F = 6\text{ mA}$		4
				1.85	V	$I_F = 6\text{ mA}$		
Input Reverse Breakdown Voltage	$BV_R$	5			V	$I_R = 10\text{ }\mu\text{A}$		
Input Diode Temperature Coefficient	$\Delta V_F / \Delta T_A$		1.7		mV/ $^\circ\text{C}$	$I_F = 6\text{ mA}$		
Input Capacitance	$C_{IN}$		60		pF	$f = 1\text{ MHz}, V_F = 0\text{ V}$		4

**Table 6. Switching Specifications**

Over recommended operating conditions  $T_A = -40\text{ }^\circ\text{C}$  to  $100\text{ }^\circ\text{C}$ ,  $V_{CC} = +4.5\text{ V}$  to  $20\text{ V}$ ,  $I_{F(ON)} = 6\text{ mA}$  to  $10\text{ mA}$ ,  $V_{F(OFF)} = 0\text{ V}$  to  $0.8\text{ V}$ , unless otherwise specified. All typicals at  $T_A = 25\text{ }^\circ\text{C}$ .

Parameter	Symbol	Min.	Typ.	Max.	Units	Test Conditions	Fig.	Note
Propagation Delay Time to Logic Low Output Level	$t_{PHL}$		110	350	ns	With Peaking Capacitor	5, 6	6
Propagation Delay Time to Logic High Output Level	$t_{PLH}$		140	350	ns	With Peaking Capacitor	5, 6	6
Pulse Width Distortion	$ t_{PHL} - t_{PLH} $ = PWD			250	ns			9
Propagation Delay Difference Between Any Two Parts	PDD	-100		250	ns			11
Output Rise Time (10-90%)	$t_r$		16		ns		5, 8	
Output Fall Time (90-10%)	$t_f$		20		ns		5, 8	
Logic High Common Mode Transient Immunity	$ CM_H $	20			kV/ $\mu\text{s}$	$ V_{CM}  = 1000\text{ V}, V_F = 0\text{ V},$ $V_{CC} = 5\text{ V}, T_A = 25\text{ }^\circ\text{C}$	9	7
Logic Low Common Mode Transient Immunity	$ CM_L $	20			kV/ $\mu\text{s}$	$ V_{CM}  = 1000\text{ V}, I_F = 6.0\text{ mA},$ $V_{CC} = 5\text{ V}, T_A = 25\text{ }^\circ\text{C}$	9	7

**Table 7. Package Characteristics**

Parameter	Symbol	Min.	Typ.	Max.	Units	Test Conditions	Fig.	Note
Input-Output Momentary Withstand Voltage*	$V_{ISO}$	3750 (ACPL-P481) 5000 (ACPL-W481)			$V_{rms}$	RH < 50%, t = 1 min. $T_A = 25^\circ C$		5, 8
Input-Output Resistance	$R_{I-O}$		$10^{12}$			$V_{I-O} = 500 V_{dc}$		5
Input-Output Capacitance	$C_{I-O}$		0.6			f = 1 MHz, $V_{I-O} = 0 V_{dc}$		5

\* The Input-Output Momentary Withstand Voltage is a dielectric voltage rating that should not be interpreted as an input-output continuous voltage rating. For the continuous voltage rating refer to the IEC/EN/DIN EN 60747-5-5 Insulation Characteristics Table (if applicable).

Notes:

- Derate total package power dissipation,  $P_T$ , linearly above  $70^\circ C$  free-air temperature at a rate of  $4.5 \text{ mW}/^\circ C$ .
- Detector requires a VCC of 4.5V or higher for stable operation as output might be unstable if VCC is lower than 4.5V. Be sure to check the power ON/OFF operation other than the supply current.
- Duration of output short circuit time should not exceed 10 ms.
- Input capacitance is measured between pin 1 and pin 3.
- Device considered a two-terminal device: pins 1, 2 and 3 shorted together and pins 4, 5 and 6 shorted together.
- The  $t_{PLH}$  propagation delay is measured from the 50% point on the leading edge of the input pulse to the 1.3 V point on the trailing edge of the output pulse. The  $t_{PHL}$  propagation delay is measured from the 50% point on the trailing edge of the input pulse to the 1.3 V point on the leading edge of the output pulse.
- $CM_H$  is the maximum slew rate of the common mode voltage that can be sustained with the output voltage in the logic high state,  $V_O > 2.0 \text{ V}$ .  $CM_L$  is the maximum slew rate of the common mode voltage that can be sustained with the output voltage in the logic low state,  $V_O < 0.8 \text{ V}$ .
- In accordance with UL 1577, each optocoupler is proof tested by applying an insulation test voltage  $\geq 4500 V_{RMS}$  ( $6000 V_{RMS}$  for ACPL-W481) for one second (leakage detection current limit,  $I_{I-O} \leq 5 \mu A$ ). This test is performed before the 100% production test for partial discharge (Method b) shown in the IEC/EN/DIN EN 60747-5-5 Insulation Characteristics Table, if applicable.
- Pulse Width Distortion (PWD) is defined as  $|t_{PHL} - t_{PLH}|$  for any given device.
- Use of a  $0.1 \mu F$  bypass capacitor connected between pins 4 and 6 is recommended.
- The difference between  $t_{PLH}$  and  $t_{PHL}$  between any two devices under the same test condition.



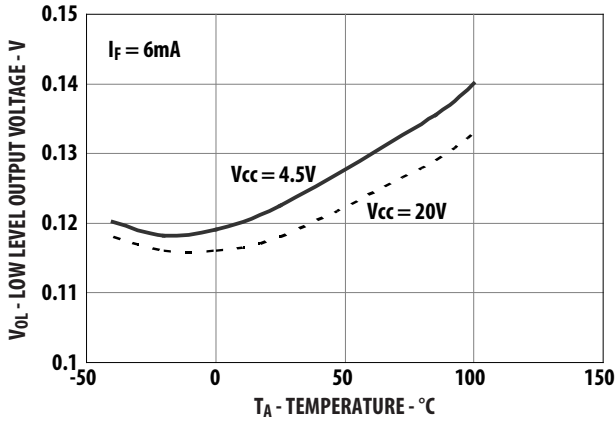

Figure 1. Typical Logic Low Output Voltage vs. Temperature

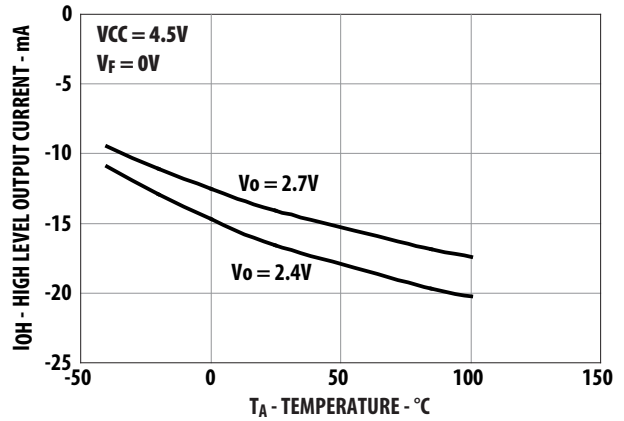

Figure 2. Typical Logic High Output Current vs. Temperature

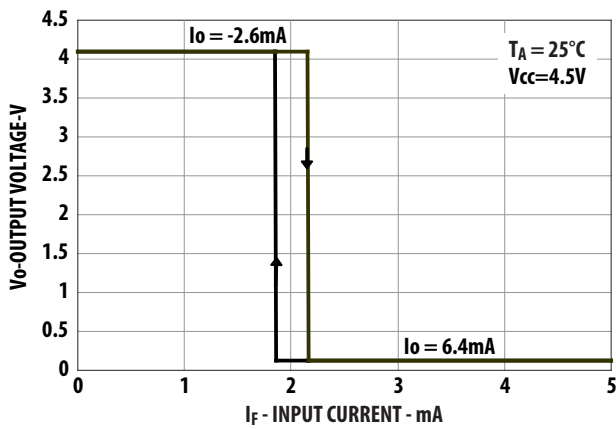

Figure 3. Typical Output Voltage vs. Forward Input Current

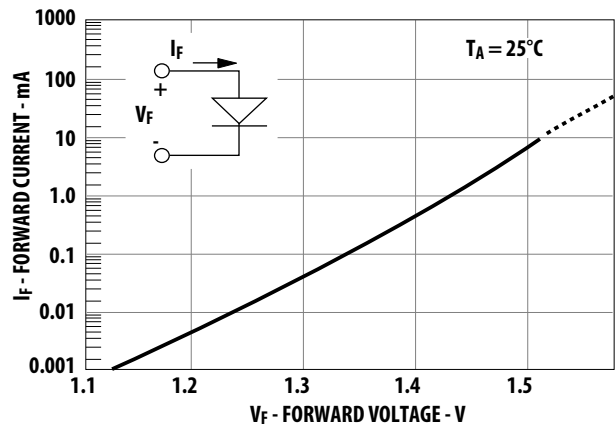

Figure 4. Typical Input Diode Forward Characteristic

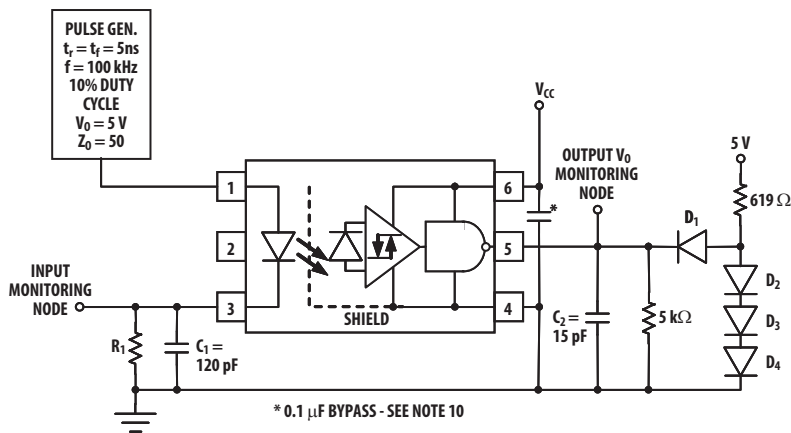
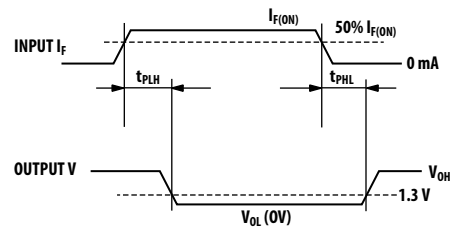

Figure 5. Test Circuit for  $t_{pLH}$ ,  $t_{pHL}$ ,  $t_r$ , and  $t_f$

THE PROBE AND JIG CAPACITANCES  
ARE INCLUDED IN  $C_1$  AND  $C_2$ .

$R_1$	660 $\Omega$	330 $\Omega$
$I_{F(ON)}$	6 mA	10 mA

ALL DIODES ARE EITHER 1N916 OR 1N3064



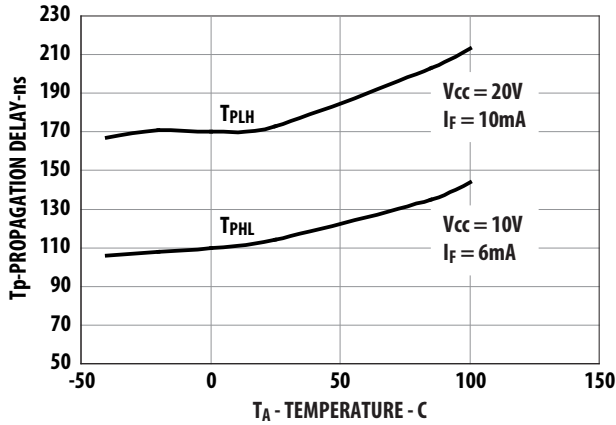

Figure 6. Typical Propagation Delays vs. Temperature.

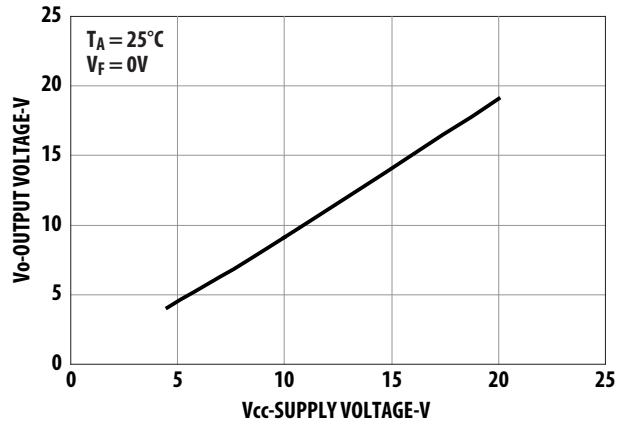

Figure 7. Typical Logic High Output Voltage vs. Supply Voltage

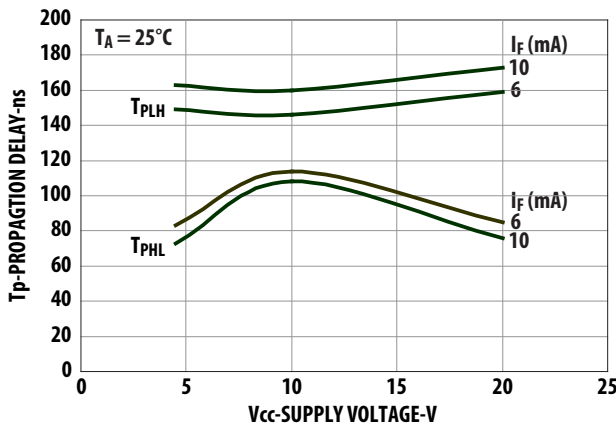

Figure 8. Typical Propagation Delay vs. Supply Voltage

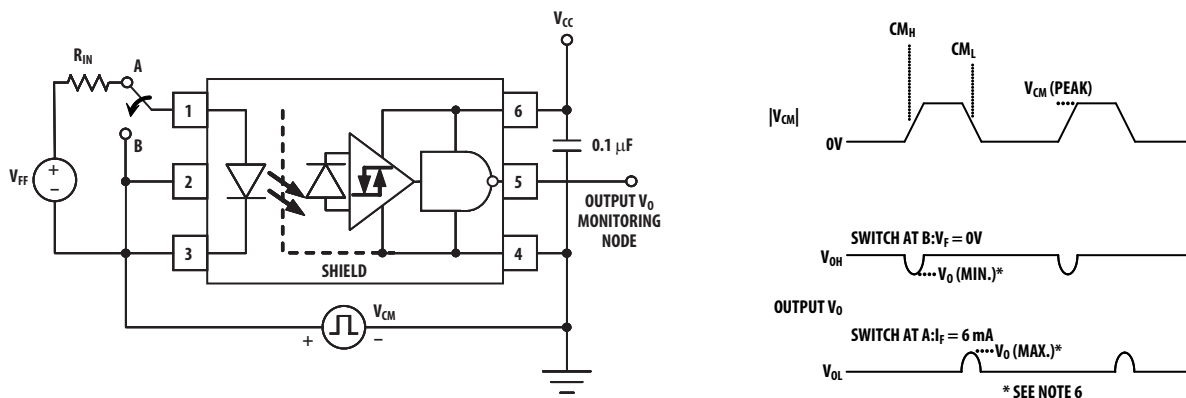

Figure 9. Test Circuit for Common Mode Transient Immunity and Typical Waveforms

For product information and a complete list of distributors, please go to our web site: [www.avagotech.com](http://www.avagotech.com)

Avago, Avago Technologies, and the A logo are trademarks of Avago Technologies in the United States and other countries. Data subject to change. Copyright © 2005-2012 Avago Technologies. All rights reserved. AV02-2122EN - December 21, 2012

