



Chipsmall Limited consists of a professional team with an average of over 10 year of expertise in the distribution of electronic components. Based in Hongkong, we have already established firm and mutual-benefit business relationships with customers from,Europe,America and south Asia,supplying obsolete and hard-to-find components to meet their specific needs.

With the principle of "Quality Parts,Customers Priority,Honest Operation,and Considerate Service",our business mainly focus on the distribution of electronic components. Line cards we deal with include Microchip,ALPS,ROHM,Xilinx,Pulse,ON,Everlight and Freescale. Main products comprise IC,Modules,Potentiometer,IC Socket,Relay,Connector.Our parts cover such applications as commercial,industrial, and automotives areas.

We are looking forward to setting up business relationship with you and hope to provide you with the best service and solution. Let us make a better world for our industry!



Contact us

Tel: +86-755-8981 8866 Fax: +86-755-8427 6832

Email & Skype: info@chipsmall.com Web: www.chipsmall.com

Address: A1208, Overseas Decoration Building, #122 Zhenhua RD., Futian, Shenzhen, China





ACS110-7SN/SB2

ASD™ AC Switch Family

AC LINE SWITCH

MAIN APPLICATIONS

- AC static switching in appliance control systems
- Drive of low power high inductive or resistive loads like
 - relay, valve, solenoid, dispenser
 - pump, fan, micro-motor
 - defrost heater

FEATURES

- Blocking voltage : $V_{DRM} / V_{RRM} = +/-700V$
- Avalanche controlled : $V_{CL\ typ} = 1100\ V$
- Nominal conducting current : $I_{T(RMS)} = 1A$
- Gate triggering current : $I_{GT} < 10\ mA$
- Switch integrated driver
- High noise immunity : static $dV/dt > 500V/\mu s$

BENEFITS

- No external protection snubber or varistor needed
- Enables equipment to meet IEC 61000-4-5 & IEC 335-1 (DIL-8 package)
- Reduces component count up to 80 %
- Interfaces directly with the microcontroller
- Eliminates any gate kick back on the microcontroller
- Allows straightforward connection of several ACS™ on same cooling pad (SOT-223)

DESCRIPTION

The ACS110 belongs to the AC line switch family built around the ASD™ concept. This high performance switch circuit is able to control a load up to 1 A.

The ACS™ switch embeds a high voltage clamping structure to absorb the inductive turn off energy and a gate level shifter driver to separate the digital controller from the main switch. It is triggered with a negative gate current flowing out of the gate pin.

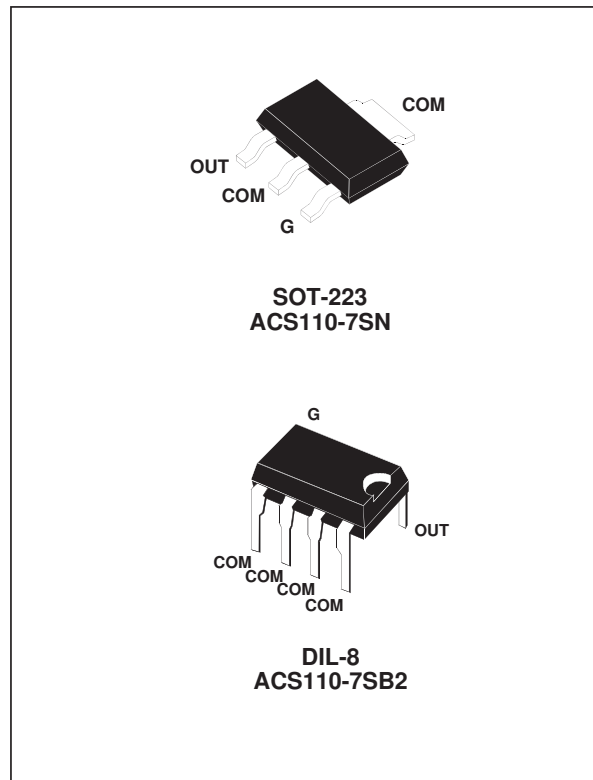

FUNCTIONAL DIAGRAM

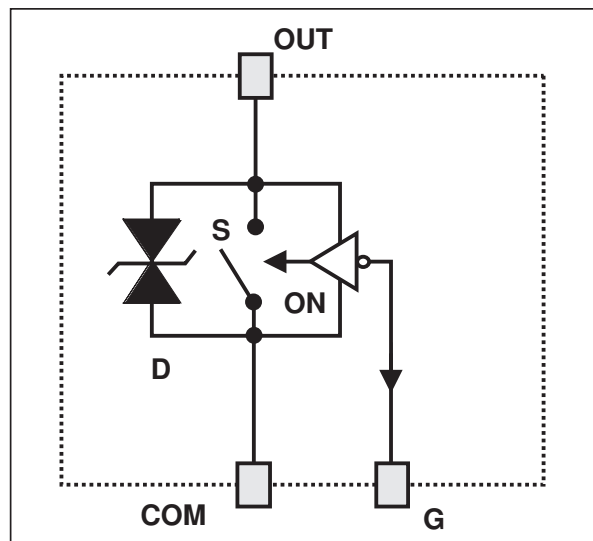

ACS110-7SN/SB2

ABSOLUTE RATINGS (limiting values)

For either positive or negative polarity of pin OUT voltage in respect to pin COM voltage

Symbol	Parameter		Value	Unit	
V_{DRM} / V_{RRM}	Repetitive peak off-state voltage		$T_j = -10\text{ °C}$	700	V
$I_{T(RMS)}$	RMS on-state current full cycle sine wave 50 to 60 Hz	SOT-223	$T_{tab} = 105\text{ °C}$	1	A
		DIL-8	$T_{lead} = 110\text{ °C}$		
I_{TSM}	Non repetitive surge peak on-state current T_j initial = 25 °C , full cycle sine wave		F = 50 Hz	8	A
			F = 60 Hz	11	A
I^2t	Fusing capability		$t_p = 10\text{ms}$	0.35	A^2s
di/dt	Repetitive on-state current critical rate of rise $I_G = 10\text{mA}$ ($t_r < 100\text{ns}$)	$T_j = 125\text{ °C}$	F = 120 Hz	50	$A/\mu s$
V_{PP}	Non repetitive line peak pulse voltage		note 1	2	kV
T_{stg}	Storage temperature range			- 40 to + 150	$^{\circ}\text{C}$
T_j	Operating junction temperature range			- 30 to + 125	$^{\circ}\text{C}$
T_l	Maximum lead soldering temperature during 10s			260	$^{\circ}\text{C}$

Note 1: according to test described by IEC61000-4-5 standard & Figure 3.

GATE CHARACTERISTICS (maximum values)

Symbol	Parameter	Value	Unit
$P_{G(AV)}$	Average gate power dissipation	0.1	W
I_{GM}	Peak gate current ($t_p = 20\mu s$)	1	A
V_{GM}	Peak positive gate voltage (in respect to pin COM)	5	V

THERMAL RESISTANCES

Symbol	Parameter	Value	Unit	
$R_{th(j-a)}$	Junction to ambient $S = 5\text{cm}^2$	SOT-223	60	$^{\circ}\text{C/W}$
		DIL-8	60	$^{\circ}\text{C/W}$
$R_{th(j-l)}$	Junction to tab/lead for full cycle sine wave conduction	SOT-223	20	$^{\circ}\text{C/W}$
		DIL-8	15	$^{\circ}\text{C/W}$

S = Copper surface under Tab

PARAMETER DESCRIPTION

Parameter Symbol	Parameter description
I_{GT}	Triggering gate current
V_{GT}	Triggering gate voltage
V_{GD}	Non-triggering gate voltage
I_H	Holding current
I_L	Latching current
V_{TM}	Peak on-state voltage drop
V_{TO}	On state threshold voltage
R_d	On state dynamic resistance
I_{DRM} / I_{RRM}	Maximum forward or reverse leakage current
dV/dt	Critical rate of rise of off-state voltage
$(dV/dt)_c$	Critical rate of rise of commutating off-state voltage
$(dI/dt)_c$	Critical rate of decrease of commutating on-state current
V_{CL}	Clamping voltage
I_{CL}	Clamping current

ELECTRICAL CHARACTERISTICS

For either positive or negative polarity of pin OUT voltage respect to pin COM voltage excepted note 3*.

Symbol	Test Conditions				Values	Unit	
I_{GT}	$V_{OUT}=12V$ (DC)	$R_L=140\Omega$	QII - QIII	$T_j=25^\circ C$	MAX	10	mA
V_{GT}	$V_{OUT}=12V$ (DC)	$R_L=140\Omega$	QII - QIII	$T_j=25^\circ C$	MAX	1	V
V_{GD}	$V_{OUT}=V_{DRM}$ $R_L=3.3k\Omega$			$T_j=125^\circ C$	MIN	0.15	V
I_H	$I_{OUT}=100mA$ gate open			$T_j=25^\circ C$	MAX	45	mA
I_L	$I_G=20mA$			$T_j=25^\circ C$	MAX	65	mA
V_{TM}	$I_{OUT}=1.4A$ $t_p=380\mu s$			$T_j=25^\circ C$	MAX	1.3	V
V_{TO}				$T_j=125^\circ C$	MAX	0.8	V
R_d				$T_j=125^\circ C$	MAX	300	m Ω
I_{DRM} / I_{RRM}	$V_{OUT}=700V$			$T_j=25^\circ C$	MAX	2	μA
				$T_j=125^\circ C$	MAX	200	
dV/dt	$V_{OUT}=460V$ gate open			$T_j=110^\circ C$	MIN	500	V/ μs
$(dI/dt)_c$	$(dV/dt)_c=20V/\mu s$			$T_j=125^\circ C$	MIN	0.5	A/ms
V_{CL}	$I_{CL}=1mA$ $t_p=1ms$			$T_j=25^\circ C$	TYP	1100	V

ACS110-7SN/SB2

AC LINE SWITCH BASIC APPLICATION

The ACS110 device is well adapted to Washing machine, dishwasher, tumble drier, refrigerator, water heaters, air-conditioning systems, microwave ovens and other cookware. It has been designed especially to switch on & off low power loads such as solenoid, valve, relay, dispenser, micro-motor, pump, fan and defrost heaters.

Pin COM: Common drive reference to connect to the power line neutral

Pin G: Switch Gate input to connect to the digital controller

Pin OUT: Switch Output to connect to the load

This ACS™ switch is triggered with a negative gate current flowing out of the gate pin G. It can be driven directly by the digital controller through a resistor as shown on the typical application diagram.

Several ACS110 devices can be connected on the same cooling PCB pad, which is the COM pin.

Thanks to its thermal and turn off commutation performances, the ACS110 switch is able to drive with no turn off additional snubber an inductive load up to 1 A.

TYPICAL APPLICATION DIAGRAM

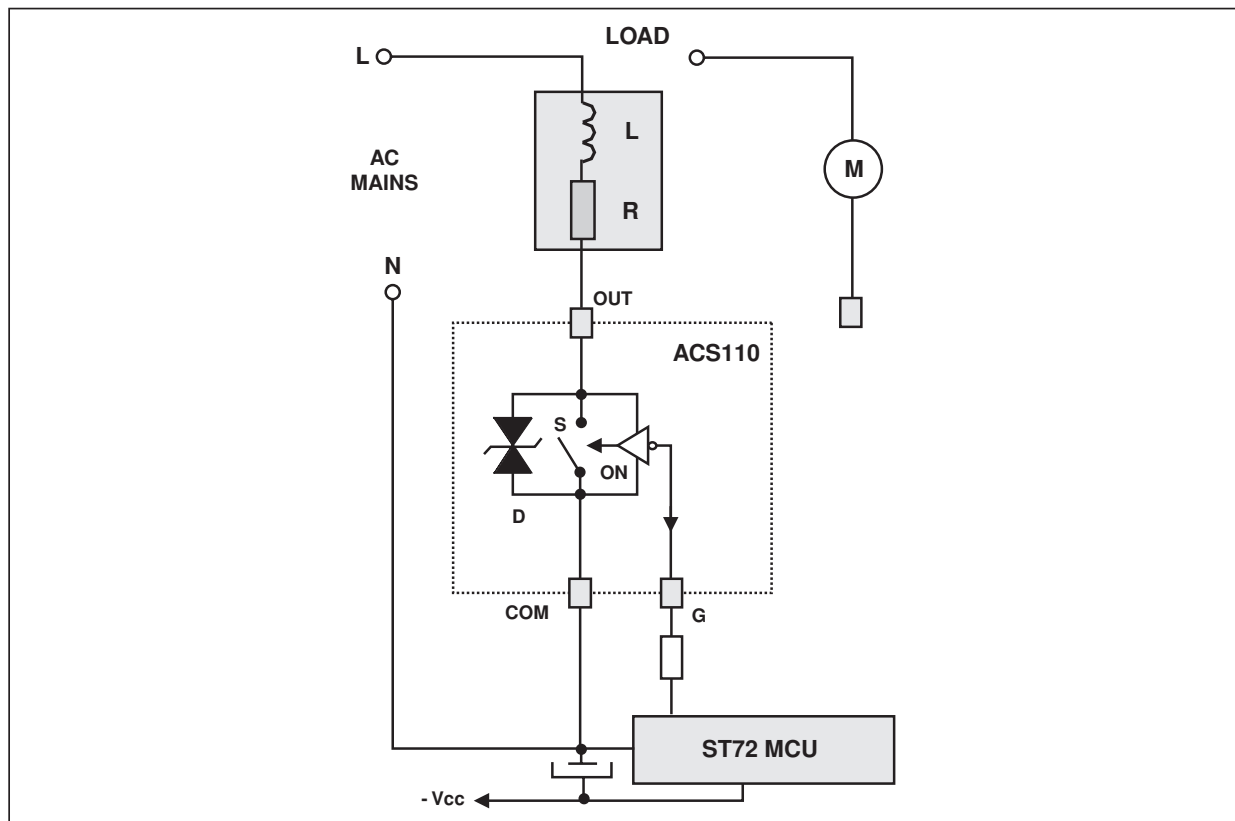

HIGH INDUCTIVE SWITCH-OFF OPERATION

At the end of the last conduction half-cycle, the load current reaches the holding current level I_H , and the ACS™ switch turns off. Because of the inductance L of the load, the current flows then through the avalanche diode D and decreases linearly to zero. During this time, the voltage across the switch is limited to the clamping voltage V_{CL} .

The energy stored in the inductance of the load depends on the holding current I_H and the inductance (up to 10 H); it can reach about 10 mJ and is dissipated in the clamping diode section. The ACS switch sustains the turn off energy because its clamping section is designed for that purpose.

Fig. A: Turn-off operation of the ACS110 switch with an electro-valve: waveform of the pin OUT current I_{OUT} and Out-COM voltage V_{OUT} .

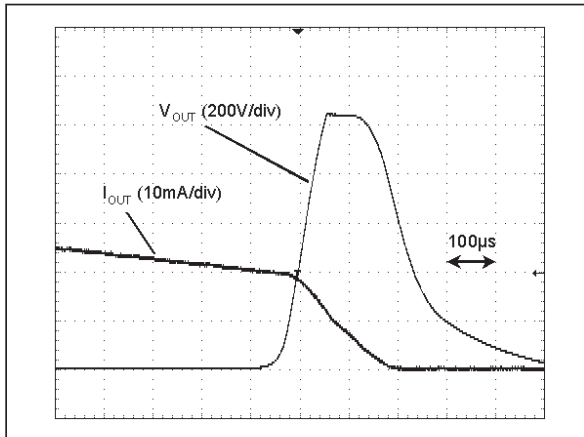
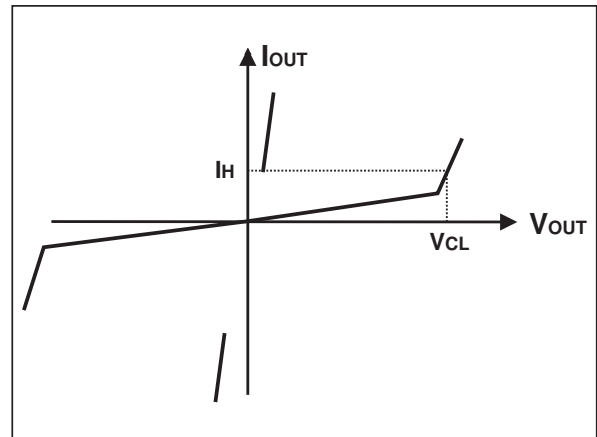

Fig. B: ACS110 switch static characteristic.



AC LINE TRANSIENT VOLTAGE RUGGEDNESS

The ACS110 switch is able to sustain safely the AC line transient voltages either by clamping the low energy spikes or by breaking over under high energy shocks, even with high turn-on current rises.

The test circuit of the figure C is representative of the final ACS application and is also used to stress the ACS switch according to the IEC 61000-4-5 standard conditions. Thanks to the load, the ACS switch sustains the voltage spikes up to 2 kV above the peak line voltage. It will break over safely even on resistive load where the turn on current rise is high as shown on figure D. Such non repetitive test can be done 10 times on each AC line voltage polarity.

Fig. C: Overvoltage ruggedness test circuit for resistive and inductive loads according to IEC61000-4-5 standards. $R = 150\Omega$, $L = 10\mu H$, $V_{PP} = 2kV$.

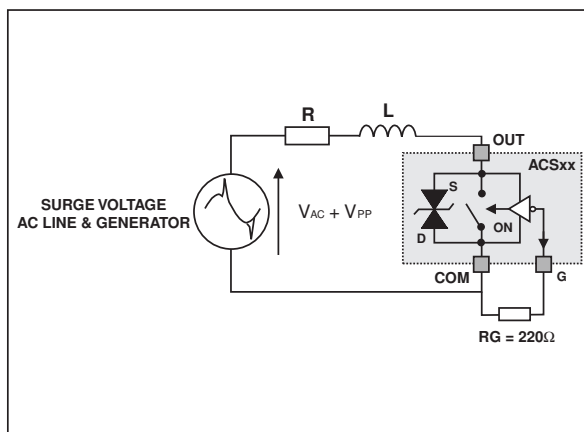
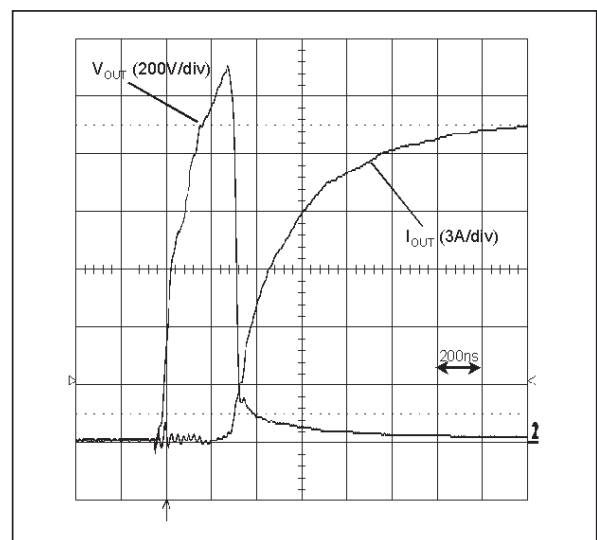

Fig. D: Current and Voltage of the ACS110 during IEC61000-4-5 standard test with $R = 150\Omega$, $L = 10\mu H$ & $V_{PP} = 2kV$.



OTHER FIGURES

- Maximum power dissipation vs RMS on state current.
- RMS on-state current vs ambient temperature, case temperature and package
- Relative variation of thermal impedance junction to ambient vs pulse duration and package
- Relative variation of gate trigger current vs junction temperature
- Relative variation of holding and latching current vs junction
- Relative variation of dV/dt vs T_j
- Relative variation of $(dV/dt)_c$ vs $(di/dt)_c$
- Surge peak on-state current vs number of cycles
- Non repetitive surge peak on-state current for a sinusoidal pulse with $t_p < 10ms$, and corresponding of I^2t .
- On-state characteristics (maximal values)
- Thermal resistance junction to ambient vs copper surface under tab
- Relative variation of critical $(di/dt)_c$ vs junction temperature

Fig. 1: Maximum power dissipation versus RMS on-state current.

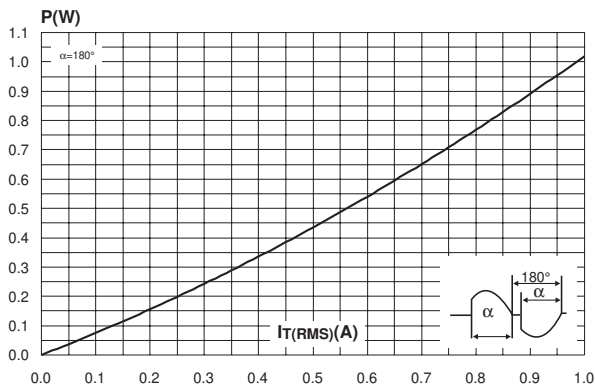

Fig. 2-1: RMS on-state current versus tab or lead temperature.

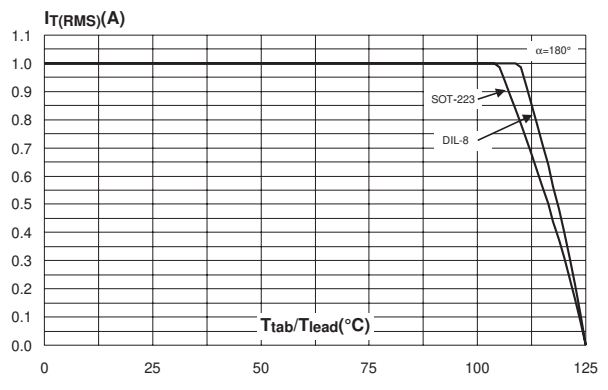

Fig. 2-2: RMS on-state current versus ambient temperature.

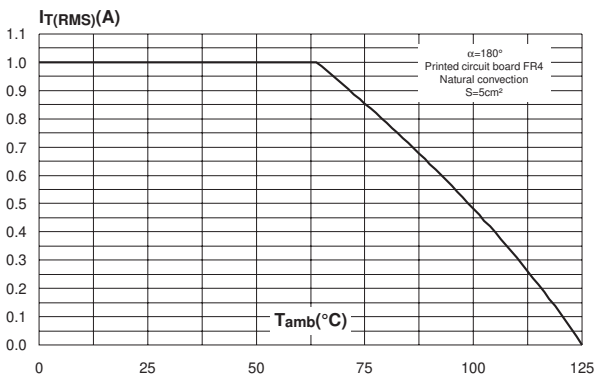

Fig. 3: Relative variation of thermal impedance junction to ambient versus pulse duration.

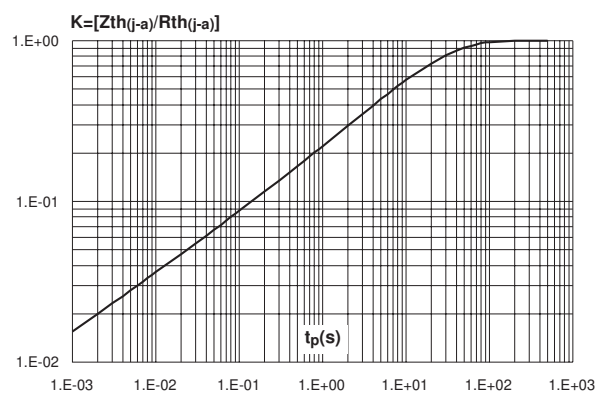

Fig. 4: Relative variation of gate trigger current, holding current and latching versus junction temperature (typical values).

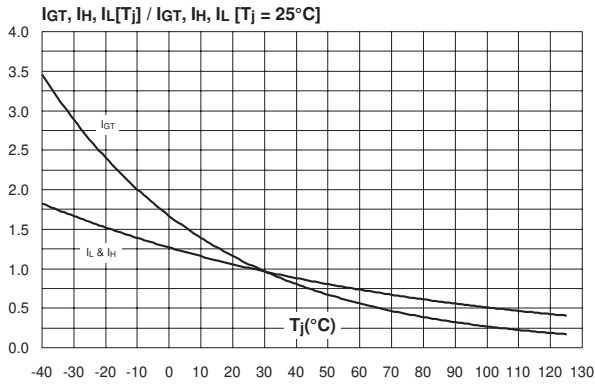

Fig. 5: Relative variation of static dV/dt versus junction temperature.

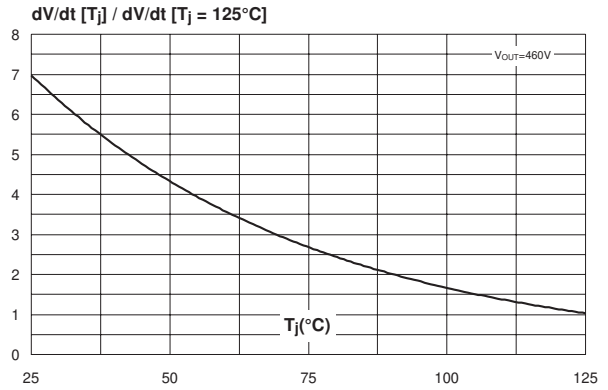

Fig. 6: Relative variation of critical rate of decrease of main current versus reapplied dV/dt (typical values).

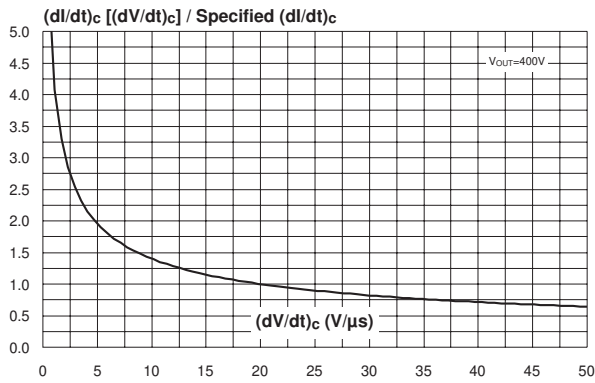

Fig. 7: Relative variation of critical rate of decrease of main current versus junction temperature.

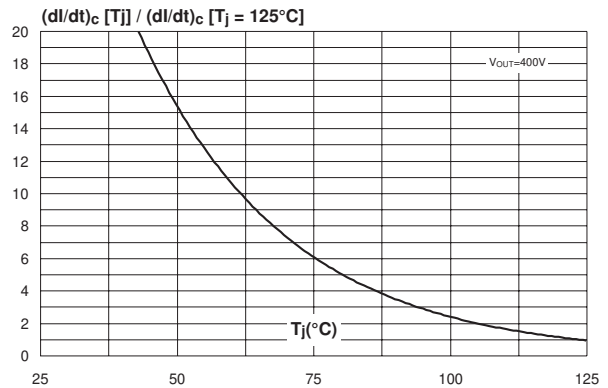

Fig. 8: Surge peak on-state current versus number of cycles.

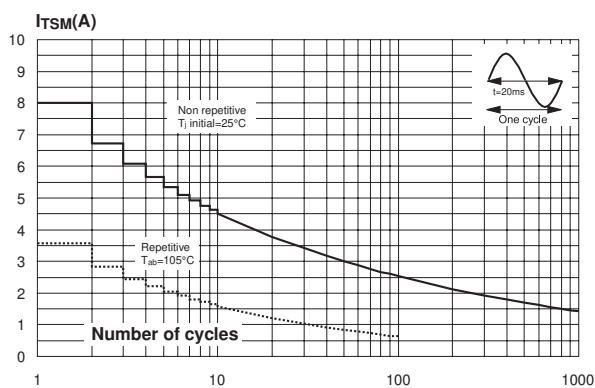

Fig. 9: Non repetitive surge peak on-state current for a sinusoidal pulse with width $t_p < 10\text{ms}$, and corresponding value of I^2t .

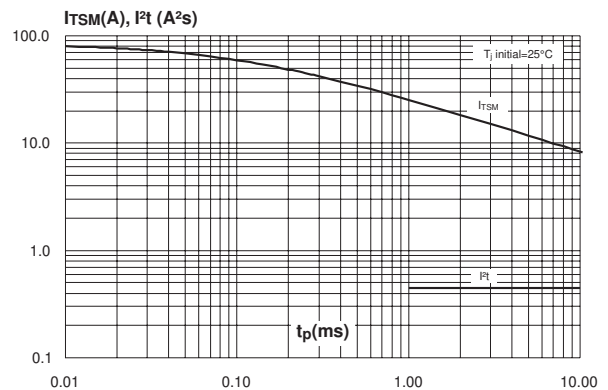

Fig. 10: On-state characteristics (maximum values).

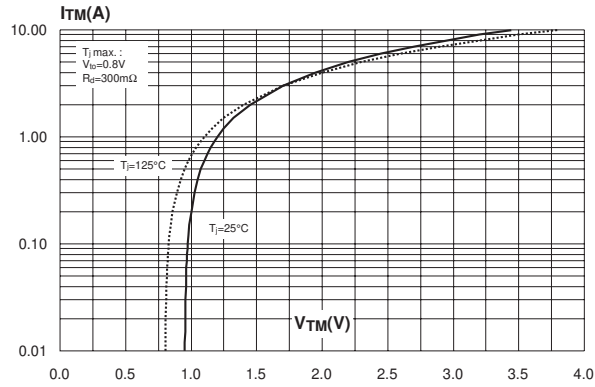
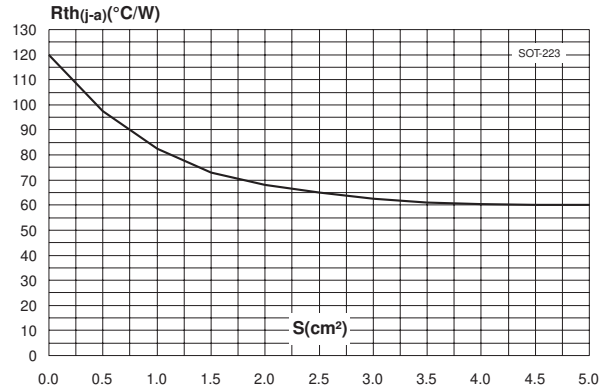
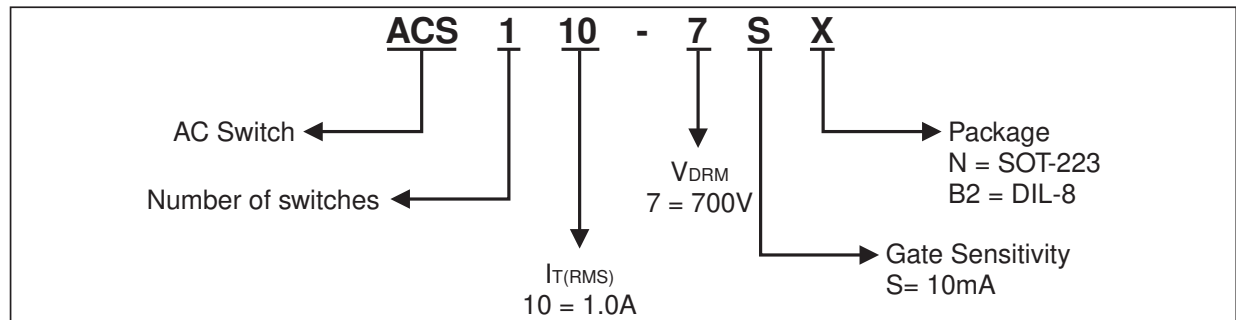

Fig. 11: Thermal resistance junction to ambient versus copper surface under tab (printed circuit board FR4, copper thickness: 35µm)



ORDERING INFORMATION



PACKAGE OUTLINE MECHANICAL DATA
SOT-223

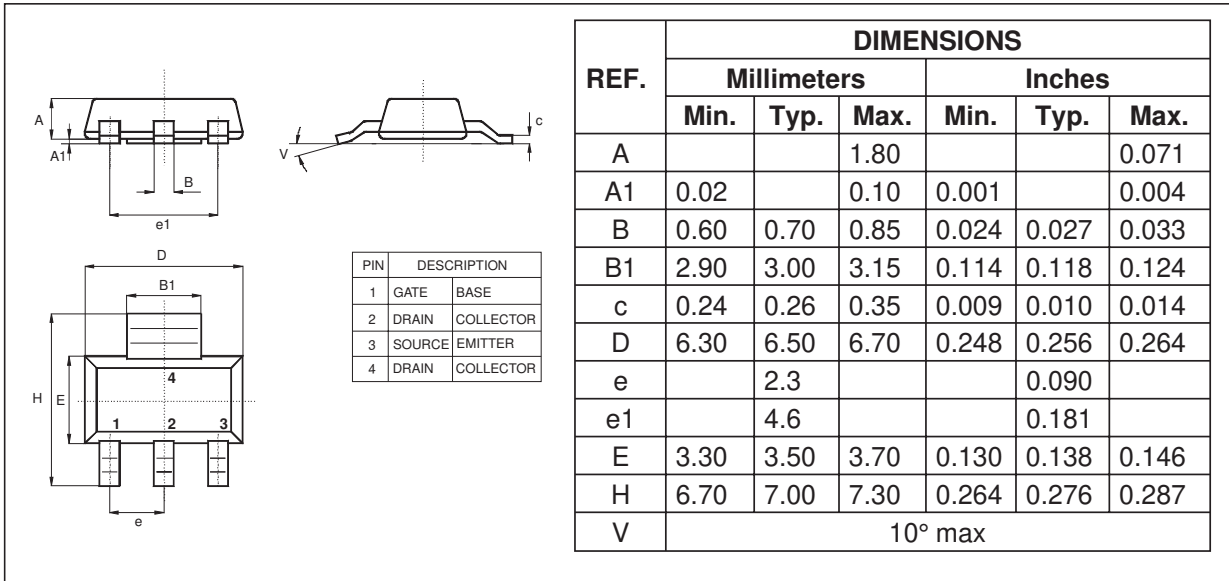

PACKAGE FOOT PRINT
SOT-223

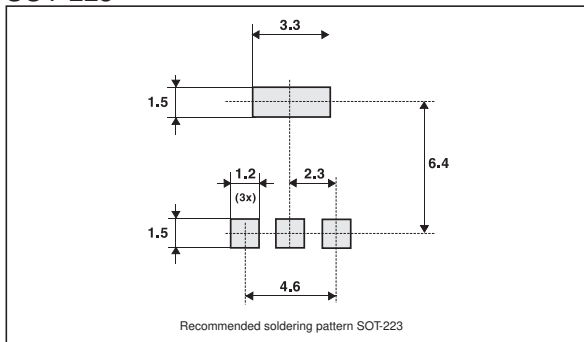

ACS110-7SN/SB2

PACKAGE OUTLINE MECHANICAL DATA DIL-8

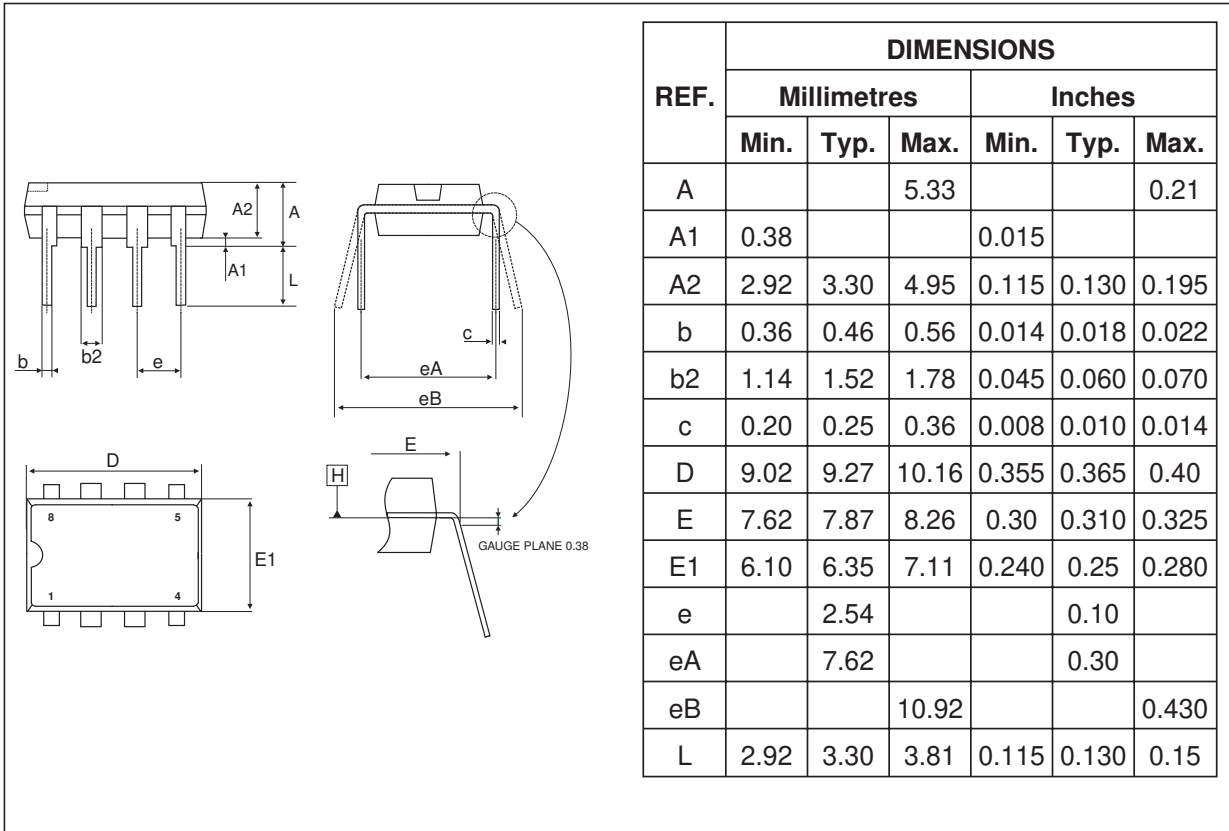

OTHER INFORMATION

Ordering type	Marking	Package	Weight	Base qty	Delivery mode
ACS110-7SN	ACS1107S	SOT-223	0.12 g	1000	Tape & reel
ACS110-7SB2	ACS1107S	DIL8	0.6 g	50	Tube

- Epoxy meets UL94,V0

Information furnished is believed to be accurate and reliable. However, STMicroelectronics assumes no responsibility for the consequences of use of such information nor for any infringement of patents or other rights of third parties which may result from its use. No license is granted by implication or otherwise under any patent or patent rights of STMicroelectronics. Specifications mentioned in this publication are subject to change without notice. This publication supersedes and replaces all information previously supplied. STMicroelectronics products are not authorized for use as critical components in life support devices or systems without express written approval of STMicroelectronics.

The ST logo is a registered trademark of STMicroelectronics
 © 2003 STMicroelectronics - Printed in Italy - All rights reserved.
 STMicroelectronics GROUP OF COMPANIES
 Australia - Brazil - Canada - China - Finland - France - Germany
 Hong Kong - India - Israel - Italy - Japan - Malaysia - Malta - Morocco - Singapore
 Spain - Sweden - Switzerland - United Kingdom - United States.

<http://www.st.com>

