



Chipsmall Limited consists of a professional team with an average of over 10 year of expertise in the distribution of electronic components. Based in Hongkong, we have already established firm and mutual-benefit business relationships with customers from,Europe,America and south Asia,supplying obsolete and hard-to-find components to meet their specific needs.

With the principle of “Quality Parts,Customers Priority,Honest Operation,and Considerate Service”,our business mainly focus on the distribution of electronic components. Line cards we deal with include Microchip,ALPS,ROHM,Xilinx,Pulse,ON,Everlight and Freescale. Main products comprise IC,Modules,Potentiometer,IC Socket,Relay,Connector.Our parts cover such applications as commercial,industrial, and automotives areas.

We are looking forward to setting up business relationship with you and hope to provide you with the best service and solution. Let us make a better world for our industry!



Contact us

Tel: +86-755-8981 8866 Fax: +86-755-8427 6832

Email & Skype: info@chipsmall.com Web: www.chipsmall.com

Address: A1208, Overseas Decoration Building, #122 Zhenhua RD., Futian, Shenzhen, China





FEATURES

- **Ideal relay for high output 3-phase motors (EPS)**
2-path cut-off (2 Form A) using single coil for 3-phase motors
- **High cut-off current capability**
High cut-off current performance (12V) using 2-point cut-off configuration
- **High carrying current performance**
High capacity achieved through use of high conductivity material
- **Highly heat resistance properties**
High heat resistance (at 125°C 257°F) through use of high heat resistance plastic

TYPICAL APPLICATIONS

- To 3-phase motor EPS unit (for failsafe circuit)

ORDERING INFORMATION

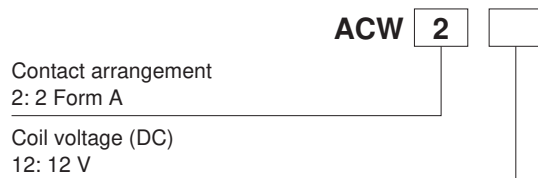

TYPES

Contact arrangement	Coil voltage	Part No.
2 Form A	12 V DC	ACW212

Standard packing; Carton: 40 pcs.; Case: 160 pcs.

RATING

1. Coil data

Nominal coil voltage	Pick-up voltage (at 20°C 68°F)	Drop-out voltage (at 20°C 68°F)	Nominal operating current [±10%] (at 20°C 68°F)	Coil resistance [±10%] (at 20°C 68°F)	Nominal operating power (at 20°C 68°F)	Usable voltage range
12V DC	Max. 6.2 V DC (Initial)	Min. 0.5 V DC (Initial)	117 mA	103Ω	1.4 W	10 to 16V DC

CW (ACW)

2. Specifications

Characteristics	Item	Specifications	
Contact	Arrangement	2 Form A	
	Contact resistance (Initial)	Typ. 1.2 mΩ (By voltage drop 6V DC 1A)	
	Contact material	Ag alloy (Cadmium free)	
Rating	Nominal switching capacity (at carrying current)	120 A 14V DC for 5 seconds (at 20°C 68°F)	
		70 A 14V DC for 1 minute (at 85°C 185°F)	
		45 A 14V DC for continuous (at 85°C 185°F)	
	Nominal operating power	1.4 W	
	Min. switching capacity (resistive load)*1	1 A 14V DC (at 20°C 68°F)	
Electrical characteristics	Insulation resistance (Initial)	Min. 100 MΩ (at 500V DC)	
	Breakdown voltage (Initial)	Between open contacts	500 Vrms for 1 min. (Detection current: 10mA)
		Between contacts and coil	500 Vrms for 1 min. (Detection current: 10mA)
	Operate time (at nominal voltage)	Max. 20ms (at 20°C 68°F, excluding contact bounce time) (Initial)	
	Release time (at nominal voltage)	Max. 20ms (at 20°C 68°F) (Initial) (without protective element)	
Mechanical characteristics	Shock resistance	Functional	Min. 200 m/s ² {approx. 20G} (Half-wave pulse of sine wave: 11ms; detection time: 10μs) (12 V DC applied to the coil, at 20°C 68°F)
		Destructive	Min. 1,000 m/s ² {approx. 100G} (Half-wave pulse of sine wave: 6ms)
	Vibration resistance	Functional	10 Hz to 500 Hz, Min. 44.1 m/s ² {approx. 4.5G} (Detection time: 10μs) (12 V DC applied to the coil, at 20°C 68°F)
		Destructive	10 Hz to 500 Hz, Min. 44.1 m/s ² {approx. 4.5G}, Time of vibration for each direction: X, Y, Z direction: 4 hours
Expected life	Mechanical	Min. 2 × 10 ⁵ (at 60 cpm)	
	Electrical (at cut off only)	200 A 14V DC (resistive load), Min. 3 times (without diode)	
Conditions	Conditions for operation, transport and storage*2	Ambient temperature: -40°C to +125°C -40°F to +257°F, Humidity: 5% R.H. to 85% R.H. (Not freezing and condensing at low temperature)	
Mass		Approx. 26 g .92 oz	

Notes:

*1.This value can change due to the switching frequency, environmental conditions, and desired reliability level, therefore it is recommended to check this with the actual load.

*2.The upper operation ambient temperature limit is the maximum temperature that can satisfy the coil temperature rise value. Refer to "6. Usage, Storage and Transport Conditions" in [AMBIENT ENVIRONMENT section in Relay Technical Information](#).

REFERENCE DATA

1.-(1) Coil temperature rise (25°C 77°F)

Sample: ACW212, 3pcs

Point measured: Inside the coil

Contact carrying current: 45A

Ambient temperature: 25°C 77°F

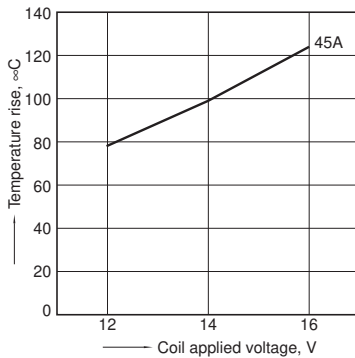

1.-(1) Coil temperature rise (85°C 185°F)

Sample: ACW212, 3pcs

Point measured: Inside the coil

Contact carrying current: 45A

Ambient temperature: 85°C 185°F

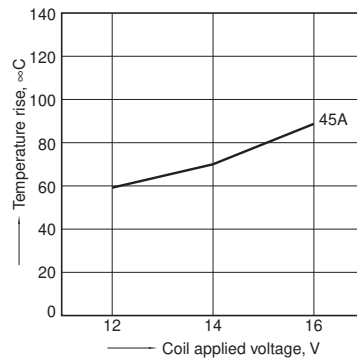

2. Distribution of pick-up and drop-out voltage

Sample: ACW212, 100pcs

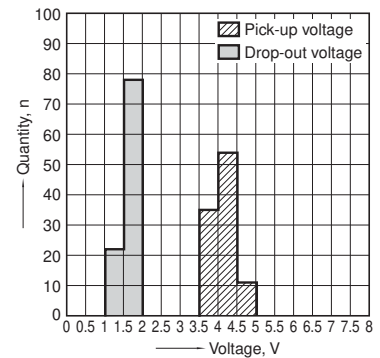

3. Distribution of operate and release time

Sample: ACW212, 100pcs.

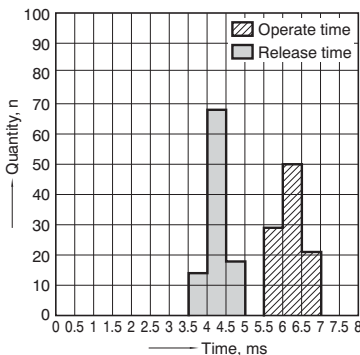

4. Ambient temperature and operating voltage range

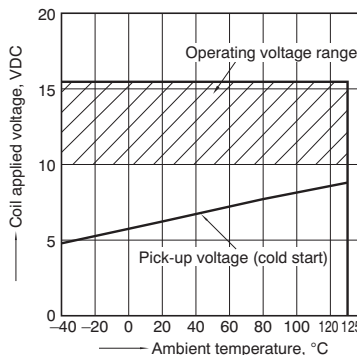

DIMENSIONS (mm inch)

Download [CAD Data](#) from our Web site.

CAD Data



External dimensions

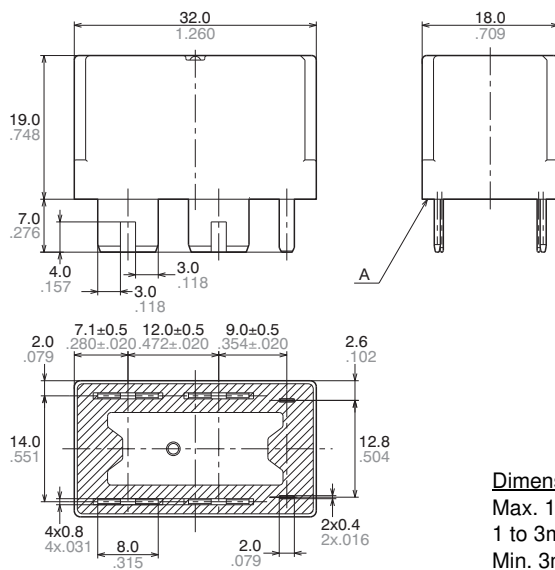

Schematic (Bottom view)

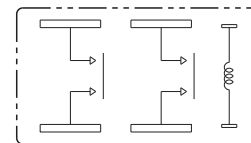

Dimension:	Tolerance
Max. 1mm .039 inch:	±0.1 ±.004
1 to 3mm .039 to .118 inch:	±0.2 ±.008
Min. 3mm .118 inch:	±0.3 ±.012

* Intervals between terminals is measured at A surface level.

NOTES

1. Mounting method

These relays are designed for mounting by welding. Soldering cannot be used for mounting.

2. Usage, transport and storage conditions

- 1) Ambient temperature, humidity, and atmospheric pressure during usage, transport, and storage of the relay:
 - (1) Temperature: -40 to +125°C -40 to +257°F
 - (2) Humidity: 2 to 85% RH (Avoid freezing and condensation.)
 - (3) Atmospheric pressure: 86 to 106 kPa
 The humidity range varies with the temperature. Use within the range indicated in the graph below. (Temperature and humidity range for usage, transport, and storage)

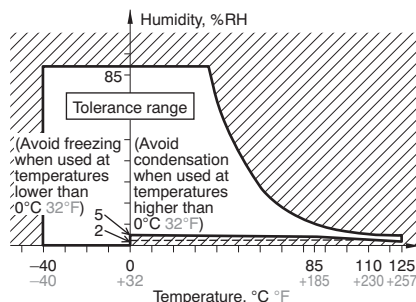

For Cautions for Use, see [Relay Technical Information](#).