



Chipsmall Limited consists of a professional team with an average of over 10 year of expertise in the distribution of electronic components. Based in Hongkong, we have already established firm and mutual-benefit business relationships with customers from,Europe,America and south Asia,supplying obsolete and hard-to-find components to meet their specific needs.

With the principle of “Quality Parts,Customers Priority,Honest Operation,and Considerate Service”,our business mainly focus on the distribution of electronic components. Line cards we deal with include Microchip,ALPS,ROHM,Xilinx,Pulse,ON,Everlight and Freescale. Main products comprise IC,Modules,Potentiometer,IC Socket,Relay,Connector.Our parts cover such applications as commercial,industrial, and automotives areas.

We are looking forward to setting up business relationship with you and hope to provide you with the best service and solution. Let us make a better world for our industry!



## Contact us

Tel: +86-755-8981 8866 Fax: +86-755-8427 6832

Email & Skype: info@chipsmall.com Web: www.chipsmall.com

Address: A1208, Overseas Decoration Building, #122 Zhenhua RD., Futian, Shenzhen, China



## ACZRC5340B-G Thru. ACZRC5388B-G

Voltage: 6.0 to 200 Volts

Power: 5 Watts

RoHS Device

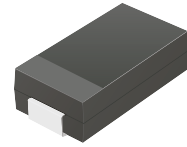

### Features

- Glass passivated chip.
- Low leakage.
- Built-in strain relief.
- Low inductance.
- High peak reverse power dissipation.
- For use in stabilizing and clipping circuits with high power.
- Comply with AEC-Q101

### Mechanical data

- Case: DO-214AB(SMC), Molded plastic.
- Epoxy: UL 94V-0 rate flame retardant.
- Terminals: Solderable per MIL-STD-750 ,method 2026 guranteed.
- Polarity: Color band denotes cathode.
- Mounting position: Any.
- Weight: Approx. 0.21 grams.

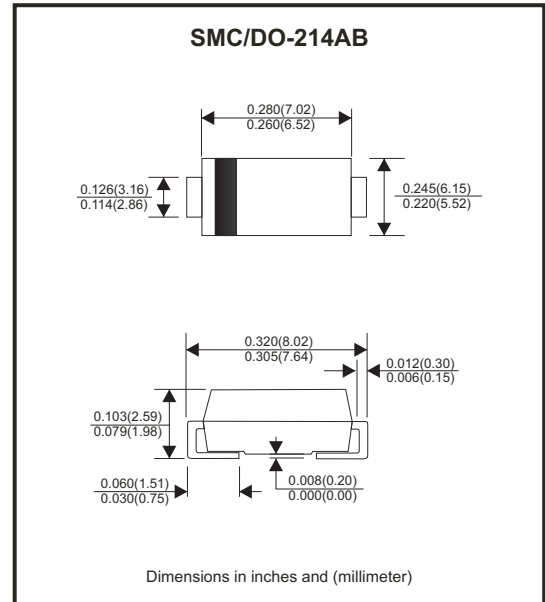

### Circuit diagram



### Maximum Ratings (TA=25°C unless otherwise noted)

Parameter	Symbol	Value	Unit
DC Power Dissipation, TL = 75°C (Note1)	P <sub>D</sub>	5	W
Maximun Forward voltage at I <sub>F</sub> =1A	V <sub>F</sub>	1.2	V
Junction and Storage Temperature Range	T <sub>J</sub> ,T <sub>STG</sub>	-55 to +150	°C

(1) TL = Lead temperature at 3/8" (9.5mm) from body.

## Electrical Characteristics (at TA=25°C unless otherwise specified)

Part Number	Nominal Zener Voltage		Maximum Zener Impedance			Maximum Reverse Leakage Current		Maximum DC Zener Current	Marking Code
	VZ @ IZT	IZT	ZZT @ IZT	ZZK @ IZK	IZK	IR @ VR		IZM	
	(V)	(mA)	(Ohm)	(Ohm)	(mA)	(uA)	(V)	(mA)	
ACZRC5340B-G	6.0	200	1.0	300	1	1.0	3.0	790.0	340B
ACZRC5341B-G	6.2	200	1.0	200	1	1.0	3.0	765.0	341B
ACZRC5342B-G	6.8	175	1.0	200	1	10.0	5.2	700.0	342B
ACZRC5343B-G	7.5	175	1.5	200	1	10.0	5.7	630.0	343B
ACZRC5344B-G	8.2	150	1.5	200	1	10.0	6.2	580.0	344B
ACZRC5345B-G	8.7	150	2.0	200	1	10.0	6.6	545.0	345B
ACZRC5346B-G	9.1	150	2.0	150	1	7.5	6.9	520.0	346B
ACZRC5347B-G	10.0	125	2.0	125	1	5.0	7.6	475.0	347B
ACZRC5348B-G	11.0	125	2.5	125	1	5.0	8.4	430.0	348B
ACZRC5349B-G	12.0	100	2.5	125	1	2.0	9.1	395.0	349B
ACZRC5350B-G	13.0	100	2.5	100	1	1.0	9.9	365.0	350B
ACZRC5351B-G	14.0	100	2.5	75	1	1.0	10.6	340.0	351B
ACZRC5352B-G	15.0	75	2.5	75	1	1.0	11.5	315.0	352B
ACZRC5353B-G	16.0	75	2.5	75	1	1.0	12.2	295.0	353B
ACZRC5354B-G	17.0	70	2.5	75	1	0.5	12.9	280.0	354B
ACZRC5355B-G	18.0	65	2.5	75	1	0.5	13.7	265.0	355B
ACZRC5356B-G	19.0	65	3.0	75	1	0.5	14.4	250.0	356B
ACZRC5357B-G	20.0	65	3.0	75	1	0.5	15.2	237.0	357B
ACZRC5358B-G	22.0	50	3.5	75	1	0.5	16.7	216.0	358B
ACZRC5359B-G	24.0	50	3.5	100	1	0.5	18.2	198.0	359B
ACZRC5360B-G	25.0	50	4.0	110	1	0.5	19.0	190.0	360B
ACZRC5361B-G	27.0	50	5.0	120	1	0.5	20.6	176.0	361B
ACZRC5362B-G	28.0	50	6.0	130	1	0.5	21.2	170.0	362B
ACZRC5363B-G	30.0	40	8.0	140	1	0.5	22.8	158.0	363B
ACZRC5364B-G	33.0	40	10.0	150	1	0.5	25.1	144.0	364B
ACZRC5365B-G	36.0	30	11.0	160	1	0.5	27.4	132.0	365B
ACZRC5366B-G	39.0	30	14.0	170	1	0.5	29.7	122.0	366B
ACZRC5367B-G	43.0	30	20.0	190	1	0.5	32.7	110.0	367B
ACZRC5368B-G	47.0	25	25.0	210	1	0.5	35.8	100.0	368B
ACZRC5369B-G	51.0	25	27.0	230	1	0.5	38.8	93.0	369B
ACZRC5370B-G	56.0	20	35.0	280	1	0.5	42.6	86.0	370B
ACZRC5371B-G	60.0	20	40.0	350	1	0.5	45.5	79.0	371B
ACZRC5372B-G	62.0	20	42.0	400	1	0.5	47.1	76.0	372B
ACZRC5373B-G	68.0	20	44.0	500	1	0.5	51.7	70.0	373B
ACZRC5374B-G	75.0	20	45.0	620	1	0.5	56.0	63.0	374B
ACZRC5375B-G	82.0	15	65.0	720	1	0.5	62.2	58.0	375B
ACZRC5376B-G	87.0	15	75.0	760	1	0.5	66.0	54.5	376B
ACZRC5377B-G	91.0	15	75.0	760	1	0.5	69.2	52.5	377B

**Notes:**

- (1) The type number listed have a standard tolerance on the nominal zener voltage of  $\pm 5\%$ .
- (2) The reverse surge current is a non-repetitive, 8.3ms pulse width square wave or equivalent sine-wave superimposed on IZT per JEDEC Method.



## Electrical Characteristics (at TA=25°C unless otherwise specified)

Part Number	Nominal Zener Voltage		Maximum Zener Impedance			Maximum Reverse Leakage Current		Maximum DC Zener Current	Marking Code
	VZ @ IZT	IZT	ZZT @ IZT	ZZK @ IZK	IZK	IR @ VR	IZM		
	(V)	(mA)	(Ohm)	(Ohm)	(mA)	(uA)	(V)	(mA)	
ACZRC5378B-G	100.0	12	90.0	800	1	0.5	76.0	47.5	378B
ACZRC5379B-G	110.0	12	125.0	1000	1	0.5	83.6	43.0	379B
ACZRC5380B-G	120.0	10	170.0	1150	1	0.5	91.2	39.5	380B
ACZRC5381B-G	130.0	10	190.0	1250	1	0.5	98.8	36.6	381B
ACZRC5382B-G	140.0	8	230.0	1500	1	0.5	106.0	34.0	382B
ACZRC5383B-G	150.0	8	330.0	1500	1	0.5	114.0	31.6	383B
ACZRC5384B-G	160.0	8	335.0	1650	1	0.5	122.0	29.4	384B
ACZRC5385B-G	170.0	8	380.0	1750	1	0.5	129.0	28.0	385B
ACZRC5386B-G	180.0	5	430.0	1750	1	0.5	137.0	26.4	386B
ACZRC5387B-G	190.0	5	450.0	1850	1	0.5	144.0	25.0	387B
ACZRC5388B-G	200.0	5	480.0	1850	1	0.5	152.0	23.6	388B

**Notes:**

- (1) The type number listed have a standard tolerance on th nominal zener voltage of  $\pm 5\%$ .
- (2) The reverse surge current is a non-repetitive, 8.3ms pulse width square wave or equivalent sine-wave superimposed on IZT per JEDEC Method.

## RATING AND CHARACTERISTIC CURVES (ACZRC5340B-G Thru. ACZRC5388B-G)

Fig.1- Power temperature derating current

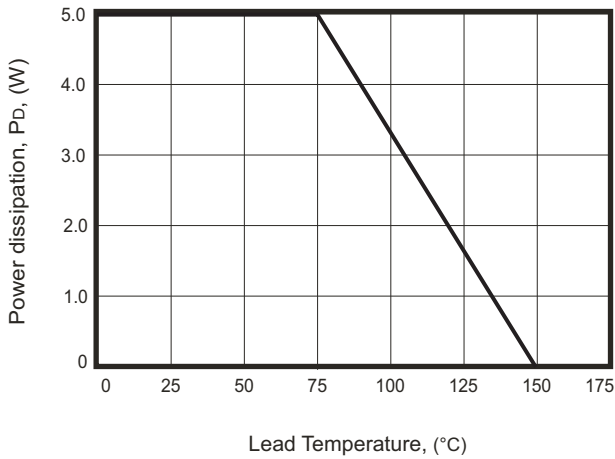

Fig.2- Temperature coefficients v.s. Zener voltage

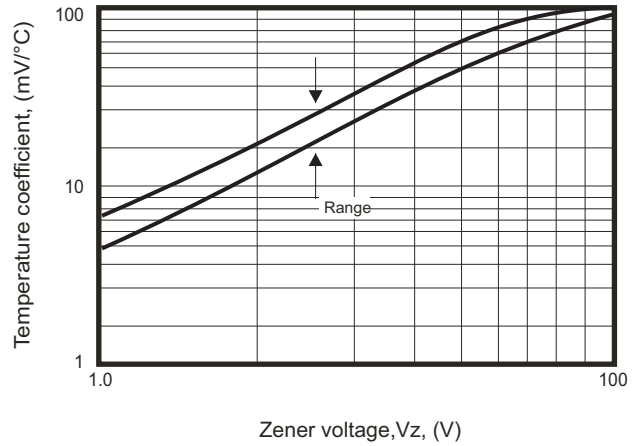

Fig.3- Typical thermal resistance v.s. lead length

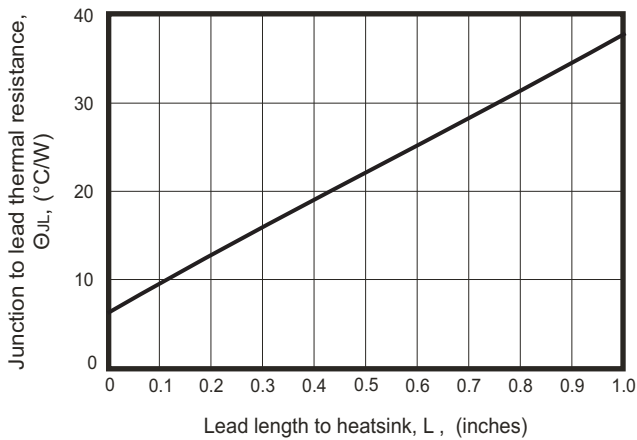

Fig.4 - Maximum surge power

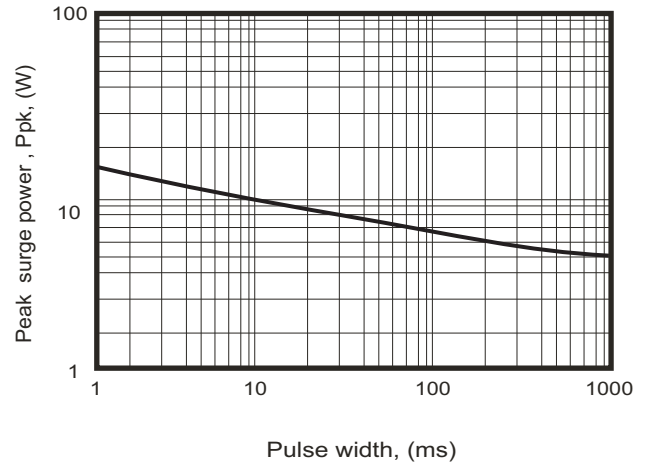
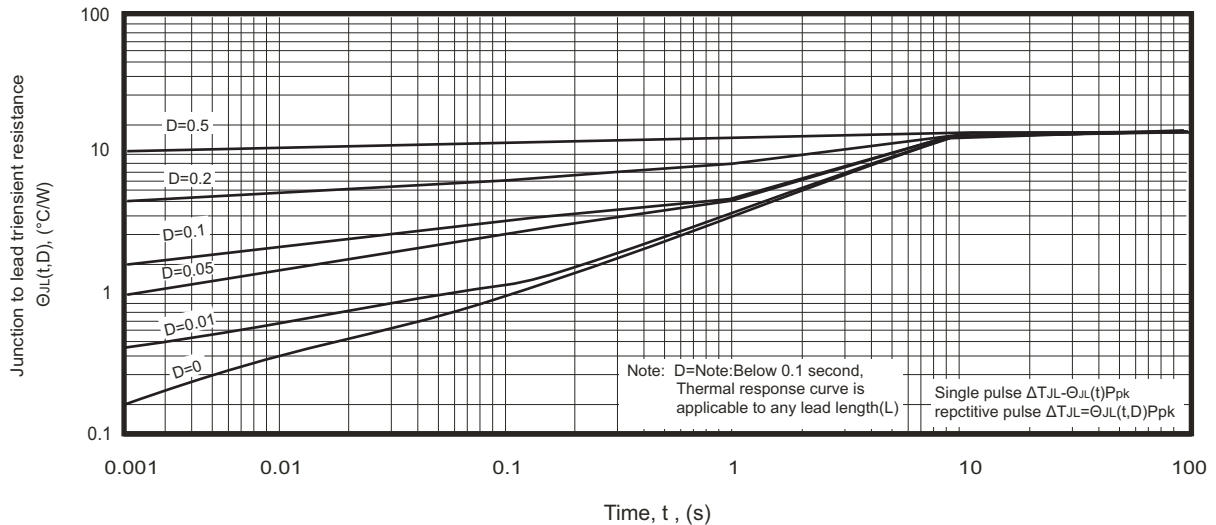
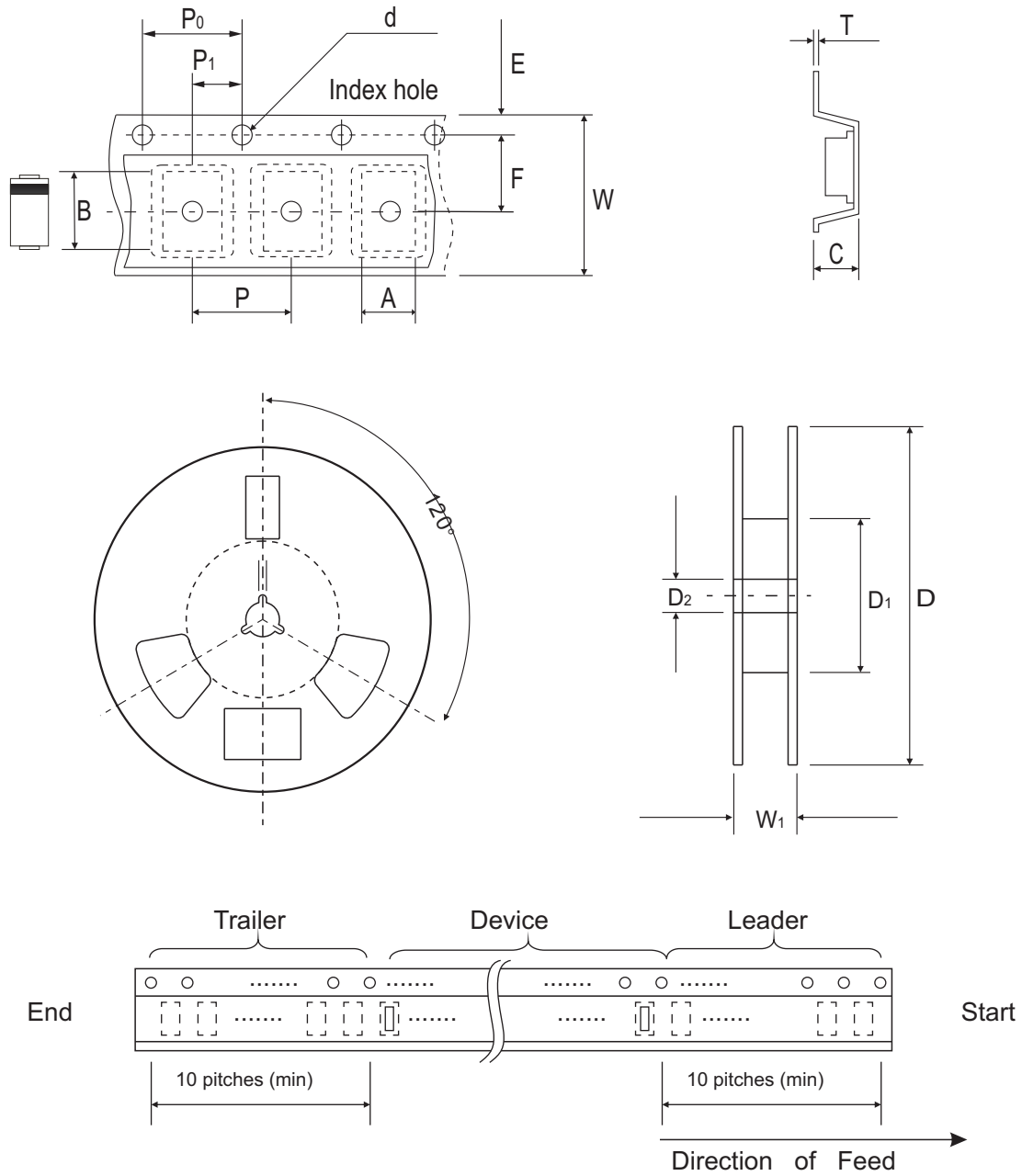

Fig.5- Typical thermal response  $L$ , lead length=3/8 inch



## Reel Taping Specification



DO-214AB (SMC)	SYMBOL	A	B	C	d	D	D1	D2
	(mm)	6.05 ± 0.10	8.31 ± 0.10	3.29 (max)	1.55 + 0.10	330.00	50.00 (min)	13.00 ± 0.20
	(inch)	0.238 ± 0.004	0.327 ± 0.004	0.130 (max)	0.061 + 0.004	13.000	1.969 (min)	0.512 ± 0.008

DO-214AB (SMC)	SYMBOL	E	F	P	P0	P1	W	W1
	(mm)	1.75 ± 0.10	7.50 ± 0.10	8.00 ± 0.10	4.00 ± 0.10	2.00 ± 0.10	16.00 ± 0.30	22.40 (max)
	(inch)	0.069 ± 0.004	0.295 ± 0.004	0.315 ± 0.004	0.157 ± 0.004	0.079 ± 0.004	0.630 ± 0.012	0.882 (max)

## Marking Code

Part Number	Marking Code
ACZRC5340B-G Thru. ACZRC5388B-G Series	XXX



3. XXX: Marking code (see Page.3~4)

4. █ : Cathod Band

## Suggested PAD Layout

SIZE	DO-214AB(SMC)	
	(mm)	(inch)
A	6.20	0.244
B	1.60	0.063
C	4.80	0.189
D	7.80	0.307
E	4.60	0.181

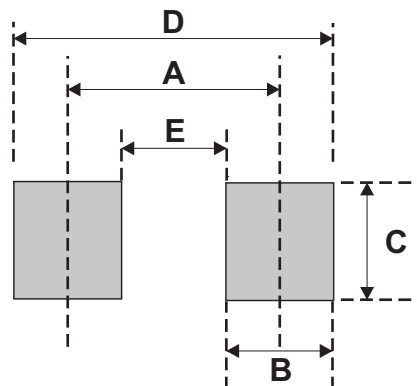

## Standard Packaging

Case Type	REEL PACK	
	REEL ( pcs )	Reel Size (inch)
DO-214AB (SMC)	3,000	13